

HC05

MC68HC05C4, C8, C9

MC68HC705C8

MC68HC805C4

MC68HCL05C4, C8

MC68HSC05C4, C8

PROGRAMMING

REFERENCE

GUIDE



The MC68HC05 Family of HCMOS devices covered in this reference guide are as follows:

MC68HC05C4
MC68HC05C8
MC68HC05C9
MC68HC705C8
MC68HC805C4
MC68HCL05C4
MC68HCL05C8
MC68HSC05C4
MC68HSC05C8

BLOCK DIAGRAMS



MEMORY MAPS



**REGISTER/CONTROL
BIT ASSIGNMENTS**



**INSTRUCTIONS
ADDRESSING MODES
EXECUTION TIMES**



MECHANICAL DATA



**HEX/DEC CONVERSION
ASCII CHART**





BLOCK DIAGRAMS



MEMORY MAPS



**REGISTER/CONTROL
BIT ASSIGNMENTS**



**INSTRUCTIONS
ADDRESSING MODES
EXECUTION TIMES**



MECHANICAL DATA



**HEX/DEC CONVERSION
ASCII CHART**

Freescale Semiconductor, Inc.
MC68HC05C4
MC68HCL05C4
MC68HSC05C4
BLOCK DIAGRAM

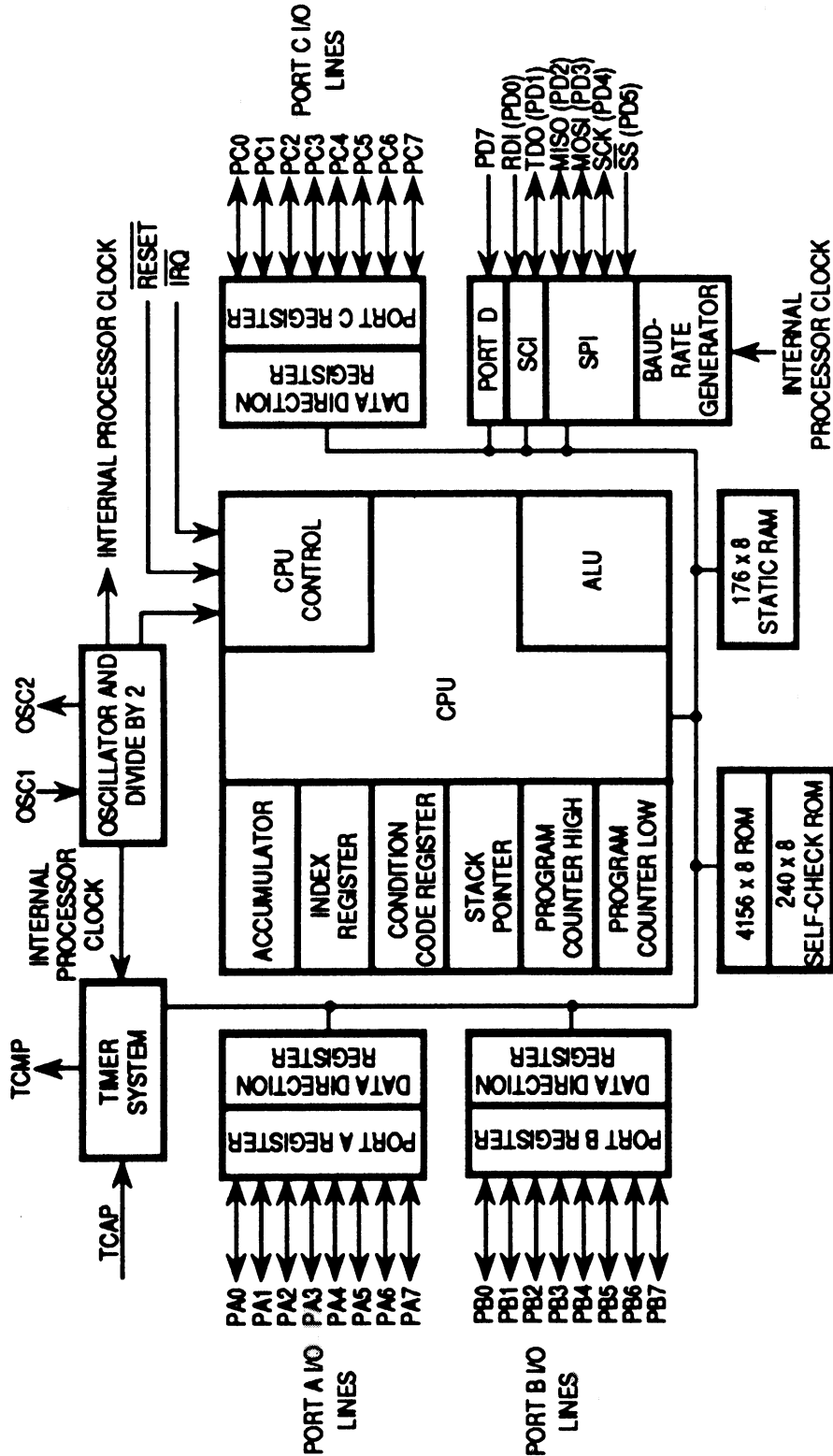

Freescale Semiconductor, Inc.
MC68HC05C8
MC68HCL05C8
MC68HSC05C8
BLOCK DIAGRAM

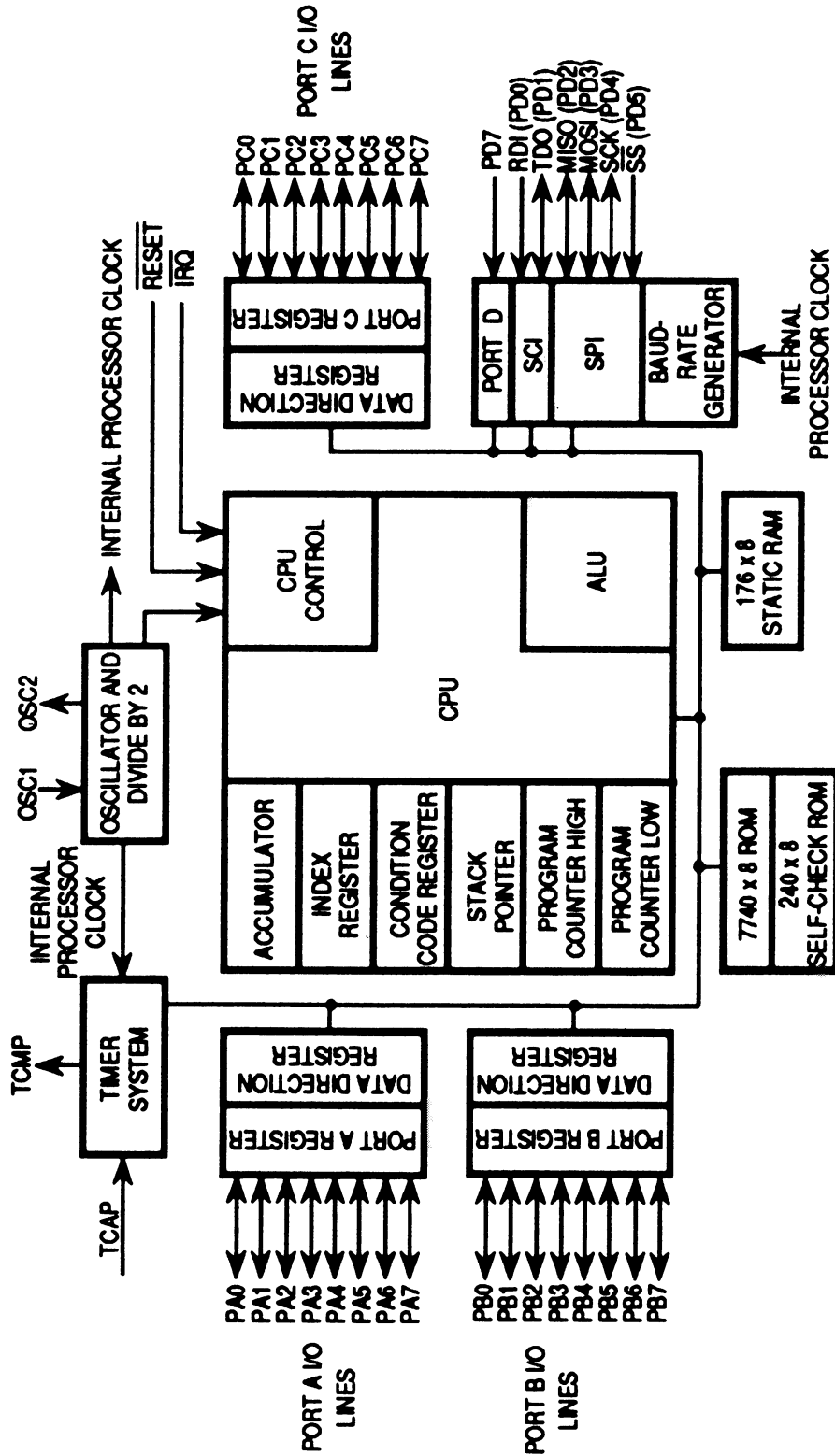

Freescale Semiconductor, Inc.

MC68HC05C9

BLOCK DIAGRAM

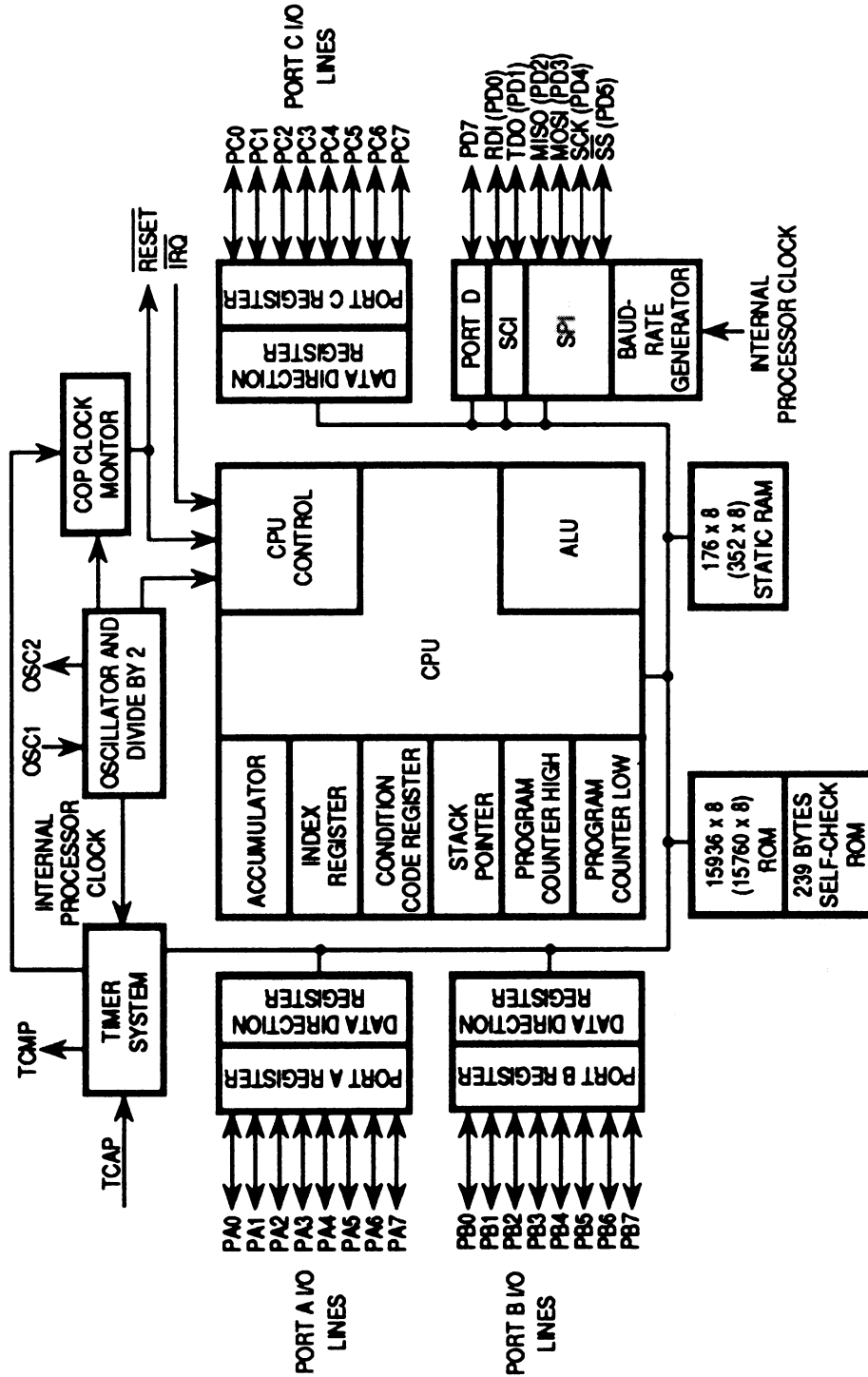

Freescale Semiconductor, Inc.

MC68HC705C8

BLOCK DIAGRAM

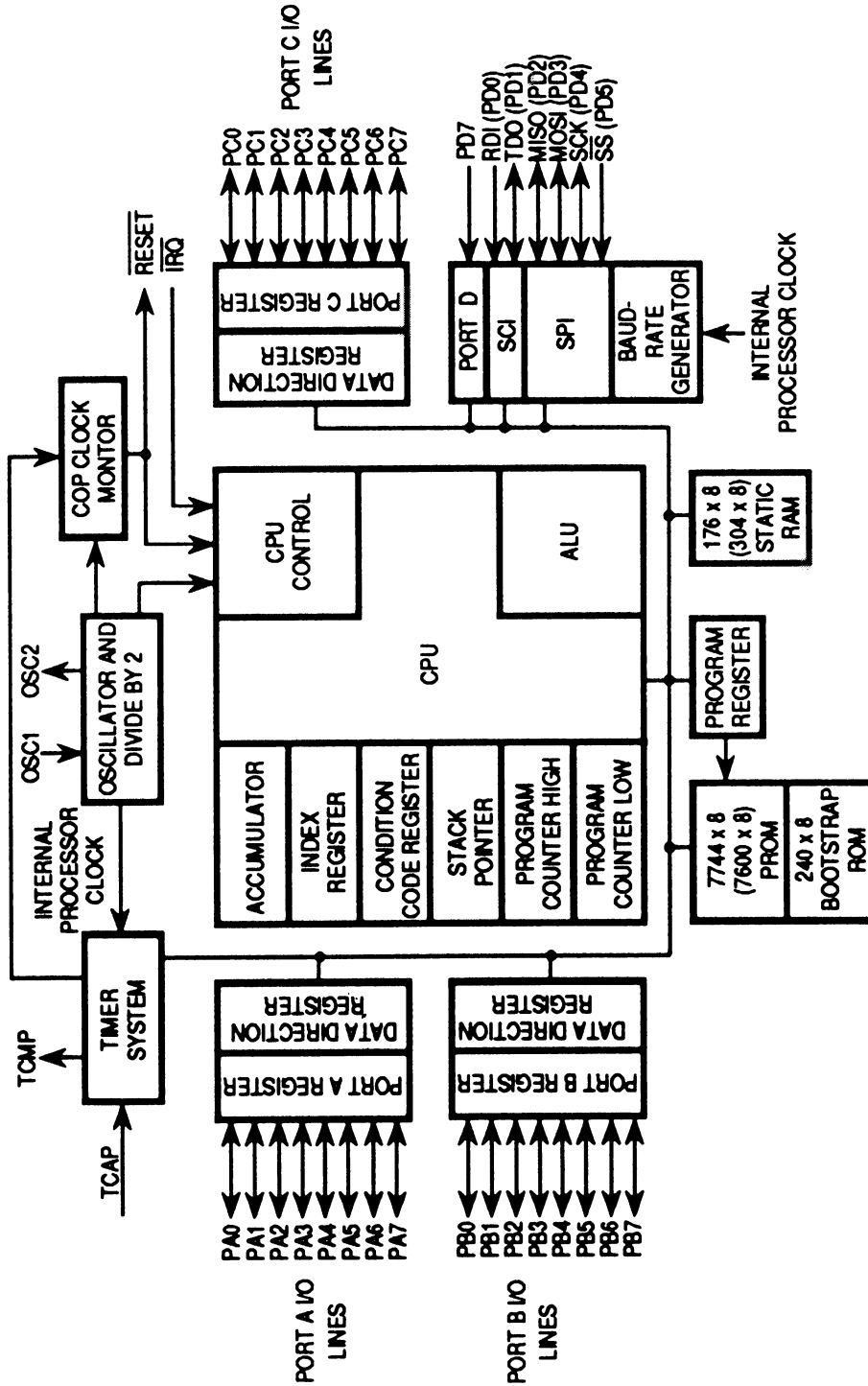

Freescale Semiconductor, Inc.

MC68HC805C4

BLOCK DIAGRAM

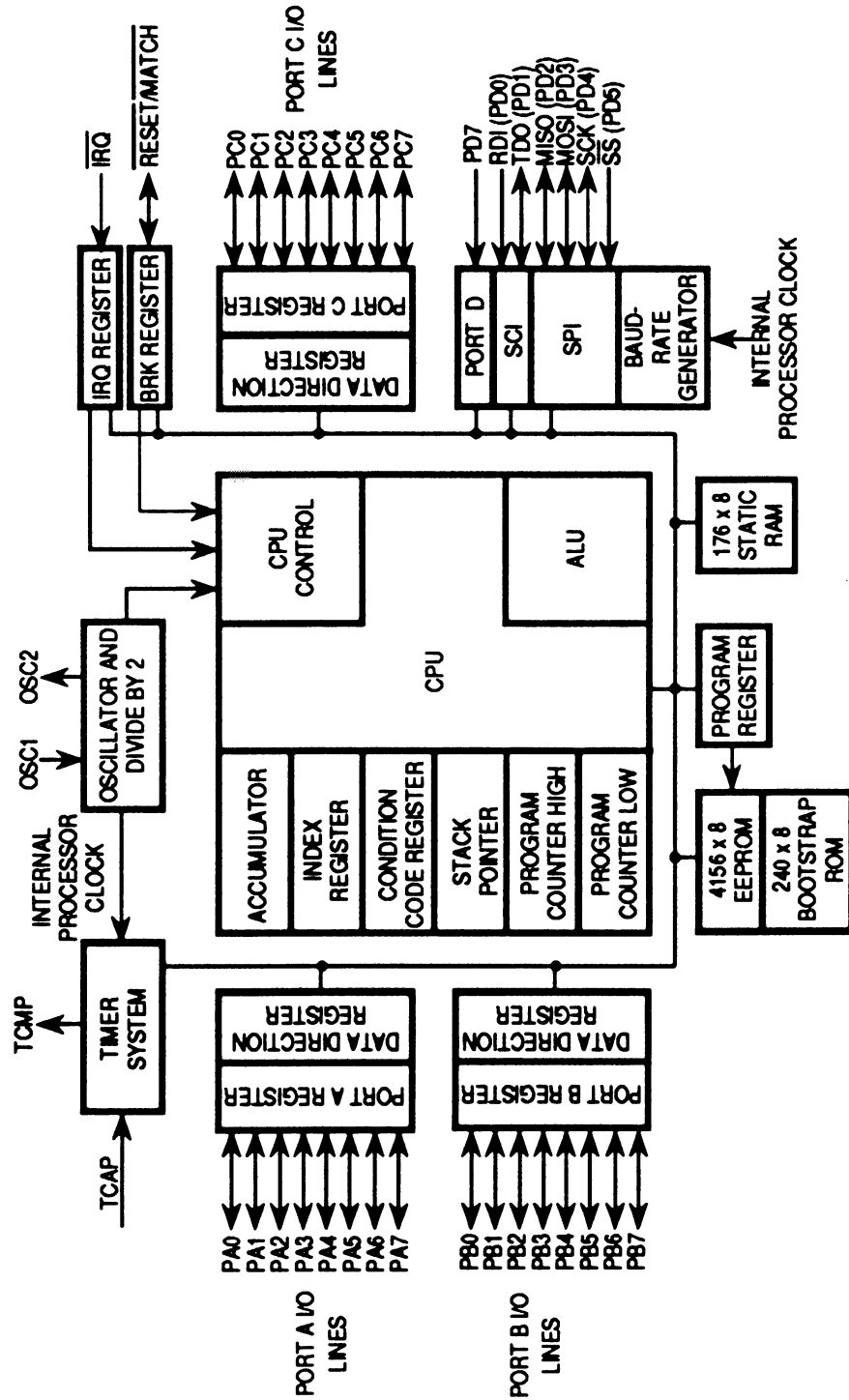

Freescale Semiconductor, Inc.
MC68HC05C4
MC68HCL05C4
MC68HSC05C4
MEMORY MAP

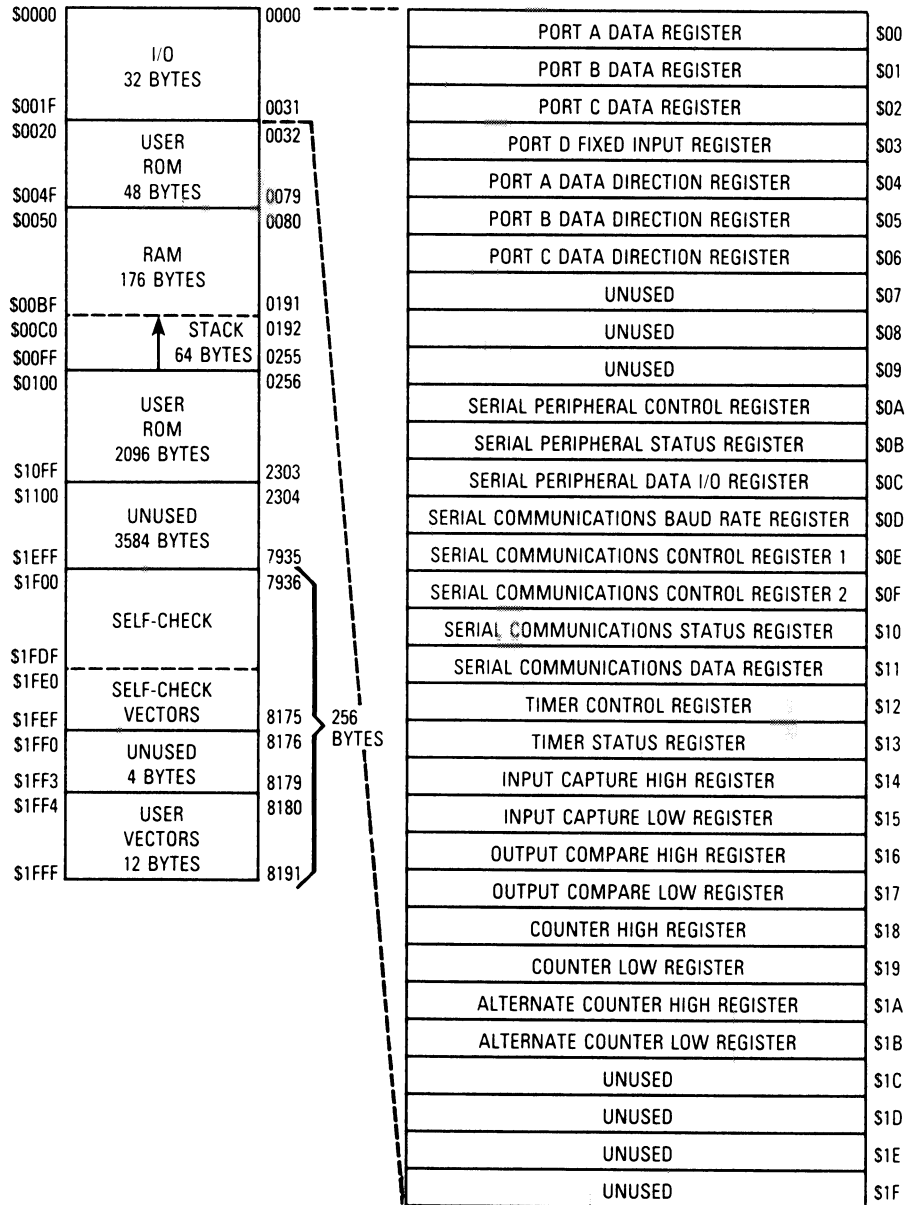

Freescale Semiconductor, Inc.

MC68HC05C8
MC68HCL05C8
MC68HSC05C8
MEMORY MAP

Freescale Semiconductor, Inc.

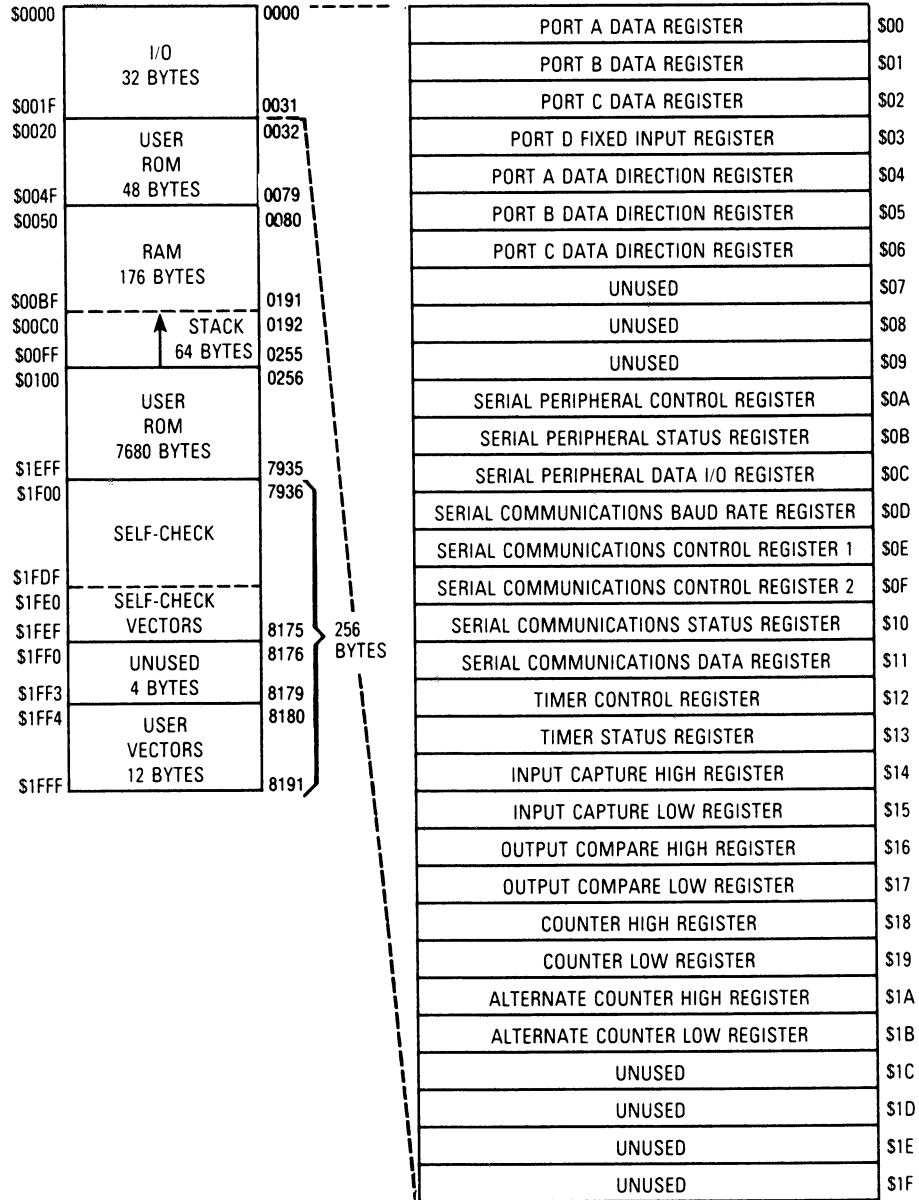

Freescale Semiconductor, Inc.

MC68HC05C9

MEMORY MAP

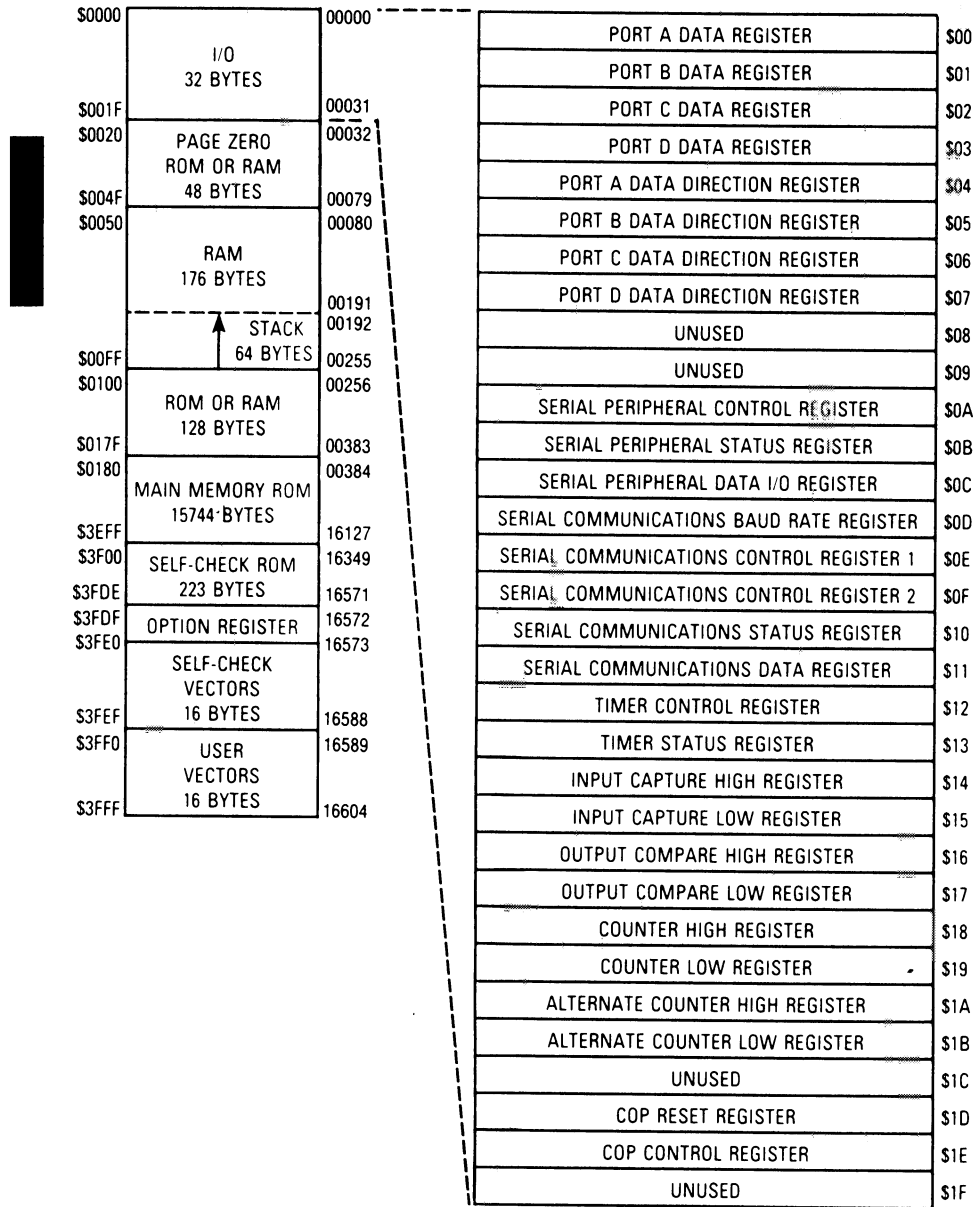

Freescale Semiconductor, Inc.

Freescale Semiconductor, Inc.

MC68HC705C8

MEMORY MAP

Freescale Semiconductor, Inc.

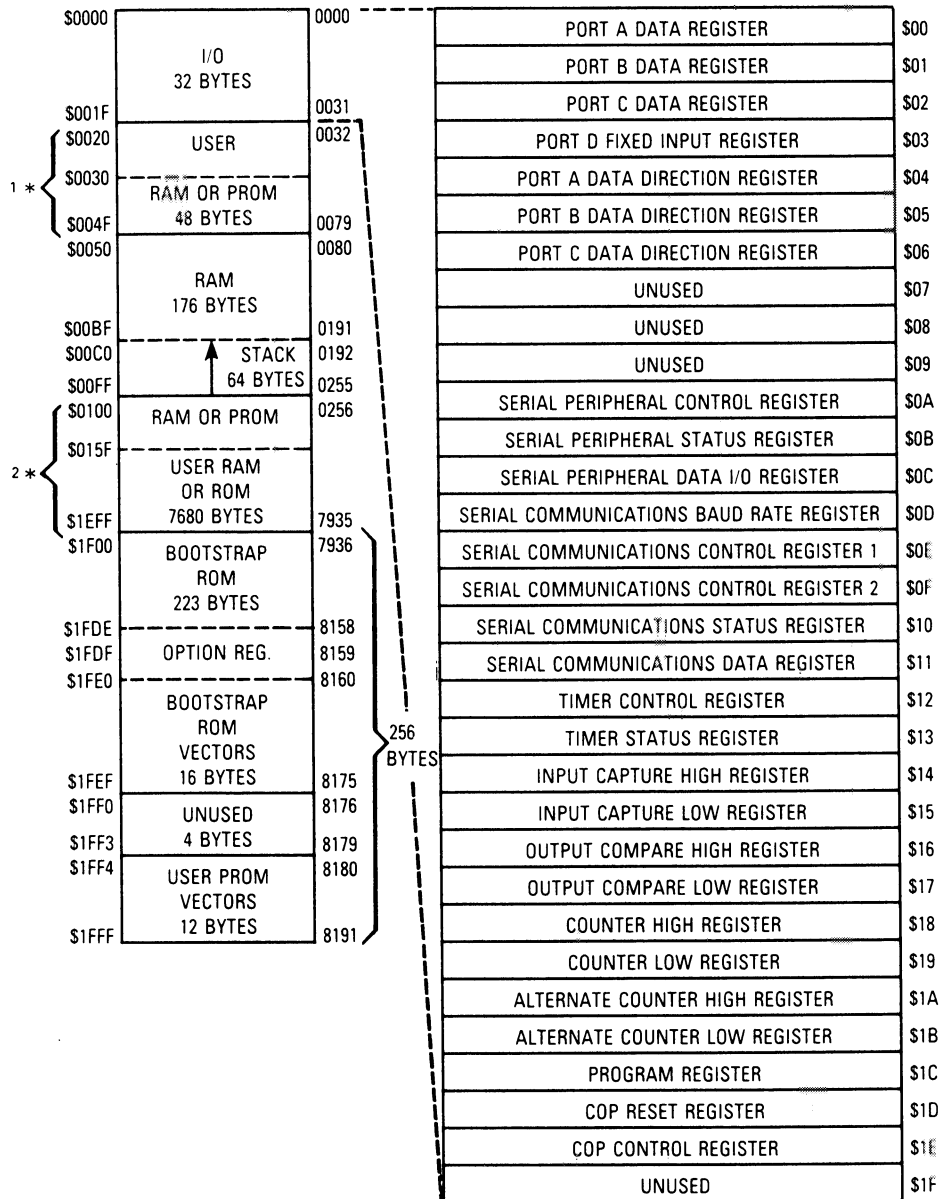

(Option Register \$1FDF RAM1=0 and RAM0=0) (POR or Master Reset)

*The nature of this memory block (RAM or PROM) is controlled by bits RAM0 and RAM1 of the Option Register (\$1FDF).

1. RAM0 0 — 48 Bytes User PROM
RAM0 1 — 32 Bytes RAM with 16 Bytes Unused

2. RAM1 0 — 7680 Bytes User PROM
RAM1 1 — 7584 Bytes User PROM and 96 Bytes of RAM

**For More Information On This Product,
Go to: www.freescale.com**

Freescale Semiconductor, Inc.
MC68HC805C4
MEMORY MAP

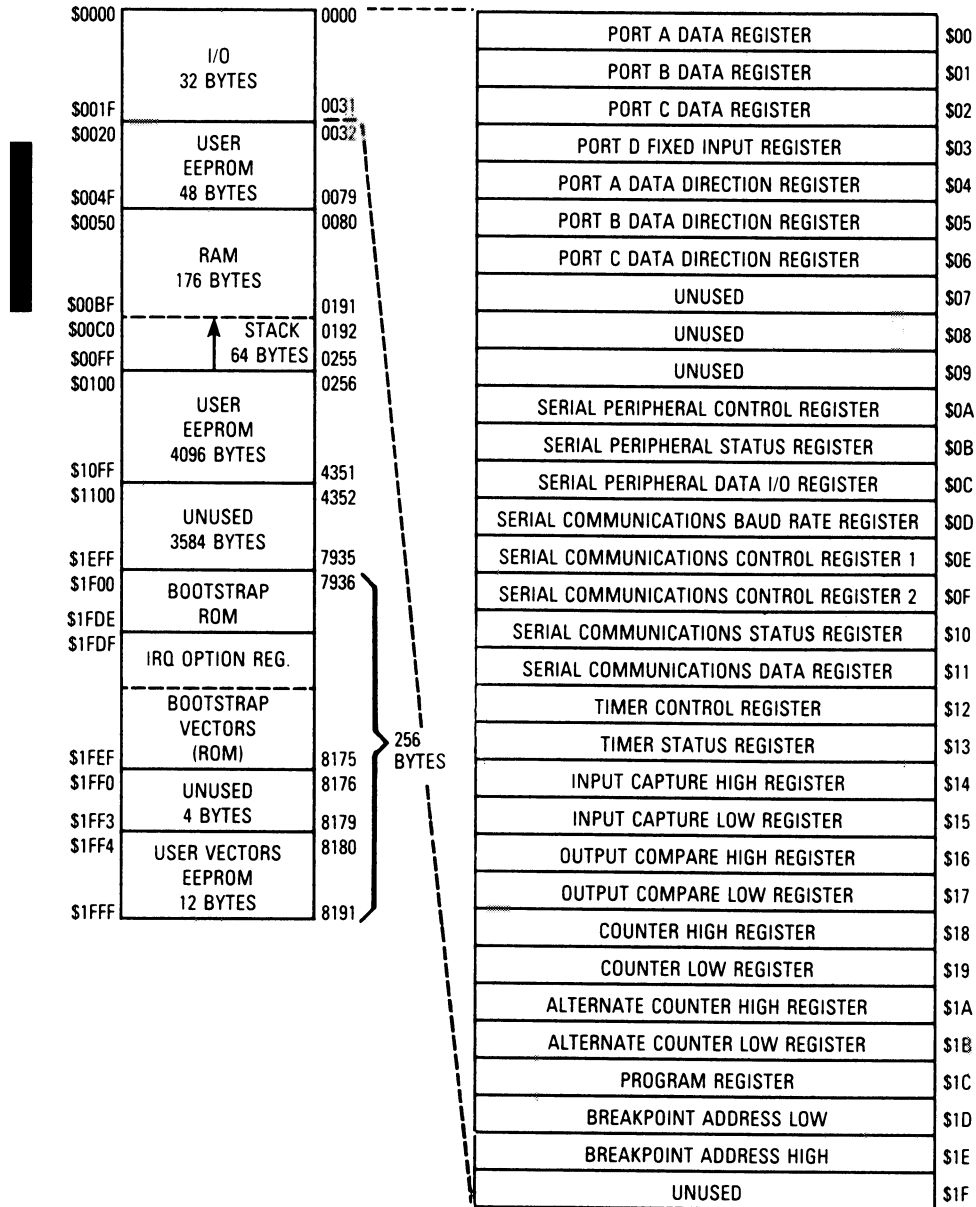

Freescale Semiconductor, Inc.

Freescale Semiconductor, Inc. PROGRAMMING MODEL INTERRUPT STACKING ORDER

PROGRAMMING MODEL

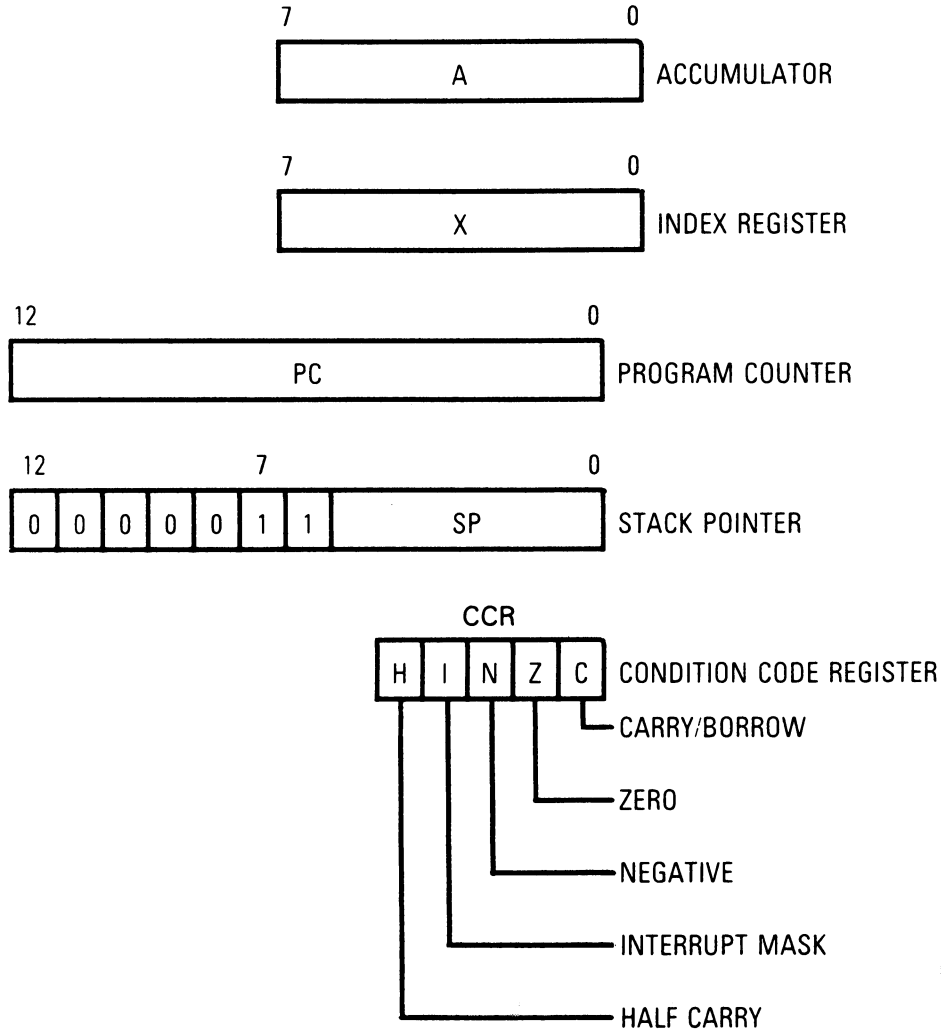

INTERRUPT STACKING ORDER

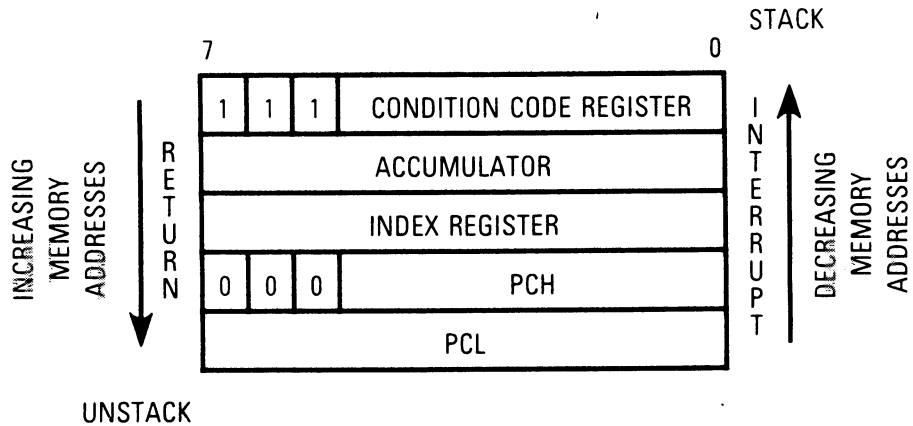

NOTE: Since the Stack Pointer decrements during pushes, the PCL is stacked first, followed by PCH, etc. Pulling from the stack is in the reverse order. **For More Information On This Product, Go to: www.freescale.com**

Freescale Semiconductor, Inc.
REGISTER AND CONTROL
BIT SUMMARY

	BIT		BIT		BIT		BIT		
	7	6	5	4	3	2	1	0	
\$00	PA7	PA6	PA5	PA4	PA3	PA2	PA1	PA0	PORTA
\$01	PB7	PB6	PB5	PB4	PB3	PB2	PB1	PB0	PORTB
\$02	PC7	PC6	PC5	PC4	PC3	PC2	PC1	PC0	PORT C
\$03	PD7/*		PD5/*	PD4/*	PD3/*	PD2/*	PD1/*	PD0/*	PORTD
\$04	DDA7	DDA6	DDA5	DDA4	DDA3	DDA2	DDA1	DDA0	DDRA
\$05	DDB7	DDB6	DDB5	DDB4	DDB3	DDB2	DDB1	DDB0	DDRB
\$06	DDC7	DDC6	DDC5	DDC4	DDC3	DDC2	DDC1	DDC0	DDRC
\$07	DDD7		DDD5	DDD4	DDD3	DDD2	DDD1	DDD0	DDRD [†]
\$08									UNUSED
\$09									UNUSED
\$0A	SPIE	SPE	DWOM [†]	MSTR	CPOL	CPHA	SPR1	SPR0	SPCR
\$0B	SPIF	WCOL		MODF					SPSR
\$0C	SPD7	SPD6	SPD5	SPD4	SPD3	SPD2	SPD1	SPD0	SPDR
\$0D			SCP1	SCP0		SCR2	SCR1	SCR0	BAUD
\$0E	R8	T8		M	WAKE				SCCR1
\$0F	TIE	TCIE	RIE	ILIE	TE	RE	RWU	SBK	SCCR2
\$10	TDRE	TC	RDRF	IDLE	OR	NF	FE		SCSR
\$11	SCD7	SCD6	SCD5	SCD4	SCD3	SCD2	SCD1	SCD0	SCDAT
\$12	ICIE	OCIE	TOIE	0	0	0	IEDG	OLVL	TCR
\$13	ICF	OCF	TOF	0	0	0	0	0	TSR
\$14	ICH7	ICH6	ICH5	ICH4	ICH3	ICH2	ICH1	ICH0	ICHR
\$15	ICL7	ICL6	ICL5	ICL4	ICL3	ICL2	ICL1	ICL0	ICLR
\$16	OCH7	OCH6	OCH5	OCH4	OCH3	OCH2	OCH1	OCH0	OCHR
\$17	OCL7	OCL6	OCL5	OCL4	OCL3	OCL2	OCL1	OCL0	OCLR
\$18	CH7	CH6	CH5	CH4	CH3	CH2	CH1	CH0	CHR
\$19	CL7	CL6	CL5	CL4	CL3	CL2	CL1	CL0	CLR
\$1A	ACH7	ACH6	ACH5	ACH4	ACH3	ACH2	ACH1	ACH0	ACHR
\$1B	ACL7	ACL6	ACL5	ACL4	ACL3	ACL2	ACL1	ACL0	ACLR
\$1C									UNUSED
\$1D									UNUSED
\$1E									UNUSED
\$1F									UNUSED

*Denotes fixed input port, see following page.

[†]MC68HC05C9 only

**For More Information On This Product,
 Go to: www.freescale.com**

Freescale Semiconductor, Inc.

REGISTER AND CONTROL BIT SUMMARY

	BIT 7	6	5	4	3	2	1	BIT 0	
S03	PD7		PD5	PD4	PD3	PD2	PD1	PD0	PORTD
			\overline{SS}	SCK	MOSI	MISO	TDO	RDI	

(PORT D FIXED INPUT REGISTER)

	BIT 7	6	5	4	3	2	1	BIT 0	
S07	DDD7		DDD5	DDD4	DDD3	DDD2	DDD1	DDD0	
S1D	CR7	CR6	CR5	CR4	CR3	CR2	CR1	CR0	COPRR
S1E	R7	R6	R5	COPF	CME	COPE	CM1	CM0	COPCR
S3FDF	RAM0	RAM1					IRQ		OPTREG

(MC68HC05C9 ONLY)

	BIT 7	6	5	4	3	2	1	BIT 0	
S1C	0	0	0	0	0	LAT	0	PGM	PR
S1D	CR7	CR6	CR5	CR4	CR3	CR2	CR1	CR0	COPRR
S1E	0	0	0	COPF	CME	COPE	CM1	CM0	COPCR
S1F									UNUSED
S1FDF	RAM0	RAM1	0	0	SEC		IRQ	0	IRQOR

(MC68HC705C8 ONLY)

	BIT 7	6	5	4	3	2	1	BIT 0	
S1C	0	CPEN	0	0	ERASE	LATA	LATB	EPPGM	PR
S1D	A7	A6	A5	A4	A3	A2	A1	A0	ARL
S1E	0	0	MATCH	A12	A11	A10	A9	A8	ARH
S1F									UNUSED
S1FDF	0	0	0	0	0	0	IRQ	0	IRQOR

**For More Information On This Product,
Go to: www.freescale.com**

ACHR **Freescale Semiconductor, Inc.**

Alternate Counter High Register (ACHR) \$1A

7	6	5	4	3	2	1	0
ACH7	ACH6	ACH5	ACH4	ACH3	ACH2	ACH1	ACH0

RESET

1 1 1 1 1 0 1 1

ACLR

Alternate Counter Low Register (ACLR) \$1B

7	6	5	4	3	2	1	0
ACL7	ACL6	ACL5	ACL4	ACL3	ACL2	ACL1	ACL0

RESET

1 1 1 1 1 0 1 1

ARH

(MC68HC805C4 ONLY)

Hardware Breakpoint Register High (ARH) \$1E

7	6	5	4	3	2	1	0
0	0	MATCH	A12	A11	A10	A9	A8

RESET

0 0 0 0 0 0 0 0

MATCH — An instruction with the same address as that in the breakpoint register was fetched.

1 = Breakpoint enabled

0 = Breakpoint disabled

A12–A8 — Breakpoint address bits A12–A8

ARL

(MC68HC805C4 ONLY)

Hardware Breakpoint Register Low (ARL) \$1D

7	6	5	4	3	2	1	0
A7	A6	A5	A4	A3	A2	A1	A0

RESET

0 0 0 0 0 0 0 0

ARL

**For More Information On This Product,
Go to: www.freescale.com**

Baud Rate Register (BAUD) \$0D

The baud rate register is used to select the SCI transmitter and receiver baud rate. SCP0 and SCP1 prescaler bits are used in conjunction with the SCR2–SCR0 baud rates to provide multiple baud rate combinations for a given crystal frequency. Bits 3, 6, and 7 always read zero.

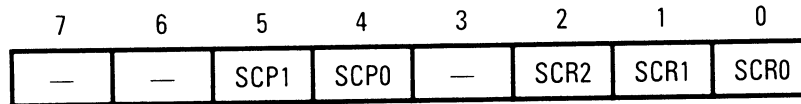

RESET	—	—	0	0	—	U	U	U
-------	---	---	---	---	---	---	---	---

SCP0 — SCI Prescaler Bit 0

SCP1 — SCI Prescaler Bit 1

Two prescaler bits are used to increase the range of standard baud rates controlled by the SCR2–SCR0 bits. Prescaler internal processor clock division versus bits levels are listed in Table 1.

SCR0 — SCI Baud Rate Bit 0

SCR1 — SCI Baud Rate Bit 1

SCR2 — SCI Baud Rate Bit 2

Three baud rate bits are used to select the baud rates of the SCI transmitter and SCI receiver. Baud rates versus bit levels are listed in Table 2.

Tables 1 and 2 tabulate the divide chain used to obtain the baud rate clock (transmit clock). The actual divider chain is controlled by the combined SCP1–SCP0 and SCR2–SCR0 bits in the baud rate register. All divided frequencies shown in Table 1 represent the final baud rate resulting from the internal processor clock division shown in the divided by column only (prescaler division only). Table 2 lists the prescaler output divided by the action of the SCI select bits (SCR2–SCR0). For example, assume that a 9600 Hz baud rate is required with a 2.4576 MHz external crystal. In this case, the prescaler bits (SCP1–SCP0) could be configured as a divided-by-two. Using the same crystal, the 9600 baud rate can be obtained with a prescaler divided-by-one and the SCR2–SCR0 bits configured for a divide-by-eight.

Table 1. Prescaler Highest Baud Rate Frequency Output

SCP Bit		Clock* Divided By	Crystal Frequency MHz					
			8.0	4.194304	4.0	2.4576	2.0	1.8432
0	0	1	250.00 kHz	131.072 kHz	125.000 kHz	76.80 kHz	62.60 kHz	57.60 kHz
0	1	3	83.332 kHz	43.691 kHz	41.666 kHz	25.60 kHz	20.833 kHz	19.20 kHz
1	0	4	62.500 kHz	32.768 kHz	31.250 kHz	19.20 kHz	15.625 kHz	14.40 kHz
1	1	13	19.200 kHz	10.082 kHz	9600 Hz	5.907 kHz	4800 Hz	4430 Hz

*Refers to the internal processor clock.

NOTE: The divided frequencies shown in Table 1 represent baud rates which are the highest transmit baud rate (Tx) that can be obtained by a specific crystal frequency and only using the prescaler division. Lower baud rates may be obtained by providing a further division using the SCI rate select bits as shown below for some representative prescaler outputs.

Table 2. Transmit Baud Rate Output for a Given Prescaler Output

SCR Bits		Divided By	Representative Highest Prescaler Baud Rate Output				
			131.072 kHz	32.768 kHz	76.80 kHz	19.20 kHz	9600 Hz
0	0	1	131.072 kHz	32.768 kHz	76.80 kHz	19.20 kHz	9600 Hz
0	0	2	65.536 kHz	16.384 kHz	38.40 kHz	9600 Hz	4800 Hz
0	1	4	32.768 kHz	8.192 kHz	19.20 kHz	4800 Hz	2400 Hz
0	1	8	16.384 kHz	4.096 kHz	9600 Hz	2400 Hz	1200 Hz
1	0	16	8.192 kHz	2.048 kHz	4800 Hz	1200 Hz	600 Hz
1	0	32	4.096 kHz	1.024 kHz	2400 Hz	600 Hz	300 Hz
1	1	64	2.048 kHz	512 Hz	1200 Hz	300 Hz	150 Hz
1	1	128	1.024 kHz	256 Hz	600 Hz	150 Hz	75 Hz

NOTE: Table 2 illustrates how the SCI select bits can be used to provide lower transmitter baud rate by further dividing the prescaler output frequency. The five examples are only representative samples. In all cases, the baud rates shown are transmit baud rates (transmit clock) and the receive clock is 16 times higher in frequency than the actual baud rate.

Counter High Register (CHR) \$18

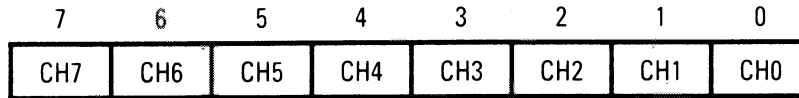

RESET

1 1 1 1 1 1 1 1

Counter Low Register (CLR) \$19

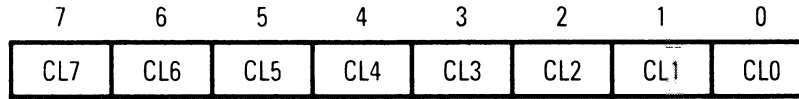

RESET

1 1 1 1 1 0 1 1



Freescale Semiconductor, Inc.**COPCR****(MC68HC705C8 ONLY)****COP Control Register (COPCR) \$1E**

The COPCR shown below is used to control the COP watchdog timer and clock monitor functions.

7	6	5	4	3	2	1	0
0	0	0	COPF	CME	COPE	CM1	CM0

RESET

0 0 0 0 0 0 0 0

COPF — Computer Operating Properly

1 = COP or clock monitor reset has occurred

0 = No COP or clock monitor reset has occurred

CME — Clock Monitor Enable

1 = Clock monitor enabled

0 = Clock monitor disabled

COPE — Computer Operating Properly Enable

1 = COP timeout enabled

0 = COP timeout disabled

CM1 — Computer Operating Properly Mode 1

Used in conjunction with CM0 to establish the COP timeout period. CM1 can be read and set anytime, but is cleared only by reset. See Table 3.

CM0 — Computer Operating Properly Mode 0

Used in conjunction with CM1 to establish the COP timeout period. CM0 can be read and set anytime, but is cleared only by reset. See Table 3.

Bits 7–5 — Not used*

Always read zero

*In the MC68HC05C9, these bits (R7–R5) are reserved factory test bits.

Table 3. COP Timeout Period

CM1	CM0	E/2 ¹⁵ Divided By	XTAL = 4.0 MHz, E = 2.0 MHz	XTAL = 3.5795 MHz, E = 1.7897 MHz	XTAL = 2.0 MHz, E = 1.0 MHz	XTAL = 1.0 MHz, E = 0.5 MHz
0	0	1	16.38 ms	18.31 ms	32.77 ms	65.54 ms
0	1	4	65.54 ms	73.24 ms	131.07 ms	262.14 ms
1	0	16	262.95 ms	292.95 ms	524.29 ms	1.048 s
1	1	64	1.048 s	1.172 s	2.097 s	4.194 s

(MC68HC705C8 AND MC68HC05C9 ONLY)



COPRR **Freescale Semiconductor, Inc.**

COP Reset Register (COPRR) \$1D

The COPRR shown below is used to control the COP watchdog timer and clock monitor functions.

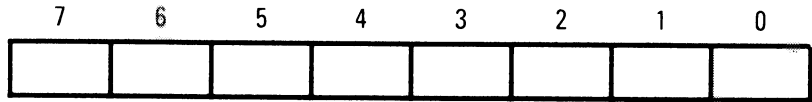

RESET
 0 0 0 0 0 0 0 0

The sequence required to reset the COP timer is as follows:

Write \$55 to the COP reset register.

Write \$AA to the COP reset register.

Both write operations must occur in the order listed, but any number of instructions may be executed between the two write operations. The elapsed time between software resets must not be greater than the COP timeout period. Reading the COP reset register does not return valid data and does not affect the watchdog timer.

(MC68HC705C8 AND MC68HC05C9 ONLY)

COP Reset Register (COPRR) \$1D

The COPRR shown below is used to control the COP watchdog timer and clock monitor functions.

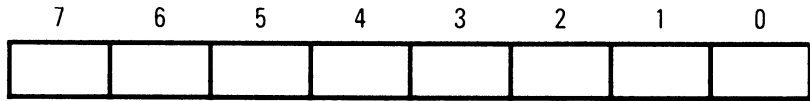

RESET
 0 0 0 0 0 0 0 0

The sequence required to reset the COP time is as follows:

Write \$55 to the COP reset register.

Write \$AA to the COP reset register.

Both write operations must occur in the order listed, but any number of instructions may be executed between the two write operations. The elapsed time between software resets must not be greater than the COP timeout period. Reading the COP reset register does not return valid data and does not affect the watchdog timer.

(MC68HC705C8 AND MC68HC05C9 ONLY)

Data Direction Register A (DDRA) \$04

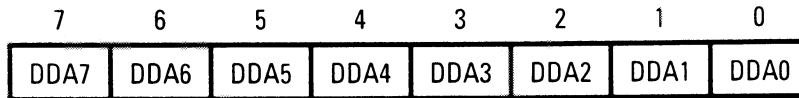

RESET
0 0 0 0 0 0 0 0

DDA7–DDA0 — 0 = Inputs
1 = Outputs

DDRB

Data Direction Register B (DDRB) \$05

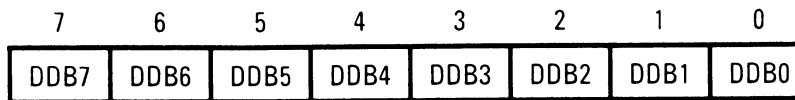

RESET
0 0 0 0 0 0 0 0

DDB7–DDB0 — 0 = Inputs
1 = Outputs

DDRC

Data Direction Register C (DDRC) \$06

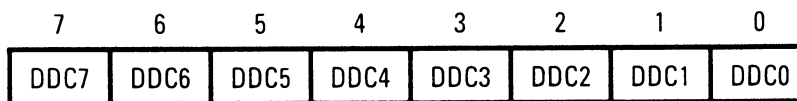

RESET
0 0 0 0 0 0 0 0

DDC7–DDC0 — 0 = Inputs
1 = Outputs

Freescale Semiconductor, Inc.

DDRD

Data Direction Register D (DDRD) \$07

7	6	5	4	3	2	1	0
DDD7	—	DDD5	DDD4	DDD3	DDD2	DDD1	DDD0

RESET

0 0 0 0 0 0 0 0

DDD5–DDD0 — 0 = Inputs
1 = Outputs

Bits 7,6 — Not used.

ICHR

Input Capture High Register (ICHR) \$14

7	6	5	4	3	2	1	0
ICH7	ICH6	ICH5	ICH4	ICH3	ICH2	ICH1	ICH0

RESET

U U U U U U U U

ICLR

Input Capture Low Register (ICLR) \$15

7	6	5	4	3	2	1	0
ICL7	ICL6	ICL5	ICL4	ICL3	ICL2	ICL1	ICL0

RESET

U U U U U U U U

ICLR

For More Information On This Product,
Go to: www.freescale.com

(MC68HC705C8 ONLY)

Option Register (IRQOR) \$1FDF

The option register is used to select the $\overline{\text{IRQ}}$ sensitivity, enable the PROM security, and select the memory configuration.

7	6	5	4	3	2	1	0
RAM0	RAM1	0	0	SEC	—	IRQ	0

RESET

0	0	0	0	U	—	1	0
---	---	---	---	---	---	---	---

RAM0—Random Access Memory Control Bit 0

1 = Maps 32 bytes of RAM into page zero starting at address \$0030. Addresses from \$0020 to \$0030 are reserved. This replaces 48 bytes of PROM that were used at these locations. This bit can be read or written at any time, allowing memory configuration to be changed during program execution.

0 = Provides 48 bytes of PROM at location \$0030.

RAM1—Random Access Memory Control Bit 1

1 = Maps 96 bytes of RAM into page zero starting at address \$0100. This replaces 96 bytes of PROM that were used at these locations. This bit can be read or written at any time, allowing memory configuration to be changed during program execution.

0 = Provides 96 bytes of PROM at location \$0100.

SEC—Security

1 = Bootloader disabled, MCU operates only in single-chip mode.

0 = Security off, bootloader enabled, expanded mode enabled.

IRQ—Interrupt Request Bit Sensitivity

1 = $\overline{\text{IRQ}}$ pin is both negative edge- and level-sensitive.

0 = $\overline{\text{IRQ}}$ pin is negative edge-sensitive only.

$\overline{\text{IRQ}}$ is set only by reset, but can be cleared by software.

This can only be written once.

Bit 0, 4, 5

Always read zero.

Bit 2

Can be either one or zero.

Freescale Semiconductor, Inc.

IRQOR

(MC68HC05C9 ONLY)

Option Register (IRQOR) \$3FDF

The option register is used to select the \overline{IRQ} sensitivity, enable the ROM security, and select the memory configuration.

7	6	5	4	3	2	1	0
RAM0	RAM1	0	0	0	0	IRQ	0

RESET

0	0	0	0	0	0	1	0
---	---	---	---	---	---	---	---

RAM0— Random Access Memory Control Bit 0

1 = Maps 32 bytes of RAM into page zero starting at address \$0020. This replaces 48 bytes of ROM that were used at these locations. This bit can be read or written at any time, allowing memory configuration to be changed during program execution.

0 = Provides 48 bytes of ROM at location \$0020.

RAM1— Random Access Memory Control Bit 1

1 = Maps 128 bytes of RAM into page zero starting at address \$0100. This replaces 128 bytes of ROM that were used at these locations. This bit can be read or written at any time, allowing memory configuration to be changed during program execution.

0 = Provides 128 bytes of ROM at location \$0100.

IRQ— Interrupt Request Bit Sensitivity

1 = \overline{IRQ} pin is both negative edge- and level-sensitive.

0 = \overline{IRQ} pin is negative edge-sensitive only.

\overline{IRQ} is set only by reset, but can be cleared by software.

This can only be written once.

Bit 0, 2, 3, 4, 5

Always read zero.

(MC68HC805C4 ONLY)

IRQ Option Register (IRQOR) \$1FDF

7	6	5	4	3	2	1	0
0	0	0	0	0	0	IRQ	0

RESET

0	0	0	0	0	0	1	0
---	---	---	---	---	---	---	---

Bits 7-2, 0 — Not used

Always read zero.

IRQ — Interrupt Request Bit Sensitivity

1 = $\overline{\text{IRQ}}$ pin is both negative edge- and level-sensitive.

0 = $\overline{\text{IRQ}}$ pin is negative edge-sensitive only.

IRQ is set only by reset, but can be cleared by software.

OCHR

Output Compare High Register (OCHR) \$16

7	6	5	4	3	2	1	0
OCH7	OCH6	OCH5	OCH4	OCH3	OCH2	OCH1	OCH0

RESET

U	U	U	U	U	U	U	U
---	---	---	---	---	---	---	---

OCLR

Output Compare Low Register (OCLR) \$17

7	6	5	4	3	2	1	0
OCL7	OCL6	OCL5	OCL4	OCL3	OCL2	OCL1	OCL0

RESET

U	U	U	U	U	U	U	U
---	---	---	---	---	---	---	---

Freescale Semiconductor, Inc.

PORTA

Port A Data Register (PORTA) \$00

7	6	5	4	3	2	1	0
PA7	PA6	PA5	PA4	PA3	PA2	PA1	PA0

RESET
U U U U U U U U

PORTB

Port B Data Register (PORTB) \$01

7	6	5	4	3	2	1	0
PB7	PB6	PB5	PB4	PB3	PB2	PB1	PB0

RESET
U U U U U U U U

PORTC

Port C Data Register (PORTC) \$02

7	6	5	4	3	2	1	0
PC7	PC6	PC5	PC4	PC3	PC2	PC1	PC0

RESET
U U U U U U U U

PORTD

Port D Data Register (PORTD) \$03

7	6	5	4	3	2	1	0
PD7		PD5	PD4	PD3	PD2	PD1	PD0

RESET
PD7 0 PD5/
SS PD4/
SCK PD3/
MOSI PD2/
MISO PD1/
TDO PD0/
RDI

(Port D fixed input register)

RESET
U U U U U U U U

PORTD

**For More Information On This Product,
Go to: www.freescale.com**

(MC68HC705C8 ONLY)

Program Register (PR) \$1C

The program register (\$1C) is used to perform PROM programming.

7	6	5	4	3	2	1	0
0	0	0	0	0	LAT	0	PGM

RESET

0	0	0	0	0	0	0	0
---	---	---	---	---	---	---	---

LAT — Latch Enable

1 = Enables PROM data and address bus latches for programming or erasing on the next byte write cycle.

0 = Latch disabled. PROM data and address buses are unlatched for normal CPU operations.

This bit is both readable and writable.

PGM — Program

1 = Applies V_{pp} power to the PROM for programming.

0 = V_{pp} power off.

If LAT is cleared, PGM cannot be set.

Bits 1, 7-3 — Not Used

Always read zero.

(MC68HC805C4 ONLY)

Program Register (PR) \$1C

The program register (\$1C) is used for single-byte EEPROM programming.

7	6	5	4	3	2	1	0
0	CPEN	0	0	ERASE	LATA	LATB	EEPGM

RESET

0	0	0	0	0	0	0	0
---	---	---	---	---	---	---	---

CPEN — Charge Pump Enable

1 = Charge pump enabled

0 = Charge pump disabled

ERASE — Erase EEPROM Enable

1 = Erase enabled

0 = Erase disabled

LATA — Latch A Enable

1 = Enables array A data and address bus latches for programming or erasing on the next byte write cycle.

0 = Latch disabled

LATB — Latch B Enable

1 = Enables array B data and address bus latches for programming or erasing on the next byte write cycle.

0 = Latch disabled

Note: If LATA and LATB are cleared, EEGM cannot be set.

PR Freescale Semiconductor, Inc.

EEPROM — Electrically Erase/Program

1 = Applies V_{pp} power to the EEPROM array for programming or erasing operation.

0 = V_{pp} power off

Bits 4, 5, 7 — Not used

Always read zero.

SCCR1

Serial Communications Control Reg. 1 (SCCR1) \$0E

The SCCR1 register control bits determine word length and select the wake-up method.

7	6	5	4	3	2	1	0
R8	T8	—	M	WAKE	—	—	—

RESET

U U — U U — — —

R8 — Receive Data Bit 8

R8 bit provides storage location for the ninth bit in the receive data byte (if M = 1).

T8 — Transmit Data Bit 8

T8 bit provides storage location for the ninth bit in the transmit data byte (if M = 1).

M — SCI Character Word Length

1 = One start bit, nine data bits, one stop bit

0 = One start bit, eight data bits, one stop bit

WAKE — Wake-Up Select

Wake bit selects the receiver wake-up method.

1 = Address bit (most significant bit)

0 = Idle line condition

Bits 2–0 and 5 — Not used

Can read either one or zero.

The address bit is dependent on both the wake-bit and the m-bit level. Additionally, the receiver does not use the wake-up feature unless the RWU control bit in SCCR2 is set.

Wake	M	Receiver Wake-Up
0	X	Detection of an idle line allows the next data byte received to cause the receive data register to fill and produce an RDRF flag.
1	0	Detection of a received one in the eighth data bit allows an RDRF flag and associated error flags.
1	1	Detection of a received one in the ninth data bit allows an RDRF flag and associated error flags.

SCCR1

For More Information On This Product,
Go to: www.freescale.com

Serial Communications Control Reg. 2 (SCCR2) \$0F

The SCCR2 provides control of individual SCI functions such as interrupts, transmit/receive enabling, receiver wakeup, and break code.

7	6	5	4	3	2	1	0
TIE	TCIE	RIE	ILIE	TE	RE	RWU	SBK

RESET

0 0 0 0 0 0 0 0

TIE — Transmit Interrupt Enable

1 = SCI interrupt enabled

0 = TDRE interrupt disabled

TCIE — Transmit Complete Interrupt Enable

1 = SCI interrupt enabled

0 = TC interrupt disabled

RIE — Receive Interrupt Enable

1 = SCI interrupt enabled

0 = RDRF and OR interrupts disabled

ILIE — Idle Line Interrupt Enable

1 = SCI interrupt enabled

0 = Idle interrupt disabled

TE — Transmit Enable

1 = Transmit shift register output is applied to the TDO line. Depending upon the SCCR1 M bit, a preamble of 10 (M = 0) or 11 (M = 1) consecutive ones is transmitted.

0 = Transmitter disabled after last byte is loaded in the SCDAT and TDRE is set. After last byte is transmitted, TDO line becomes a high-impedance line.

RE — Receive Enable

1 = Receiver shift register input is applied to the RDI line.

0 = Receiver disabled and RDRF, IDLE, OR, NF, and FE status bits are inhibited.

SCCR2 **Freescale Semiconductor, Inc.**

RWU — Receiver Wake-Up

1 = Places receiver in sleep mode and enables wake-up function.

0 = Wake-up function disabled after receiving data word with MSB set (if WAKE = 1). Wake-up function also disabled after receiving 10 (M = 0) or 11 (M = 1) consecutive ones (if WAKE = 0).

SBK — Send Break

1 = Transmitter continually sends blocks of zeros (sets of 10 or 11) until cleared. Upon completion of break code, transmitter sends one high bit for recognition of valid start bit.

0 = Transmitter sends 10 (M = 0) or 11 (M = 1) zeros then reverts to an idle state or continues sending data. If transmitter is empty and idle, setting and clearing the SBK bit may queue up to two character times of break because the first break transfer immediately to the shift register, and the second is queued into the parallel transmit buffer.

SCDAT

Serial Communications Data Register (SCDAT) \$11

The SCDAT is a read/write register used to receive and transmit SCI data.

7	6	5	4	3	2	1	0
SCD7	SCD6	SCD5	SCD4	SCD3	SCD2	SCD1	SCD0

RESET

U U U U U U U U

SCSR

Serial Communications Status Register (SCSR) \$10

The SCSR provides inputs to the SCI interrupt logic circuits. Noise flag and framing error bits are also contained in the SCSR.

7	6	5	4	3	2	1	0
TDRE	TC6	RDRF	IDLE	OR	NF	FE	—

RESET

1 1 0 0 0 0 0 —

TDRE — Transmit Data Register (TDR) Empty

0 = TDR contents transferred to the transmit data shift register.

0 = TDR still contains data. TDRE is cleared by reading the SCSR followed by a write to the TDR.

SCSR

**For More Information On This Product,
Go to: www.freescale.com**

TC — Transmit Complete

- 1 = Indicates end of data frame, preamble, or break condition has occurred.
- 0 = TC bit cleared by reading the SCSR, followed by a write to the TDR.

RDRF — Receive Data Register (RDR) Full

- 1 = Receive data shift register contents transferred to the RDR.
- 0 = Receive data shift register transfer did not occur. RDRF is cleared by reading the SCSR, followed by a read of the RDR.

IDLE — Idle Line Detect

- 1 = Indicates receiver has detected an idle line.
- 0 = IDLE is cleared by reading the SCSR, followed by a read of the RDR. Once IDLE is cleared, IDLE cannot be set until RDI line becomes active and idle again.

OR — Overrun Error

- 1 = Indicates receive data shift register data is sent to a full RDR (RDRF = 1). Data causing the overrun is lost, and RDR data is not disturbed.
- 0 = OR is cleared by reading the SCSR, followed by a read of the RDR.

NF — Noise Flag

- 1 = Indicates noise is present on the receive bits, including the start and stop bits. NF is not set until RDRF = 1.
- 0 = NF is cleared by reading the SCSR, followed by a read of the RDR.

FE — Framing Error

- 1 = Indicates stop bit not detected in received data character. FE is set the same time RDRF is set. If received byte causes both framing and overrun errors, processor will only recognize the overrun error. Further data transfer into the RDR is inhibited until FE is cleared.
- 0 = FE is cleared by reading the SCSR, followed by a read of the RDR.

Bit 0 — Not used

- Can read either one or zero.

SPCR **Freescale Semiconductor, Inc.**

Serial Peripheral Control Register (SPCR) \$0A

The SPCR provides control of individual SPI functions such as interrupt and system enabling/disabling, master/slave mode select, and clock polarity/phase rate select.

7	6	5	4	3	2	1	0
SPIE	SPE	DWOM*	MSTR	CPOL	CPHA	SPR1	SPR0

RESET

0 0 — 0 U U U U

SPIE — Serial Peripheral Interrupt Enable

1 = SPI interrupt enabled

0 = SPI interrupt disabled

SPE — Serial Peripheral System Enable

1 = SPI system on

0 = SPI system off

MSTR — Master Mode Select

1 = Master mode

0 = Slave mode

CPOL — Clock Polarity

Clock polarity bit controls the clock value and is used in conjunction with the clock phase (CPHA) bit.

1 = SCK line idles high

0 = SCK line idles in low state

CPHA — Clock Phase

Clock phase bit along with CPOL controls the clock-data relationship between the master and slave devices. CPOL selects one or two clocking protocols.

1 = \overline{SS} is an output enable control.

0 = Shift clock is the OR or SCK with \overline{SS} .

When \overline{SS} is low, first edge of SCK invokes first data sample.

SPR1-SPR0 — SPI Clock Rate Bits

Two clock rate bits are used to select one of four clock rates to be used as SCK in the master mode. In the slave mode, the two clock rate bits have no effect. Clock rate selection is shown in the following table.

SPR1	SPR0	Internal Processor Clock Divided By
0	0	2
0	1	4
1	0	16
1	1	32

Bit 5 — Not used*

Can read either one or zero.

(*MC68HC05C9 only, bit 5 (DWOM) is the wire-OR mode bit.)

1 = Disables active pullup devices on Port D, causing outputs to be open drain.

0 = Open-drain disabled.

SPCR

**For More Information On This Product,
Go to: www.freescale.com**

Serial Peripheral Data I/O Register (SPDR) \$0C

The SPDR is read/write register used to receive and transmit SPI data.

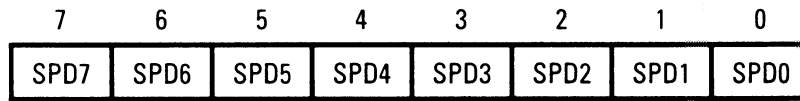

A write to the SPDR places data directly into the shift register for transmission. Only a write to this register will initiate transmission/reception of another byte and will only occur in the master device. On completion of byte transmission, the SPIF status bit is set in both master and slave devices.

A read to the SPDR causes the buffer to be read. The first SPIF status bit must be cleared by the time a second data transfer from the shift register to the read buffer begins, or an overrun condition will exist. In overrun cases, the byte causing the overrun is lost.

SPSR

Serial Peripheral Status Register (SPSR) \$0B

The SPSR contains three status bits.

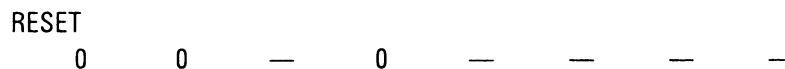
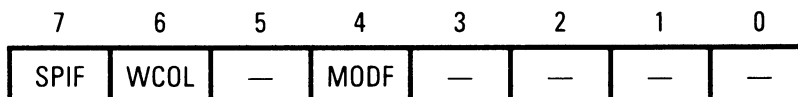

SPIF — Serial Peripheral Data Transfer Flag

1 = Indicates data transfer completed between processor and external device.

(If SPIF = 1 and SPIE = 1, SPI interrupt is enabled.)

0 = Clearing is accomplished by reading SPSR, followed by SPDR access.

WCOL — Write Collision

1 = Indicates an attempt is made to write to SPDR while data transfer is in processor.

0 = Clearing is accomplished by reading SPSR, followed by SPDR access.

MODF — Mode Fault Flag

1 = Indicates multi-master system control conflict.

0 = Clearing is accomplished by reading SPSR, followed by a write to the SPCR.

Bits 3–0 and 5 — Not used

Can read either zero or one.

Timer Control Register (TCR) \$12

The TCR is a read/write register containing five control bits. Three bits control interrupts associated with the timer status register flags ICF, OCF, and TOF.

7	6	5	4	3	2	1	0
ICIE	OCIE	TOIE	0	0	0	IEDG	OLVL

RESET

0 0 0 0 0 0 U 0

ICIE — Input Capture Interrupt Enable

1 = Interrupt enabled

0 = Interrupt disabled

OCIE — Output Compare Interrupt Enable

1 = Interrupt enabled

0 = Interrupt disabled

TOIE — Timer Overflow Interrupt Enable

1 = Interrupt enabled

0 = Interrupt disabled

IEDG — Input Edge

Value of input edge determines which level transition on TCAP pin will trigger free-running counter transfer to the input capture register.

1 = Positive edge

0 = Negative edge

OLVL — Output Level

Value of output level is clocked into output level register by the next successful output compare and will appear on the TCMP pin.

1 = High output

0 = Low output

Bits 2, 3, and 4 — Not used

Always read zero.

Timer Status Register (TSR) \$13

The TSR is a read-only register containing three status flag bits.

7	6	5	4	3	2	1	0
ICF	OCF	TOF	0	0	0	0	0

RESET
 U U U 0 0 0 0 0

ICF — Input Capture Flag

1 = Flag set when selected polarity edge is sensed by input capture edge detector.

0 = Flag cleared when TSR and input capture low register (\$15) are accessed.

OCF — Output Compare Flag

1 = Flag set when output compare register contents match the free-running counter contents.

0 = Flag cleared when TSR and output compare low register (\$17) are accessed.

TOF — Timer Overflow Flag

1 = Flag set when free-running counter transition from \$FFFF to \$0000 occurs.

0 = Flag cleared when TSR and counter low register (\$19) are accessed.

Bits 4–0 — Not used

Always read zero.



Freescale Semiconductor, Inc.

ADDRESSING MODES

IMMEDIATE (IMM)

The effective address (EA) of an immediate mode instruction is the location following the opcode. This mode is used to fetch a value which is known at the time the program is written, and which is not changed during program execution.

DIRECT (DIR)

The EA of a direct mode instruction is the contents of the byte following the opcode. This mode is used to fetch a value from any one of the first 256 memory locations with a two-byte instruction.

EXTENDED (EXT)

The EA of an extended mode instruction is the contents of the next two bytes following the opcode. This mode is used to fetch a value from any location in the MC146805G2 memory location, I/O, RAM, and ROM, with a three-byte instruction.

INDEXED (IX, IX1, IX2)

The EA of an indexed mode instruction is determined by the contents of the X-register being added to an offset. The offset can be either zero, 8-bit, or 16-bit. For zero offset (IX), the X-register is the EA. For 8-bit offset (IX1), the result of the X-register contents added to the byte following the opcode is the EA. For 16-bit offset (IX2), the result of the X-register contents added to the concatenated contents of the two bytes following the opcode is the EA.

RELATIVE (REL)

The EA of a relative mode instruction depends upon whether or not the branch is taken. If a branch is taken, EA is formed by adding the byte following the opcode to the value of the program counter, and the program counter is loaded with the EA. If no branch is required, EA is equal to the contents of the program counter.

BIT SET/CLEAR (BSC)

The EA of a Bit Set/Clear mode instruction is contained in the byte following the opcode. The actual bit which is to be set or cleared is contained in the lower four bits (nibble) of the opcode.

BIT TEST AND BRANCH (BTB)

This addressing mode combines direct, relative and bit addressing. The EA of this instruction is the contents of the byte following the opcode (direct mode), if no branch is taken. If a branch is taken, the EA becomes the result of the second byte following the opcode being added to the value of the program counter (similar to relative mode). The actual bit which is to be tested is contained in the lower four bits (nibble) of the opcode.

INHERENT (INH)

This addressing mode has no EA since all information necessary to carry out the instruction is contained in the opcode.

**For More Information On This Product,
Go to: www.freescale.com**

Freescale Semiconductor, Inc. M68HC05 INSTRUCTION SET

The following table is an alphabetical listing of the instructions available to the M68HC05 MCU user. In listing all the factors necessary to program, the table uses the following symbols:

Condition Code Symbols

H — Half Carry (Bit 4)	↕ — Test and Set if True, (Cleared otherwise)
I — Interrupt Mask (Bit 3)	— — Not Affected
N — Negate (Sign Bit 2)	? — Load CC Reg. from Stack
Z — Zero (Bit 1)	0 — Cleared
C — Carry/Borrow (Bit 0)	1 — Set

Boolean Operators

() — Contents of (i.e.) (M) = means the contents of memory location M	+ — (inclusive) OR
◆ — is loaded with, 'gets'	⊕ — EXCLUSIVE OR
• — AND	— — NOT
	- — negation (twos complement)
	× — multiplication

MPU Registers

A — Accumulator	PC — Program Counter
ACCA — Accumulator	PCH — PC High Byte
CC — Condition Code Reg.	PCL — PC Low Byte
X — Index Register	SP — Stack Pointer
M — Any memory location (one byte)	REL — Relative Address

Addressing Modes

(Abbreviation)

Operands

Inherent	INH	none
Immediate	IMM	ii
Direct (for bit test instructions)	DIR	dd rr
Extended	EXT	hh ll
Indexed 0 Offset	IX	none
Indexed 1-Byte	IX1	ff
Indexed 2-Byte	IX2	ee ff
Relative	REL	rr

INSTRUCTIONS, ADDRESSING MODES, AND EXECUTION TIMES

Source Form(s)	Operation	Boolean Expression	Addressing Mode for Operand	Machine Coding (hexadecimal)		Bytes	Cycles	Condition Code				
				Opcode	Operand			H	I	N	Z	C
ADC (opr)	Add with Carry	ACCA \blacktriangleleft ACCA + M + C	IMM DIR EXT IX2 IX1 IX	A9	ii	2	2	\blacktriangleleft	—	\blacktriangleleft	\blacktriangleleft	\blacktriangleleft
				B9	dd	2						
				C9	hh ll	3						
				D9	ee ff	3						
				E9	ff	2						
				F9		1						
ADD (opr)	Add	ACCA \blacktriangleleft ACCA + M	IMM DIR EXT IX2 IX1 IX	AB	ii	2	2	\blacktriangleleft	—	\blacktriangleleft	\blacktriangleleft	\blacktriangleleft
				BB	dd	2						
				CB	hh ll	3						
				DB	ee ff	3						
				EB	ff	2						
				FB		1						
AND (opr)	Logical AND	ACCA \blacktriangleleft ACCA • M	IMM DIR EXT IX2 IX1 IX	A4	ii	2	2	—	—	\blacktriangleleft	\blacktriangleleft	—
				B4	dd	2						
				C4	hh ll	3						
				D4	ee ff	3						
				E4	ff	2						
				F4		1						

ASL (opr)	Arithmetic Shift Left		DIR INH(A) INH(X) IX1 IX	38 48 58 68 78	dd ff	2 1 1 2 1	5 3 3 6 5	— —	— —	— —	— —	
ASLA ASLX ASL (opr) ASL (opr)												
ASR (opr) ASRA ASRX ASR (opr) ASR (opr)	Arithmetic Shift Right		DIR INH(A) INH(X) IX1 IX	37 47 57 67 77	dd ff	2 1 1 2 1	5 3 3 6 5	— —	— —	— —	— —	
CC (rel)	Branch if Carry Clear	? C = 0	REL	24	rr	2	3	—	—	—	—	—
CLR n, (opr)	Clear Bit n in Memory	Mn 0	DIR(b0) DIR(b1) DIR(b2) DIR(b3) DIR(b4) DIR(b5) DIR(b6) DIR(b7)	11 13 15 17 19 1B 1D 1F	dd dd dd dd dd dd dd dd	2 2 2 2 2 2 2 2	5 5 5 5 5 5 5 5	— —	— —	— —	— —	
BCS (rel)	Branch if Carry Set	? C = 1	REL	25	rr	2	3	—	—	—	—	—
BEO (rel)	Branch if Equal	? Z = 1	REL	27	rr	2	3	—	—	—	—	—

For More Information On This Product, Go to: www.freescale.com



Source Form(s)	Operation	Boolean Expression	Addressing Mode for Operand	Machine Coding (hexadecimal)		Bytes	Cycles	Condition Code					
				Opcode	Operand			H	I	N	Z	C	
BHCC (rel)	Branch if Half Carry Clear	? H = 0	REL	28	rr	2	3	—	—	—	—	—	—
BHCS (rel)	Branch if Half Carry Set	? H = 1	REL	29	rr	2	3	—	—	—	—	—	—
BHHL (rel)	Branch if Higher	? (C + Z) = 0	REL	22	rr	2	3	—	—	—	—	—	—
BHHS (rel)	Branch if Higher or Same	? C = 0	REL	24	rr	2	3	—	—	—	—	—	—
BHHH (rel)	Branch if \overline{IRQ} Pin is High	? \overline{IRQ} Pin = 1	REL	2F	rr	2	3	—	—	—	—	—	—
BHLL (rel)	Branch if \overline{IRQ} Pin is Low	? \overline{IRQ} Pin = 0	REL	2E	rr	2	3	—	—	—	—	—	—
BHIT (rel)	Bit Test Memory with A	ACCA • M	IMM DIR EXT IX2 IX1 IX	A5 B5 C5 D5 E5 F5	ii dd hh ll ee ff	2 2 3 3 2 1	2 3 4 5 4 3	—	—	—	—	—	—
BHLO (rel)	Branch if Lower	? C = 1	REL	25	rr	2	3	—	—	—	—	—	—
BHLS (rel)	Branch if Lower or Same	? (C + X) = 1	REL	23	rr	2	3	—	—	—	—	—	—
BHMC (rel)	Branch if I Bit is Clear	? I = 0	REL	2C	rr	2	3	—	—	—	—	—	—

BMI (rel)	Branch if Minus	? N = 1	REL	2B	rr	2	3	—	—	—	—	—	
BMS (rel)	Branch if I Bit is Set	? I = 1	REL	2D	rr	2	3	—	—	—	—	—	
BNE (rel)	Branch if Not Equal	? Z = 0	REL	26	rr	2	3	—	—	—	—	—	
BPL (rel)	Branch if Plus	? N = 0	REL	2A	rr	2	3	—	—	—	—	—	
BRA (rel)	Branch Always	? 1 = 1	REL	20	rr	2	3	—	—	—	—	—	
BRCLR n, (opr) (rel)	Branch if Bit n of M = 0	? Bit n of M = 0	DIR(b0)	01	dd	rr	3	5	—	—	—	—	↔
			DIR(b1)	03	dd	rr	3	5	—	—	—	—	—
			DIR(b2)	05	dd	rr	3	5	—	—	—	—	—
			DIR(b3)	07	dd	rr	3	5	—	—	—	—	—
			DIR(b4)	09	dd	rr	3	5	—	—	—	—	—
			DIR(b5)	0B	dd	rr	3	5	—	—	—	—	—
			DIR(b6)	0D	dd	rr	3	5	—	—	—	—	—
			DIR(b7)	0F	dd	rr	3	5	—	—	—	—	—
BRN (rel)	Branch Never	? 1 = 0	REL	21	rr	2	3	—	—	—	—	—	
BRSET n, (opr) (rel)	Branch if Bit n of M = 1	? Bit n of M = 1	DIR(b0)	00	dd	rr	3	5	—	—	—	—	↔
			DIR(b1)	02	dd	rr	3	5	—	—	—	—	—
			DIR(b2)	04	dd	rr	3	5	—	—	—	—	—
			DIR(b3)	06	dd	rr	3	5	—	—	—	—	—
			DIR(b4)	08	dd	rr	3	5	—	—	—	—	—
			DIR(b5)	0A	dd	rr	3	5	—	—	—	—	—
			DIR(b6)	0C	dd	rr	3	5	—	—	—	—	—
DIR(b7)	0E	dd	rr	3	5	—	—	—	—	—			



Source Form(s)	Operation	Boolean Expression	Addressing Mode for Operand	Machine Coding (hexadecimal)		Bytes	Cycles	Condition Code				
				Opcode	Operand			H	I	N	Z	C
BSET n, (opr)	Set Bit n in Memory	Mn \leftarrow 1	DIR(b0) DIR(b1) DIR(b2) DIR(b3) DIR(b4) DIR(b5) DIR(b6) DIR(b7)	10	dd	2	5	—	—	—	—	—
				12	dd	2	5	—	—	—	—	—
				14	dd	2	5	—	—	—	—	—
				16	dd	2	5	—	—	—	—	—
				18	dd	2	5	—	—	—	—	—
				1A	dd	2	5	—	—	—	—	—
				1C	dd	2	5	—	—	—	—	—
				1E	dd	2	5	—	—	—	—	—
BSR (rel)	Branch to Subroutine	PC \leftarrow PC+0002 (SP) \leftarrow PCL; SP \leftarrow SP-0001 (SP) \leftarrow PCH; SP \leftarrow SP-0001 PC \leftarrow PC+Rel	REL	AD	rr	2	6	—	—	—	—	
CLC	Clear C Bit	C bit \leftarrow 0	INH	98		1	2	—	—	—	0	
CLI	Clear I Bit	I bit \leftarrow 0	INH	9A		1	2	—	—	—	—	
CLR (opr) CLRA CLR X CLR (opr) CLR (opr)	Clear	M \leftarrow 00 A \leftarrow 00 X \leftarrow 00 M \leftarrow 00 M \leftarrow 00	DIR INH(A) INH(X) IX1 IX	3F	dd	2	5	—	—	0	1	—
				4F		1	3	—	—	—	—	—
				5F		1	3	—	—	—	—	—
				6F	ff	2	6	—	—	—	—	—
				7F		1	5	—	—	—	—	—

CMP (opr)	Compare A with Memory	ACCA—M	IMM	A1 B1 C1 D1 E1 F1	ii dd hh ee ff	2 2 3 3 2 1	2 3 4 5 4 3	— —	— —	— —	— —
COM (opr)	1's Complement	M ← M = \$FF - M A ← A = \$FF - A X ← X = \$FF - X M ← M = \$FF - M M ← M = \$FF - M	DIR INH(A) INH(X) IX1 IX	33 43 53 63 73	dd ff	2 1 1 2 1	5 3 3 6 5	— —	— —	— —	— —
CPX (opr)	Compare X with Memory	X—M	IMM DIR EXT IX2 IX1 IX	A3 B3 C3 D3 E3 F3	ii dd hh ee ff	2 2 3 3 2 1	2 3 4 5 4 3	— —	— —	— —	— —
DEC (opr) DECA DECX DEC (opr) DEC (opr)	Decrement DEX (same as DECX)	M ← M - 01 A ← A - 01 X ← X - 01 M ← M - 01 M ← M - 01	DIR INH(A) INH(X) IX1 IX	3A 4A 5A 6A 7A	dd ff	2 1 1 2 1	5 3 3 6 5	— —	— —	— —	— —



Source Form(s)	Operation	Boolean Expression	Addressing Mode for Operand	Machine Coding (hexadecimal)		Bytes	Cycles	Condition Code				
				Opcode	Operand			H	I	N	Z	C
EOR (opr)	Exclusive OR A with Memory	$ACCA \leftarrow ACCA \oplus M$	IM ¹ M DIR EXT IX2 IX1 IX	A8	ii	2	2	—	—	—	—	—
				B8	dd	2	3	—	—	—	—	—
				C8	hh	3	4	—	—	—	—	—
				D8	ee	3	5	—	—	—	—	—
				E8	ff	2	4	—	—	—	—	—
				F8		1	3	—	—	—	—	—
INC (opr) INCA INCX INC (opr) INC (opr)	Increment INX (same as INCX)	$M \leftarrow M + 01$ $A \leftarrow A + 01$ $X \leftarrow X + 01$ $M \leftarrow M + 01$ $M \leftarrow M + 01$	DIR INH(A) INH(X) IX1 IX	3C	dd	2	5	—	—	—	—	
				4C		1	3	—	—	—	—	
				5C		1	3	—	—	—	—	
				6C	ff	2	6	—	—	—	—	
				7C		1	5	—	—	—	—	
JMP (opr)	Jump	PC \leftarrow effective address	DIR EXT IX2 IX1 IX	BC	dd	2	2	—	—	—	—	
				CC	hh	3	3	—	—	—	—	
				DC	ee	3	4	—	—	—	—	
				EC	ff	2	3	—	—	—	—	
				FC		1	2	—	—	—	—	
JSR (opr)	Jump to Subroutine	$PC \leftarrow PC + n$ (n = 1, 2, or 3) $(SP) \leftarrow PCL; SP \leftarrow SP - 0001$ $(SP) \leftarrow PCH; SP \leftarrow SP - 0001$ $PC \leftarrow$ effective address	DIR EXT IX2 IX1 IX	BD	dd	2	5	—	—	—	—	
				CD	hh	3	6	—	—	—	—	
				DD	ee	3	7	—	—	—	—	
				ED	ff	2	6	—	—	—	—	
				FD		1	5	—	—	—	—	

Freescale Semiconductor, Inc.

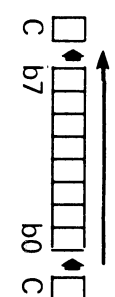
Source Form(s)	Operation	Boolean Expression	Addressing Mode for Operand	Machine Coding (hexadecimal)		Bytes	Cycles	Condition Code				
				Opcode	Operand			H	I	N	Z	C
NEG (opr) NEGA NEGX NEG (opr) NEG (opr)	Negates (2's Complement)	M \blacklozenge \neg M (i.e. 00 \neg M) A \blacklozenge \neg A X \blacklozenge \neg X M \blacklozenge \neg M M \blacklozenge \neg M	DIR INH(A) INH(X) IX1 IX	30 40 50 60 70	dd ff	2 1 1 2 1	5 3 3 6 5	— — — — —	— — — — —	\blacklozenge \blacklozenge \blacklozenge \blacklozenge \blacklozenge	\blacklozenge \blacklozenge \blacklozenge \blacklozenge \blacklozenge	\blacklozenge \blacklozenge \blacklozenge \blacklozenge \blacklozenge
NOP	No Operation		INH	9D		1	2	— — —	— — —	\blacklozenge \blacklozenge \blacklozenge	\blacklozenge \blacklozenge \blacklozenge	\blacklozenge \blacklozenge \blacklozenge
ORA (opr)	Inclusive OR	ACCA \blacklozenge ACCA + M	IMM DIR EXT IX2 IX1 IX	AA BA CA DA EA FA	ii dd hh ll ff	2 2 3 3 2 1	2 3 4 5 4 3	— — — — — —	— — — — — —	\blacklozenge \blacklozenge \blacklozenge \blacklozenge \blacklozenge \blacklozenge	\blacklozenge \blacklozenge \blacklozenge \blacklozenge \blacklozenge \blacklozenge	\blacklozenge \blacklozenge \blacklozenge \blacklozenge \blacklozenge \blacklozenge
ROL (opr) ROLA ROLX ROL (opr) ROL (opr)	Rotate Left through Carry		DIR INH(A) INH(X) IX1 IX	39 49 59 69 79	dd ff	2 1 1 2 1	5 3 3 6 5	— — — — —	— — — — —	\blacklozenge \blacklozenge \blacklozenge \blacklozenge \blacklozenge	\blacklozenge \blacklozenge \blacklozenge \blacklozenge \blacklozenge	\blacklozenge \blacklozenge \blacklozenge \blacklozenge \blacklozenge

For More Information On This Product, Go to: www.freescale.com

Freescale Semiconductor, Inc.

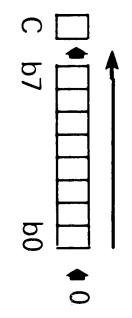
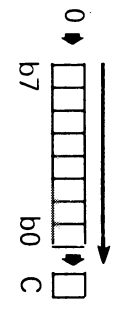
LDA (opr)	Load A from Memory	ACCA \blacklozenge M	IMM DIR EXT IX2 IX1 IX	A6 B6 C6 D6 E6 F6	ii dd hh ff ff	2 2 3 3 2 1	2 3 4 5 4 3	— — — — — —	\blacklozenge	\blacklozenge	—
LDX (opr)	Load X from Memory	X \blacklozenge M	IMM DIR EXT IX2 IX1 IX	AE BE CE DE EE FE	ii dd hh ee ff	2 2 3 3 2 1	2 3 4 5 4 3	— — — — — —	\blacklozenge	\blacklozenge	—
LSL (opr) LSLA LSLX LSL (opr) LSL (opr)	Logical Shift Left		DIR INH(A) INH(X) IX1 IX	38 48 58 68 78	dd ff	2 1 1 2 1	5 3 3 6 5	— — — — —	\blacklozenge	\blacklozenge	—
LSR (opr) LSRA LSRX LSR (opr) LSR (opr)	Logical Shift Right		DIR INH(A) INH(X) IX1 IX	34 44 54 64 74	dd ff	2 1 1 2 1	5 3 3 6 5	— — — — —	0	\blacklozenge	—
MUL	Unsigned Multiply	X:A \blacklozenge X•A	INH	42		1	11	0	—	—	0

For More Information On This Product,
Go to: www.freescale.com

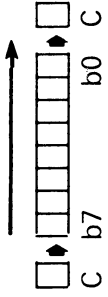

ROR (opr)	Rotate Right through Carry		DIR INH(A) INH(X) IX1 IX	36 46 56 66 76	dd ff	2 1 1 2 1	5 3 3 6 5	— — — — —	— — — — —	— — — — —	— — — — —
MSP	Reset Stack Pointer	SP ← \$00FF	INH	9C		1	2	—	—	—	—
RTI	Return from Interrupt	SP ← SP + 0001; CC ← (SP) SP ← SP + 0001; ACCA ← (SP) SP ← SP + 0001; X ← (SP) SP ← SP + 0001; PCH ← (SP) SP ← SP + 0001; PCL ← (SP)	INH	80		1	9	(Loaded from Stack)			
RTS	Return from Subroutine	SP ← SP + 0001; PCH ← (SP) SP ← SP + 0001; PCL ← (SP)	INH	81		1	6	—	—	—	—
ABC (opr)	Subtract with Carry	ACCA ← ACCA - M - C	IMM DIR EXT IX2 IX1 IX	A2 B2 C2 D2 E2 F2	ii dd hh ee ff	2 2 3 3 2 1	2 3 4 5 4 3	— — — — — —	— — — — — —	— — — — — —	— — — — — —
SEC	Set C Bit	C bit ← 1	INH	99		1	2	—	—	—	1
SEI	Set I Bit	I bit ← 1	INH	9B		1	2	—	—	—	—





Source Form(s)	Operation	Boolean Expression	Addressing Mode for Operand	Machine Coding (hexadecimal)		Bytes	Cycles	Condition Code				
				Opcode	Operand			H	I	N	Z	C
STA (opr)	Store A in Memory	M \leftarrow ACCA	DIR EXT IX2 IX1 IX	B7	dd	2	4	—	—	—	—	—
				C7	hh ll	3		—	—	—	—	
				D7	ee ff	3		—	—	—	—	
				E7	ff	2		—	—	—	—	
				F7		1		—	—	—	—	
STOP	Enable $\overline{\text{IRQ}}$, Stop Oscillator		INH	8E		1	2	—	0	—	—	—
STX (opr)	Store X in Memory	M \leftarrow X	DIR EXT IX2 IX1 IX	BF	dd	2	4	—	—	—	—	—
				CF	hh ll	3		—	—	—	—	
				DF	ee ff	3		—	—	—	—	
				EF	ff	2		—	—	—	—	
				FF		1		—	—	—	—	
SUB (opr)	Subtract	ACCA \leftarrow ACCA - M	IMM DIR EXT IX2 IX1 IX	A0	ii	2	2	—	—	—	—	—
				B0	dd	2		—	—	—	—	
				C0	hh ll	3		—	—	—	—	
				D0	ee ff	3		—	—	—	—	
				E0	ff	2		—	—	—	—	
F0		1	—	—	—	—						

CWI	Software Interrupt	PC \blacktriangleleft PC + 0001 (SP) \blacktriangleleft PCL; SP \blacktriangleleft SP - 0001 (SP) \blacktriangleleft PCH; SP \blacktriangleleft SP - 0001 (SP) \blacktriangleleft X; SP \blacktriangleleft SP - 0001 (SP) \blacktriangleleft ACCA; SP \blacktriangleleft SP - 0001 (SP) \blacktriangleleft CC; SP \blacktriangleleft SP - 0001 I bit \blacktriangleleft 1 PCH \blacktriangleleft n - 0003 (vector) PCL \blacktriangleleft n - 0002 fetch	INH	83			1	10	1					
AX	Transfer A to X	X \blacktriangleleft ACCA	INH	97			1	2						
TST (opr) STA STX TST (opr) TST (opr)	Test for Negative or Zero	M - 0	DIR	3D			2	4						
			INH(A)	4D			1	3						
			INH(X)	5D			1	3						
			IX1	6D			2	5						
			IX	7D			1	4						
TXA	Transfer X to A	ACCA \blacktriangleleft X	INH	9F			1	2						
WAIT	Enable Interrupts, Halt CPU		INH	8F			1	2						



Freescale Semiconductor, Inc.
MC68HC05C4/C8
MC68HCL05C4/C8 AND
MC68HSC05C4/C8
MC68HC705C8

PIN ASSIGNMENTS

40-PIN DUAL-IN-LINE PACKAGE

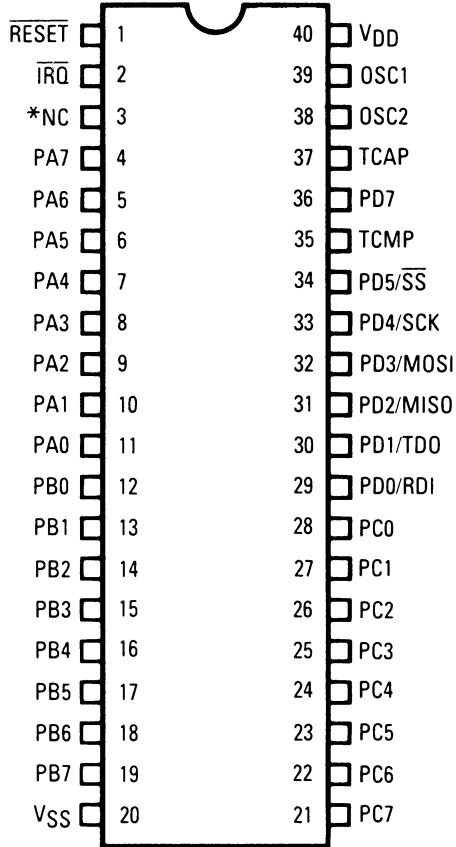

44-LEAD PLCC PACKAGE

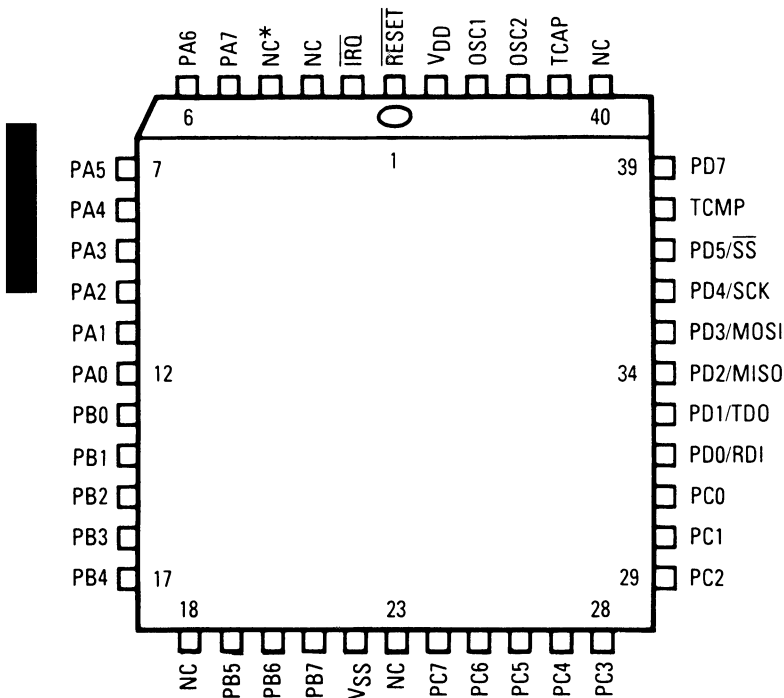

NOTE: Bulk substrate tied to VSS.

For More Information On This Product,
 * This pin is VPP on the MC68HC705C8
Go to: www.freescale.com

PIN ASSIGNMENTS

40-PIN DUAL-IN-LINE PACKAGE

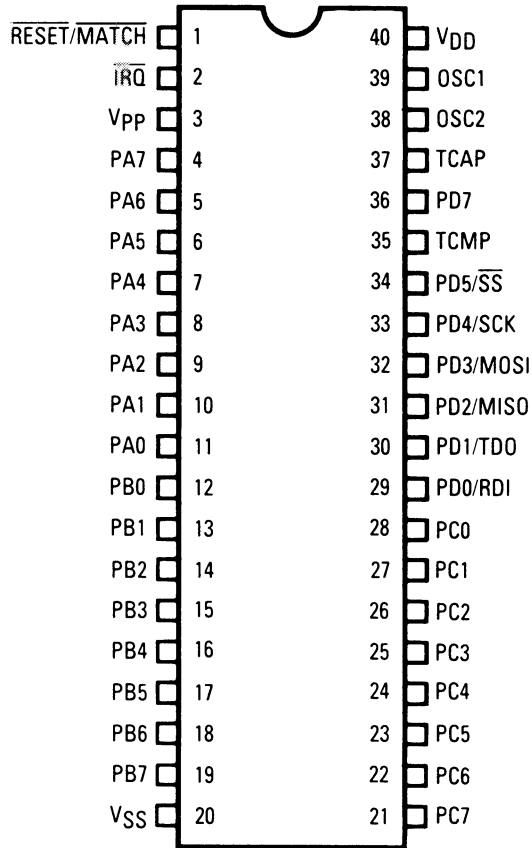

44-LEAD PLCC PACKAGE

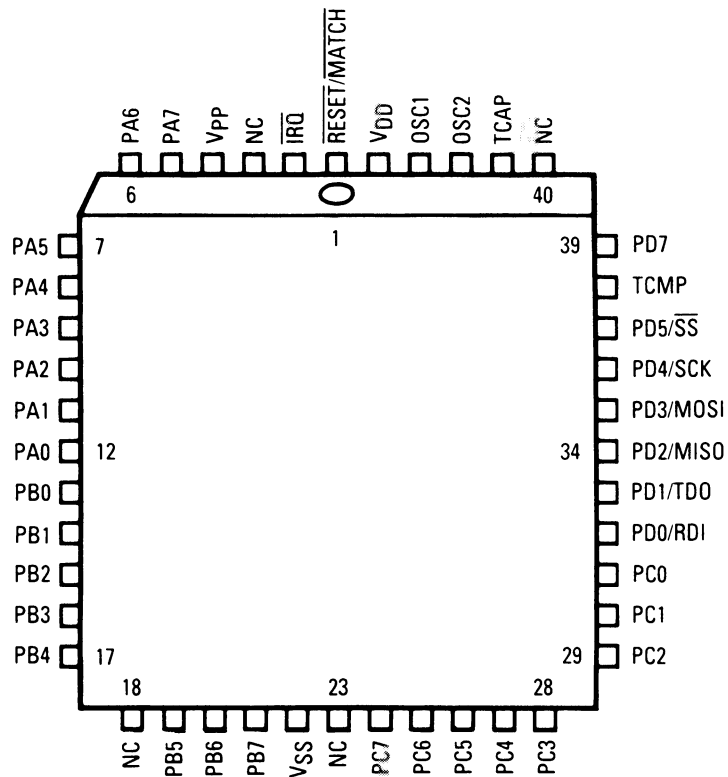

For More Information On This Product,
Go to: www.freescale.com

NOTE: Bulk substrate tied to VSS.

Freescale Semiconductor, Inc.
MC68HC05C9 (ONLY)

PIN ASSIGNMENTS

40-PIN DUAL-IN-LINE PACKAGE

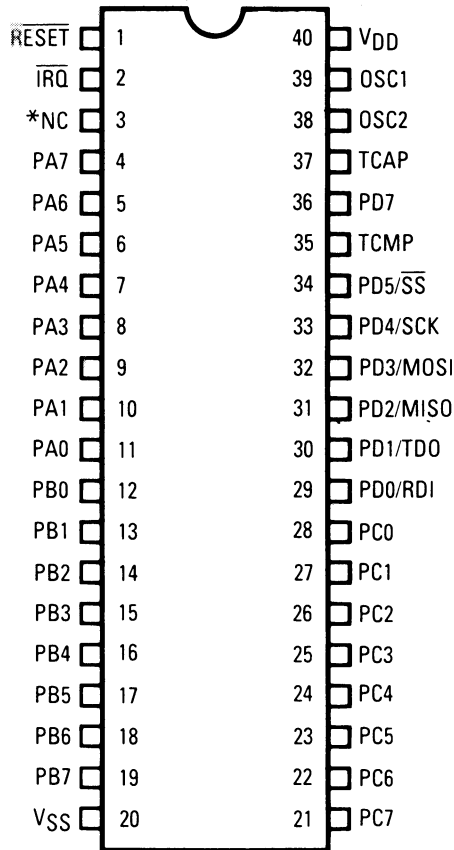

44-LEAD PLCC PACKAGE

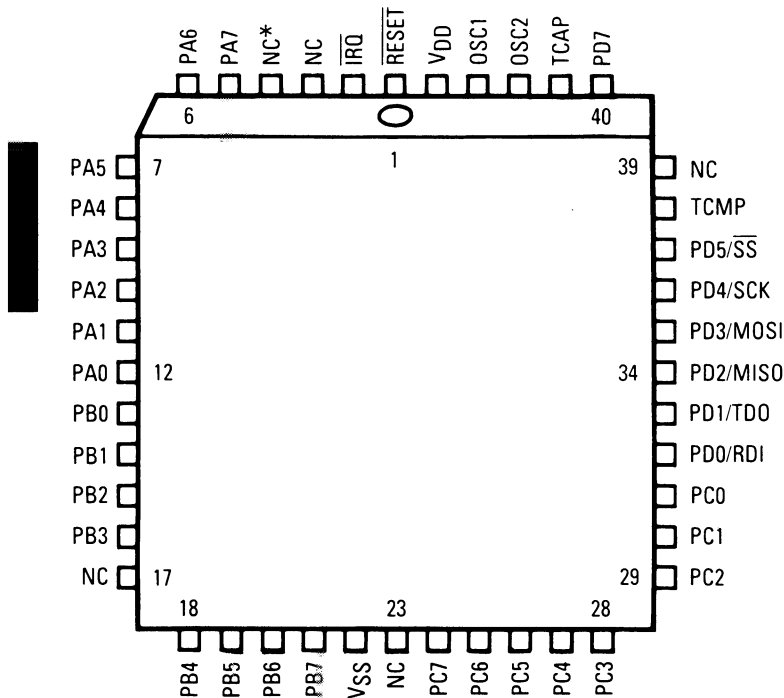

NOTE: Bulk substrate tied to VSS.

For More Information On This Product,
 *This pin is VPP on the MC68HC705C8.
Go to: www.freescale.com

Freescale Semiconductor, Inc. HEX/DEC CONVERSION

HEXADECIMAL AND DECIMAL CONVERSION

How to use:

Conversion to Decimal: Find the decimal weights for corresponding hexadecimal characters beginning with the least significant character. The sum of the decimal weights is the decimal value of the hexadecimal number.

Conversion to Hexadecimal: Find the highest decimal value in the table which is lower than or equal to the decimal number to be converted. The corresponding hexadecimal character is the most significant. Subtract the decimal value found from the decimal number to be converted. With the difference repeat the process to find subsequent hexadecimal characters.

15		Byte			Byte			0	
Char		12	11	8	7	4	3	Char	
Hex	Dec	Hex	Dec	Hex	Dec	Hex	Dec	Hex	Dec
0	0	0	0	0	0	0	0	0	0
1	4,096	1	256	1	16	1	1	1	1
2	8,192	2	512	2	32	2	2	2	2
3	12,288	3	768	3	48	3	3	3	3
4	16,384	4	1,024	4	64	4	4	4	4
5	20,480	5	1,280	5	80	5	5	5	5
6	24,576	6	1,536	6	96	6	6	6	6
7	28,672	7	1,792	7	112	7	7	7	7
8	32,768	8	2,048	8	128	8	8	8	8
9	36,864	9	2,304	9	144	9	9	9	9
A	40,960	A	2,560	A	160	A	A	A	10
B	45,056	B	2,816	B	176	B	B	B	11
C	49,152	C	3,072	C	192	C	C	C	12
D	53,248	D	3,328	D	208	D	D	D	13
E	57,344	E	3,584	E	224	E	E	E	14
F	61,440	F	3,840	F	240	F	F	F	15

**For More Information On This Product,
Go to: www.freescale.com**





BLOCK DIAGRAMS

MEMORY MAPS

**REGISTER/CONTROL
BIT ASSIGNMENTS**

**INSTRUCTIONS
ADDRESSING MODES
EXECUTION TIMES**

MECHANICAL DATA

**HEX/DEC CONVERSION
ASCII CHART**

BLOCK DIAGRAMS

MEMORY MAPS

**REGISTER/CONTROL
BIT ASSIGNMENTS**

**INSTRUCTIONS
ADDRESSING MODES
EXECUTION TIMES**

MECHANICAL DATA

**HEX/DEC CONVERSION
ASCII CHART**

The MC68HC05 Family of HCMOS devices covered in this reference guide are as follows:

MC68HC05C4
MC68HC05C8
MC68HC05C9
MC68HC705C8
MC68HC805C4
MC68HCL05C4
MC68HCL05C8
MC68HSC05C4
MC68HSC05C8

Freescale Semiconductor, Inc.

Freescale Semiconductor, Inc.

Motorola reserves the right to make changes without further notice to any product herein. Motorola makes no warranty, representation or guarantee regarding the suitability of its products for any particular purpose, nor does Motorola assume any liability arising out of the application or use of any product or circuit, and specifically disclaims any and all liability, including without limitation consequential or incidental damages. "Typical" parameters which may be provided in Motorola data sheets and/or specifications can and do vary in different applications and actual performance may vary over time. All operating parameters, including "Typicals" must be validated for each customer application by customer's technical experts. Motorola does not convey any license under its patent rights nor the rights of others. Motorola products are not designed, intended, or authorized for use as components in systems intended for surgical implant into the body, or other applications intended to support or sustain life, or for any other application in which the failure of the Motorola products could create a situation where personal injury or death may occur. Should Buyer purchase or use Motorola products for any such unintended or unauthorized application, Buyer shall indemnify and hold Motorola and its officers, employees, subsidiaries, affiliates, and distributors harmless against all claims, costs, damages, and expenses, and reasonable attorney fees arising out of, directly or indirectly, any claim of personal injury or death associated with such unintended or unauthorized use, even if such claim alleges that Motorola was negligent regarding the design or manufacture of the part. Motorola and  are registered trademarks of Motorola, Inc. Motorola, Inc. is an Equal Opportunity/Affirmative Action Employer.

Mfax is a trademark of Motorola, Inc.

How to reach us:

USA/EUROPE/Locations Not Listed: Motorola Literature Distribution;

P.O. Box 5405, Denver, Colorado 80217. 303-675-2140 or 1-800-441-2447

Mfax™. RMFAX0@email.sps.mot.com – TOUCHTONE 602-244-6609

– US & Canada ONLY 1-800-774-1848

INTERNET: <http://motorola.com/sps>

JAPAN: Nippon Motorola Ltd.; SPD, Strategic Planning Office, 4-32-1, Nishi-

Gotanda, Shinagawa-ku, Tokyo 141, Japan. 81-3-5487-8488

ASIA/PACIFIC: Motorola Semiconductors H.K. Ltd.; 8B Tai Ping Industrial Park,

51 Ting Kok Road, Tai Po, N.T., Hong Kong. 852-26629298



MOTOROLA

For More Information On This Product,

Go to: www.freescale.com