



晶采光電科技股份有限公司

www.DataSheet4U.com

AMPIRE CO., LTD.

SPECIFICATIONS FOR LCD MODULE

CUSTOMER	
CUSTOMER PART NO.	
AMPIRE PART NO.	AM-800480LTMQW-TW0H
APPROVED BY	
DATE	

Approved For Specifications

Approved For Specifications & Sample

AMPIRE CO., LTD.

**2F., No.88, Sec. 1, Sintai 5th Rd., Sijih City, Taipei County 221,
Taiwan (R.O.C.)台北縣汐止市新台五路一段 88 號 2 樓(東方科學園區 D 棟)**

TEL:886-2-26967269 , FAX:886-2-26967196 or 26967270

APPROVED BY	CHECKED BY	ORGANIZED BY

RECORD OF REVISION

Revision Date	Page	Contents	Editor
2009/12/16	-	New Release AM800480L+LCD Controller + 8080 interface Touch Panel	Kokai

1 Features

5 inch Amorphous-TFT-LCD (Thin Film Transistor Liquid Crystal Display) module. This module is composed of a 5" TFT-LCD panel, LCD controller, power driver circuit, LED driver circuit and backlight unit.

1.1 TFT Panel Feature :

- (1) Construction: 5" a-Si color TFT-LCD, White LED Backlight, **Touch Panel** and PCB.
- (2) Resolution (pixel): 800(R.G.B) X480
- (3) Number of the Colors : Real 262K colors (R , G , B 6 bit digital each)
- (4) LCD type : Transmissive Color TFT LCD (normally White)
- (5) Interface: 40 pin pitch 0.5 FFC
- (6) Power Supply Voltage: 3.3V single power input. Built-in power supply circuit.

1.2 LCD Controller Feature:

- (1) MCU interface: i80/M68 series MCU interface (**default: i80 series**).

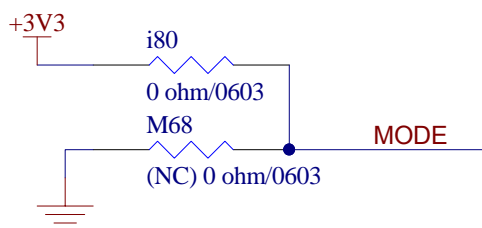

i80=0 ohm , M68=NC

- (2) Pixel data format: 8, 9, 16 and 18 bit. (Select by REG[0x80])
- (3) Display RAM size: Built-in 1215K bytes frame buffer. Support up to 864 x 480 at 24bpp display.
- (4) Arbitrary display memory starts position selection.
- (5) 16 bit interface support 65K (R5 G6 B5) Color.

2 Physical specifications

Item	Specifications	Unit
Display resolution(dot)	2400(W) x 480(H)	dot
Active area	108.0(W) x 64.8(H)	mm
Screen size	5(Diagonal)	inch
Pixel size	0.135 (W) x 0.135(H)	mm
Color configuration	R.G.B stripe	
Overall dimension	118.5(W)x77.1(H) x 7.377(D)	mm
Weight	T.B.D	g
Backlight unit	LED	

3 Electrical specification

3.1 Absolute max. ratings

3.1.1 Electrical Absolute max. ratings

Item	Symbol	Condition	Min.	Max.	Unit	Remark
Power voltage	VDD	VSS=0	-0.3	4.6	V	
Input voltage	V _{in}		-0.3	VDD+0.3	V	Note 1

Note1: /CS,/WR,/RD,RS,DB0~DN17

3.1.2 Environmental Absolute max. ratings

Item	OPERATING		STORAGE		Remark
	MIN	MAX	MIN	MAX	
Temperature	-20	70	-30	80	Note2,3,4,5,6,7
Humidity	Note1		Note1		
Corrosive Gas	Not Acceptable		Not Acceptable		

Note1 : Ta ≤ 40°C : 85% RH max

Ta > 40°C : Absolute humidity must be lower than the humidity of 85%RH at 40°C

Note2 : For storage condition Ta at -30°C < 48h , at 80°C < 100h

For operating condition Ta at -20°C < 100h

Note3 : Background color changes slightly depending on ambient temperature. This phenomenon is reversible.

Note4 : The response time will be slower at low temperature.

Note5 : Only operation is guaranteed at operating temperature. Contrast , response time, another display quality are evaluated at +25°C

Note6 :

- LED BL : When LCM is operated over 40°C ambient temperature, the I_{LED} of the LED back-light should be follow :

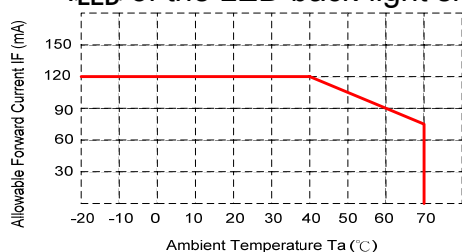

Note7 : This is panel surface temperature, not ambient temperature.

Note8 :

- LED BL: When LCM be operated over than 40°C, the life time of the LED back-light will be reduced.

3.2 Electrical characteristics

3.2.1 DC Electrical characteristic of the LCD

Typical operating conditions (VSS=0V)

Item	Symbol	Min.	Typ.	Max.	Unit	Remark
Power supply	VDD	3.0	3.3	4	V	
Input Voltage for logic	H Level	V_{IH}	0.7 VDD	--	VDD	Note 1
	L Level	V_{IL}	VSS	--	0.3 VDD	
Power Supply current	IDD	-	T.B.D	-	mA	Note 2

Note 1: MCU Interface controller and I/O pin.

Note 2: fV =60Hz , Ta=25°C , Display pattern : All Black

*:Will be reference only

3.2.2 Electrical characteristic of LED Back-light

Parameter	Symbol	Min.	Typ.	Max.	Unit	Condition
LED voltage	V_{AK}	--	9.9	10.8	V	I_{LED} =108mA, Ta=25°C
LED forward current	I_{LED}	--	108	120	mA	Ta=25°C
Lamp life time		--	T.B.D.	-	Hr	I_{LED} =40mA, Ta=25°C

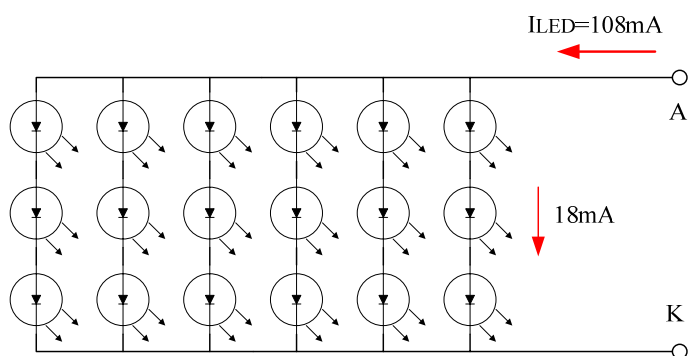

- The constant current source is needed for white LED back-light driving.

When LCM is operated over 60°C ambient temperature, the I_{LED} of the LED

back-light should be adjusted to 15mA max(For one dice LED).

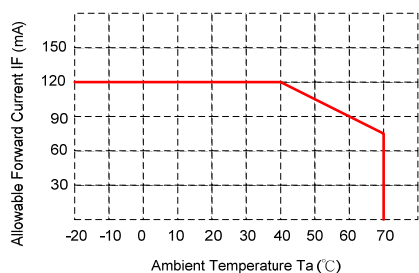

3.2.3 PWM Dimming Control

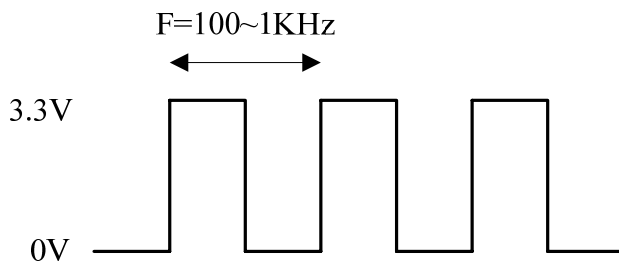
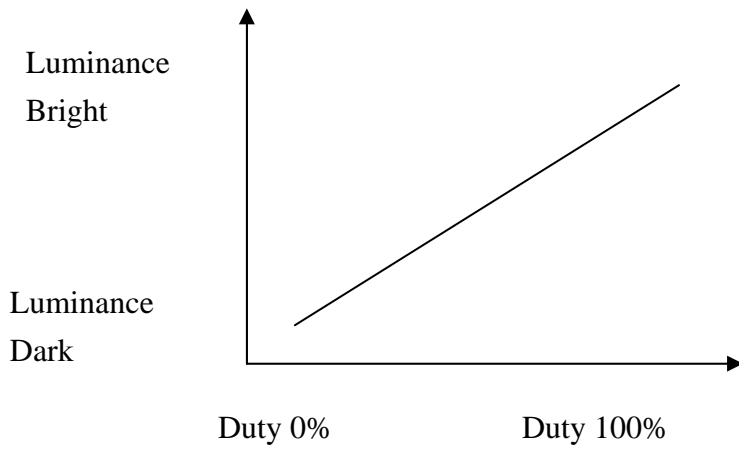

Note: the PWM dimming control by register 0xBE (software).

4 Optical specification

4.1 Optical characteristic:

Item	Symbol	Condition	Min.	Typ.	Max.	Unit	Note	
Viewing Angle	Front	θf	--	70	--	deg.	(1)(2)(3)	
	Back	θb	--	50	--			
	Left	θl	--	70	--			
	Right	θr	--	70	--			
Contrast ratio		CR	$\Theta=\Phi=0^\circ$	150	250	--	--	(1)(3)
Response Time		T_r	$\Theta=\Phi=0^\circ$	--	15	30	ms	(1)(4)
		T_f	$\Theta=\Phi=0^\circ$	--	35	50	ms	(1)(4)
Color chromaticity	Red	Rx	$\Theta=\Phi=0^\circ$	0.585	0.615	0.645	--	(1)
		Ry		0.314	0.344	0.374		
	Green	Gx		0.277	0.307	0.337		
		Gy		0.532	0.562	0.592		
	Blue	Bx		0.103	0.133	0.163		
		By		0.120	0.150	0.180		
	White	Wx		0.279	0.309	0.339		
		Wy		0.320	0.350	0.380		
Luminance		L	$\Theta=\Phi=0^\circ$	-	360	--	cd/m ²	(1)(5) (ILED=125mA)
Luminance Uniformity		ΔL	$\Theta=\Phi=0^\circ$	70	-	-	%	(1)(5)(6)

Note 1: Ta=25°C. To be measured on the center area of panel after 10 minutes operation.

Note 2: Definition of Viewing Angle

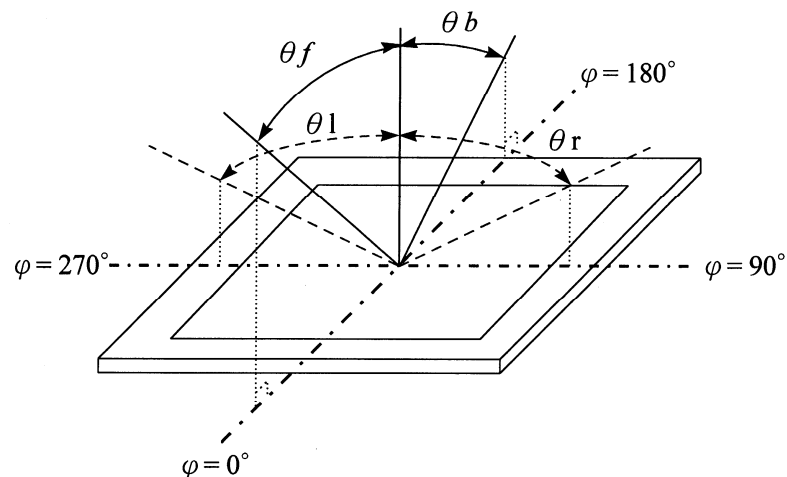

Note 3: Definition of contrast ratio:

Contrast ratio is calculated with the following formula.

www.DataSheet4U.com

$$\text{Contrast ratio(CR)} = \frac{\text{Photo detector output when LCD is at "White" state}}{\text{Photo detector Output when LCD is at "Black" state}}$$

Note 4: Definition of response time:

The output signals of photo detector are measured when the input signals are changed from "black" to "white" (falling time) and from "white" to "black" (rising time) respectively. The response time is defined as the time interval between the 10% and 90% of amplitudes. Refer to figure as below.

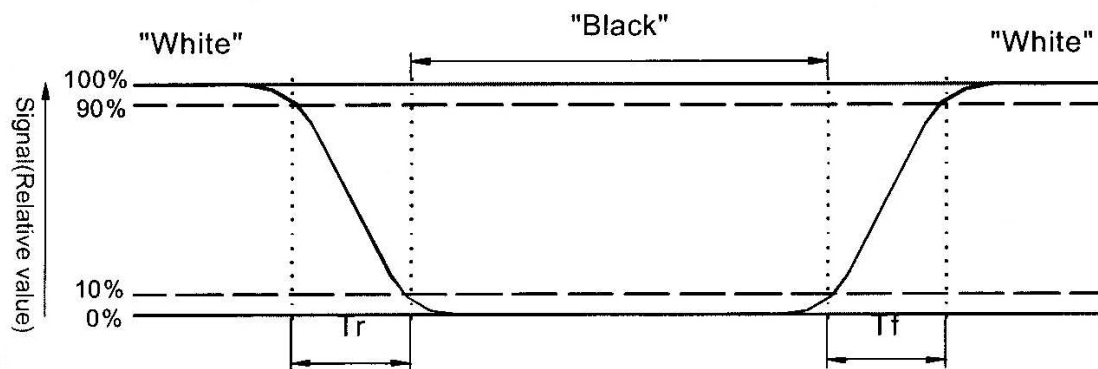

Note 5 : Luminance is measured at point 5 of the display.

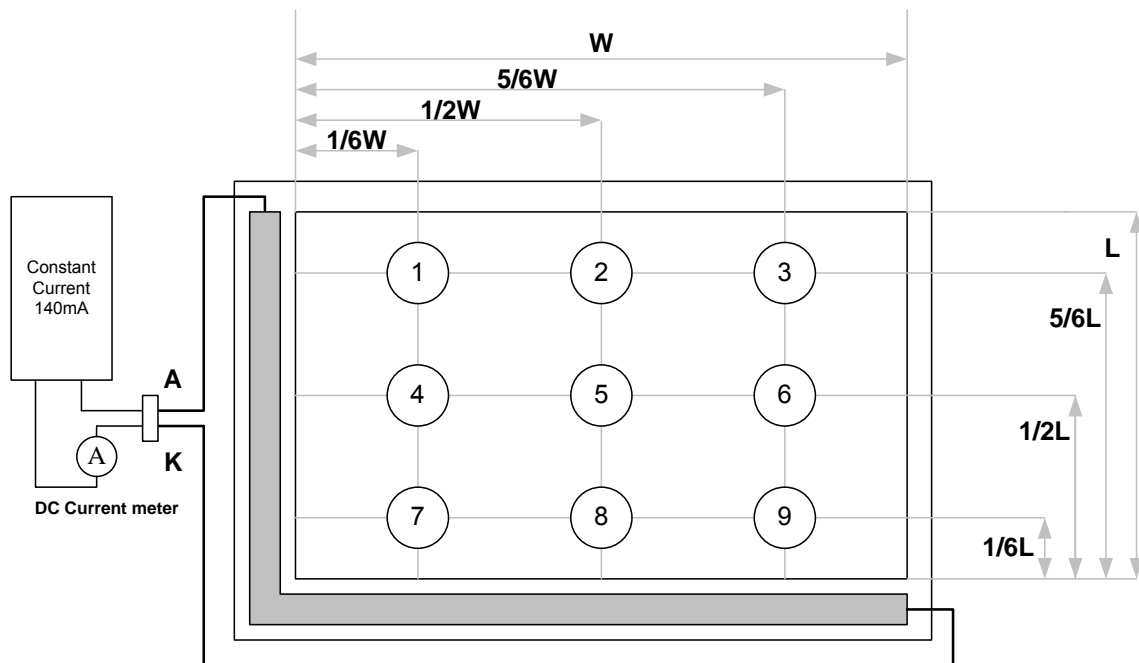

Note 6 : Definition of Luminance Uniformity

$$\Delta L = [L(\text{min.}) \text{ of 9 points} / L(\text{max.}) \text{ of 9 points}] \times 100\%$$

4.2 Optical characteristic of the LED Back-light

www.DataSheet4U.com

ITEM	MIN	TYP	MAX	UNIT	Condition
Bare Brightness	2800	--	--	Cd/m ²	$I_{LED} = 40\text{mA}, T_a = 25^\circ\text{C}$
AVG. X of 1931 C.I.E.	0.26	0.30	0.34	--	$I_{LED} = 40\text{mA}, T_a = 25^\circ\text{C}$
AVG. Y of 1931 C.I.E.	0.27	0.31	0.35	--	$I_{LED} = 40\text{mA}, T_a = 25^\circ\text{C}$
Brightness Uniformity	75	--	--	%	$I_{LED} = 40\text{mA}, T_a = 25^\circ\text{C}$

() For reference only. These data should be update according the prototype.

Note1 : Measurement after 10 minutes from LED BL operating.

Note2 : Measurement of the following 9 places on the display.

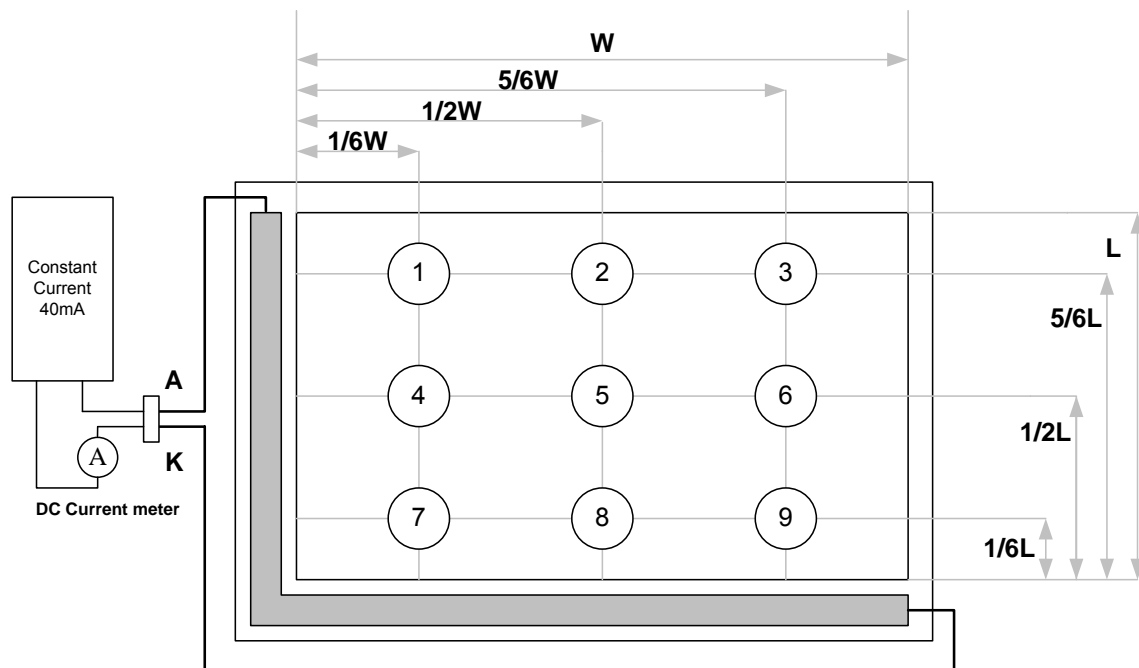

Note3: The Uniformity definition

$(\text{Min Brightness} / \text{Max Brightness}) \times 100\%$

4.3 Touch Panel Specification

Parameter	Condition	Standard Value
Terminal Resistance	X Axis	300 ~ 1100 Ω
	Y Axis	100 ~ 700 Ω
Insulating Resistance	DC 25 V	More than 10M Ω
Linearity	--	Under $\pm 1.5\%$ *
Notes life by Pen	Note a	1,00,000 times(min)
Input life by finger	Note a	1,000,000 times (min)

* after environmental & life test Linearity $\leq 3.0\%$

Note a

Measurement condition of minimum input force

Resistance between X & Y axis must be equal or lower than 2k Ω ($R_{on} \leq 2k\Omega$) .

Interface

No.	Symbol	Function
1	XR	Touch Panel Right Signal in X Axis
2	YD	Touch Panel Bottom Signal in Y Axis
3	XL	Touch Panel Left Signal in X Axis
4	YT	Touch Panel Top Signal in Y Axis

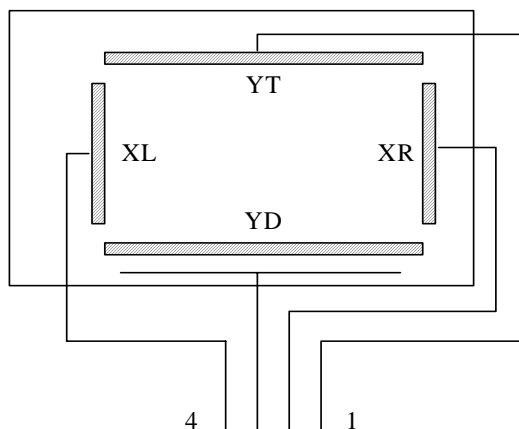

5 Interface specifications

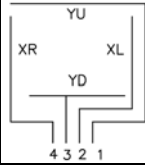
Pin no	Symbol	I/O	Description	Remark
1	DGND	-	GND	
2				
3	VLED	-	Power supply for the LED driver IC (3.3V-5V).	
4	NC	-	Must be floating.	
5	/RESET		Reset signal for TFT LCD controller.	
6	RS		Register and Data select for TFT LCD controller.	
7	/CS		Chip select low active signal for TFT LCD controller.	
8	/WR		80mode: /WR low active signal for TFT LCD controller. 68mode: E signal latch on rising edge.	
9	/RD		80mode: /RD low active signal for TFT LCD controller. 68mode: R/W signal Hi: read, Lo: write.	
10	DB0		Data bus.	
11	DB1			
12	DB2			
13	DB3			
14	DB4			
15	DB5			
16	DB6			
17	DB7			
18	DB8			
19	DB9			
20	DB10			
21	DB11			
22	DB12			
23	DB13			
24	DB14			
25	DB15			
26	DB16			
27	DB17			
28	NC	-	Must be floating.	
29	DGND	-	GND	
30	SK/X1	-	Touch Panel XL	
31	DO/X2	-	Touch Panel XR	
32	DI/Y1	-	Touch Panel YU	
33	TPCS/Y2	-	Touch Panel YD	
34	IRQ	-		
35-37	VDD	-	Power supply for the logic (3.3V).	
38-40	DGND	-	GND.	

6 NBLOCK DIAGRAM

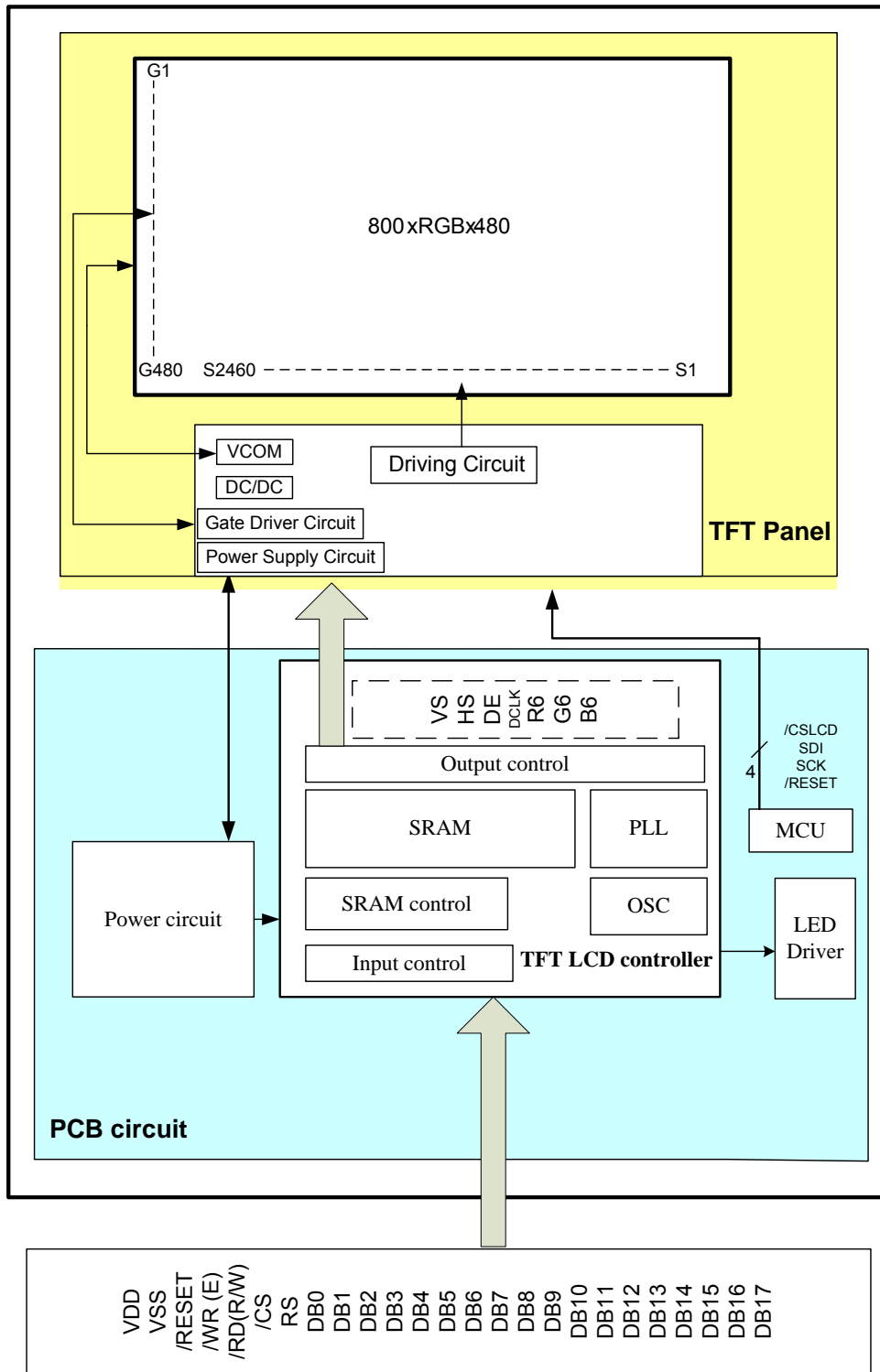

7 Interface Protocol

7.1 M68 Series

Symbol	Parameter	Min	Typ	Max	Unit
t_{CYC}	Reference Clock Cycle Time	9	-	-	ns
t_{PWCSL}	Pulse width CS# or E low	1	-	-	t_{CYC}
t_{PWCSH}	Pulse width CS# or E high	1	-	-	t_{CYC}
t_{FDRD}	First Data Read Delay	5	-	-	t_{CYC}
t_{AS}	Address Setup Time	1	-	-	ns
t_{AH}	Address Hold Time	1	-	-	ns
t_{DSW}	Data Setup Time	4	-	-	ns
t_{DHW}	Data Hold Time	1	-	-	ns
t_{DSR}	Data Access Time	-	-	5	ns
t_{DHR}	Output Hold time	1	-	-	ns

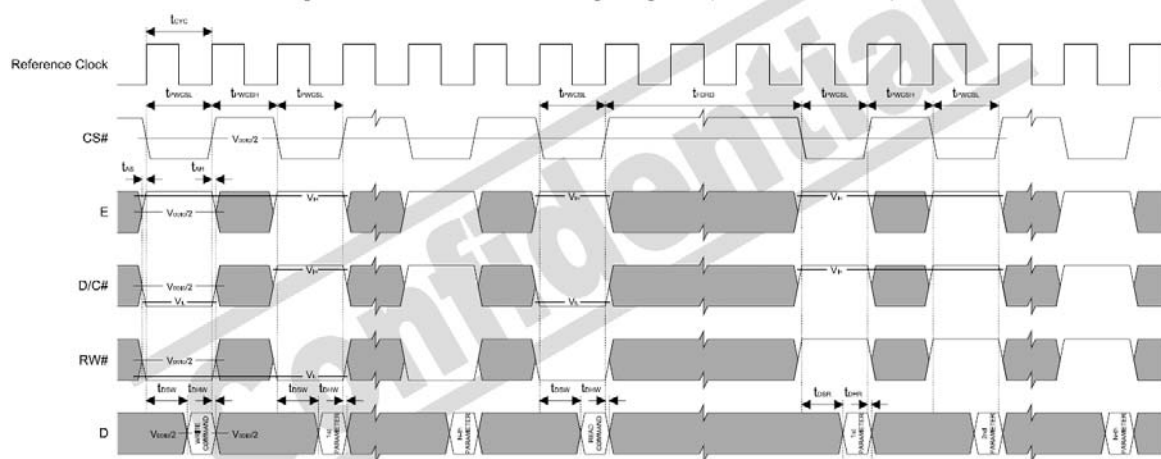

6800 Mode Timing Diagram (Use CS# as Clock)

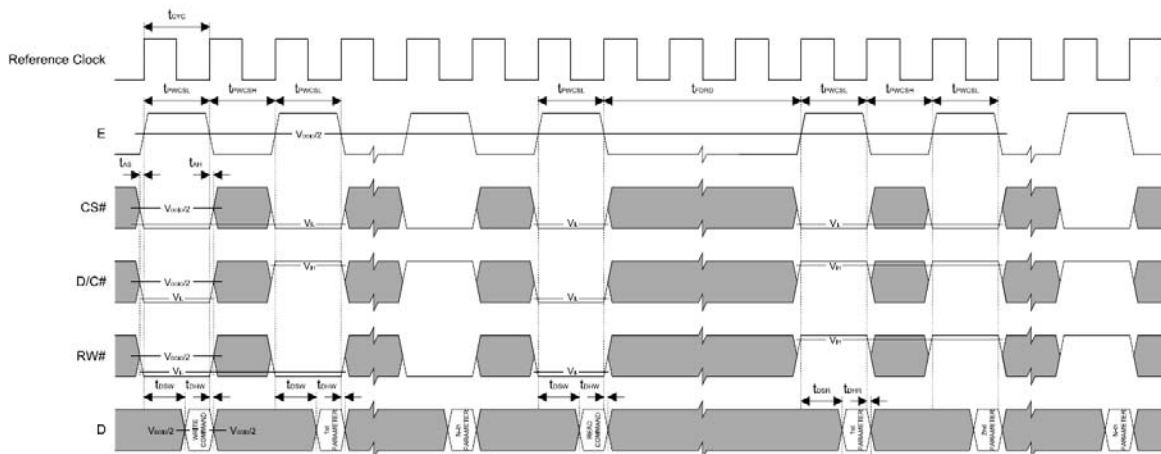

6800 Mode Timing Diagram (Use E as Clock)

7.2 i80 Series

Symbol	Parameter	Min	Typ	Max	Unit
t_{cyc}	Reference Clock Cycle Time	9	-	-	ns
t_{pwCSL}	Pulse width CS# low	1	-	-	t_{cyc}
t_{pwCSH}	Pulse width CS# high	1	-	-	t_{cyc}
t_{FDRD}	First Read Data Delay	5	-	-	t_{cyc}
t_{AS}	Address Setup Time	1	-	-	ns
t_{AH}	Address Hold Time	1	-	-	ns
t_{DSW}	Data Setup Time	4	-	-	ns
t_{DHW}	Data Hold Time	1	-	-	ns
t_{DSR}	Data Access Time	-	-	5	ns
t_{DHR}	Output Hold time	1	-	-	ns

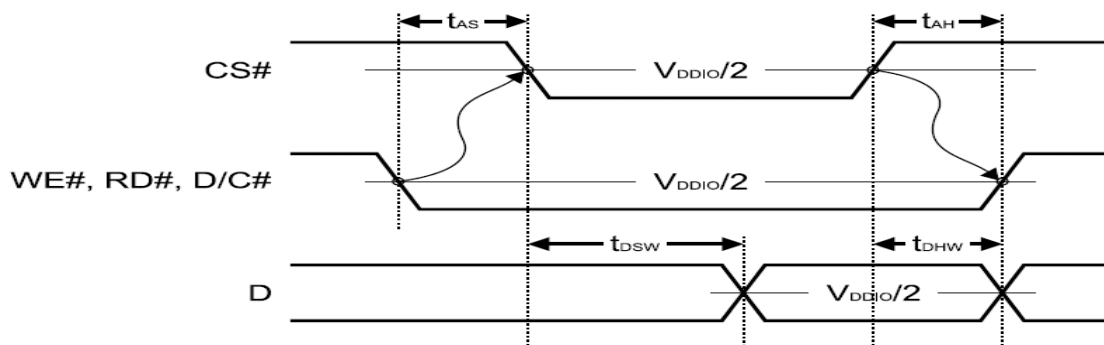
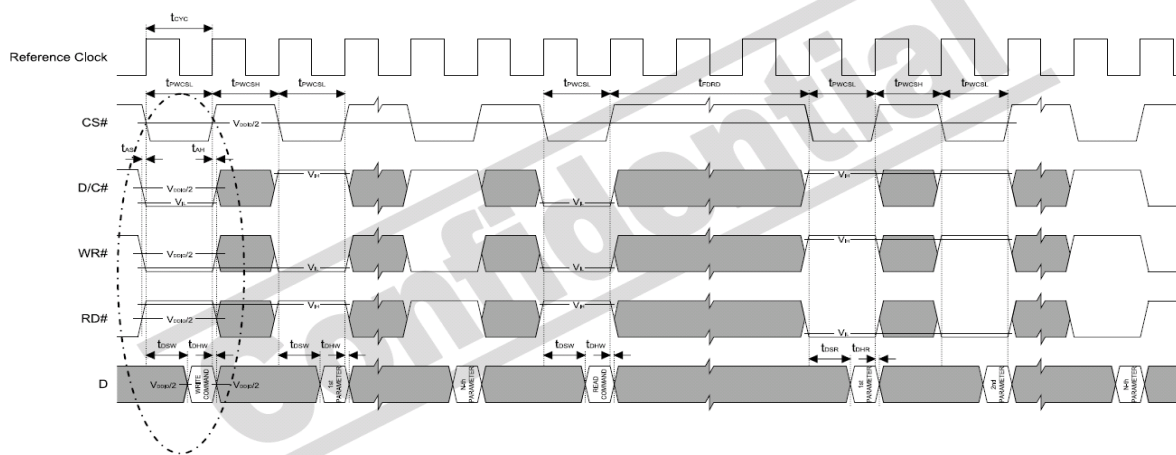

7.3 Data transfer order Setting

Interface	Cycle	D[23]	D[22]	D[21]	D[20]	D[19]	D[18]	D[17]	D[16]	D[15]	D[14]	D[13]	D[12]	D[11]	D[10]	D[9]	D[8]	D[7]	D[6]	D[5]	D[4]	D[3]	D[2]	D[1]	D[0]	
24 bits	1 st	R7	R6	R5	R4	R3	R2	R1	R0	G7	G6	G5	G4	G3	G2	G1	G0	B7	B6	B5	B4	B3	B2	B1	B0	
18 bits	1 st							R5	R4	R3	R2	R1	R0	G5	G4	G3	G2	G1	G0	B5	B4	B3	B2	B1	B0	
16 bits (565 format)	1 st									R5	R4	R3	R2	R1	G5	G4	G3	G2	G1	G0	B5	B4	B3	B2	B1	
16 bits	1 st									R5	R4	R3	R2	R1	R0	X	X	G5	G4	G3	G2	G1	G0	X	X	
	2 nd									B5	B4	B3	B2	B1	B0	X	X	R5	R4	R3	R2	R1	R0	X	X	
	3 rd									G5	G4	G3	G2	G1	G0	X	X	B5	B4	B3	B2	B1	B0	X	X	
9 bits	1 st																	R5	R4	R3	R2	R1	R0	G5	G4	G3
	2 nd																	G2	G1	G0	B5	B4	B3	B2	B1	B0
8 bits	1 st																	R5	R4	R3	R2	R1	R0	X	X	
	2 nd																	G5	G4	G3	G2	G1	G0	X	X	
	3 rd																	B5	B4	B3	B2	B1	B0	X	X	

X: Don't Care

8 Command Table

Hex Code	Command	Description
0x 00	nop	No operation
0x 01	soft_reset	Software Reset
0x 0A	get_power_mode	Get the current power mode
0x 0B	get_address_mode	Get the frame memory to the display panel read order
0x 0C	get_pixel_format	Get the current pixel format
0x 0D	get_display_mode	The display module returns the Display Signal Mode.
0x 0E	get_signal_mode	Get the current display mode from the peripheral
0x 10	enter_sleep_mode	Turn off the panel. This command will pull low the GPIO0. If GPIO0 is configured as normal GPIO or LCD miscellaneous signal with command set_gpio_conf, this command will be ignored.
0x 11	exit_sleep_mode	Turn on the panel. This command will pull high the GPIO0. If GPIO0 is configured as normal GPIO or LCD miscellaneous signal with command set_gpio_conf, this command will be ignored.
0x 12	enter_partial_mode	Part of the display area is used for image display.
0x 13	enter_normal_mode	The whole display area is used for image display.
0x 20	exit_invert_mode	Displayed image colors are not inverted.
0x 21	enter_invert_mode	Displayed image colors are inverted.
0x 26	set_gamma_curve	Selects the gamma curve used by the display device.
0x 28	set_display_off	Blanks the display device.
0x 29	set_display_on	Show the image on the display device.
0x 2A	set_column_address	Set the column extent.
0x 2B	set_page_address	Set the page extent.
0x 2C	write_memory_start	Transfer image information from the host processor interface to the peripheral starting at the location provided by set_column_address and set_page_address.
0x 2E	read_memory_start	Transfer image data from the peripheral to the host processor interface starting at the location provided by set_column_address and set_page_address.
0x 30	set_partial_area	Defines the partial display area on the display device.
0x 33	set_scroll_area	Defines the vertical scrolling and fixed area on display area.
0x 34	set_tear_off	Synchronization information is not sent from the display module to the host processor.
0x 35	set_tear_on	Synchronization information is sent from the display module to the host processor at the start of VFP.
0x 36	set_address_mode	Set the read order from frame buffer to the display panel.
0x 37	set_scroll_start	Defines the vertical scrolling starting point.
0x 38	exit_idle_mode	Full color depth is used for the display panel.
0x 39	enter_idle_mode	Reduce color depth is used on the display panel.
0x 3A	set_pixel_format	Defines how many bits per pixel are used in the interface.
0x 3C	write_memory_continue	Transfer image information from the host processor interface to the peripheral from the last written location.
0x 3E	read_memory_continue	Read image data from the peripheral continuing after the last read_memory_continue or read_memory_start.
0x 44	set_tear_scanline	Synchronization information is sent from the display module to the host processor when the display device refresh reaches the provided scan line.
0x 45	get_scanline	Get the current scan line.
0x A1	read_ddb	Read the DDB from the provided location.
0x B0	set_lcd_mode_pad_size	Set the LCD panel mode (RGB TFT or TTL).
0x B1	get_lcd_mode_pad_size	Get the current LCD panel mode, pad strength and resolution.
0x B4	set_hori_period	Set front porch.
0x B5	get_hori_period	Get current front porch settings.
0x B6	set_vert_period	Set the vertical blanking interval between last scan line and next LFRAME pulse.
0x B7	get_vert_period	Set the vertical blanking interval between last scan line and next LFRAME pulse.
0x B8	set_gpio_conf	Set the GPIO configuration.

		If the GPIO is not used for LCD, set the direction. Otherwise, they are toggled with LCD signals. www.DataSheet4U.com
0x B9	get_gpio_conf	Get the current GPIO configuration.
0x BA	set_gpio_value	Set GPIO value for GPIO configured as output.
0x BB	get_gpio_status	Read current GPIO status. If the individual GPIO was configured as input, the value is the status of the corresponding pin. Otherwise, it is the programmed value.
0x BC	set_post_proc	Set the image post processor.
0x BD	get_post_proc	Set the image post processor.
0x BE	set_pwm_conf	Set the image post processor.
0x BF	get_pwm_conf	Set the image post processor.
0x C0	set_lcd_gen0	Set the rise, fall, period and toggling properties of LCD signal generator 0
0x C1	get_lcd_gen0	Get the current settings of LCD signal generator 0
0x C2	set_lcd_gen1	Set the rise, fall, period and toggling properties of LCD signal generator 1.
0x C3	get_lcd_gen1	Get the current settings of LCD signal generator 1.
0x C4	set_lcd_gen2	Set the rise, fall, period and toggling properties of LCD signal generator 2.
0x C5	get_lcd_gen2	Get the current settings of LCD signal generator 2.
0x C6	set_lcd_gen3	Set the rise, fall, period and toggling properties of LCD signal generator 3.
0x C7	get_lcd_gen3	Get the current settings of LCD signal generator 3.
0x C8	set_gpio0_rop	Set the GPIO0 with respect to the LCD signal generators using ROP3 operation. No effect if the GPIO0 is configured as general GPIO.
0x C9.	get_gpio0_rop	Get the GPIO0 properties with respect to the LCD signal generators.
0x CA	set_gpio1_rop	Set the GPIO1 with respect to the LCD signal generators using ROP3 operation. No effect if the GPIO1 is configured as general GPIO.
0x CB	get_gpio1_rop	Get the GPIO1 properties with respect to the LCD signal generators.
0x CC	set_gpio2_rop	Set the GPIO2 with respect to the LCD signal generators using ROP3 operation. No effect if the GPIO2 is configured as general GPIO.
0x CD	get_gpio2_rop	Get the GPIO2 properties with respect to the LCD signal generators.
0x CE	set_gpio3_rop	Set the GPIO3 with respect to the LCD signal generators using ROP3 operation. No effect if the GPIO3 is configured as general GPIO.
0x CF	get_gpio3_rop	Get the GPIO3 properties with respect to the LCD signal generators.
0x D0	set_abc_dbc_conf	Set the ambient back light and dynamic back light configuration.
0x D1	get_abc_dbc_conf	Get the ambient back light and current dynamic back light configuration.
0x D4	set_dbc_th	Set the threshold for each level of power saving.
0x D5	get_dbc_th	Get the threshold for each level of power saving.
0x E0	set_pll_start	Start the PLL. Before the start, the system was operated with the crystal oscillator or clock input.
0x E2	set_pll_mnk	Set the PLL.
0x E3	get_pll_mnk	Get the PLL settings.
0x E4	get_pll_status	Get the current PLL status.
0x E5	set_deep_sleep	Set deep sleep mode.
0x E6	set_lshift_freq	Set the LSHIFT (pixel clock) frequency.
0x E7	get_lshift_freq	Get current LSHIFT (pixel clock) frequency setting.
0x F0	set_pixel_data_interface	Set the pixel data format of the parallel host processor interface.
0x F1	get_pixel_data_interface	Get the current pixel data format settings.

About the further detail, please refer the datasheet of SSD1963.

9 Initial sequence

```

#define u8 unsigned char
#define u16 unsigned int
#define u32 unsigned long
#define Resolution_X 800
#define Resolution_Y 480
#define H_Sync_Pluse_Wide 4
#define H_Sync_to_DE 20 // DE horizontal start position
#define H_Sync_total 928
#define V_Sync_Pluse_Wide 10
#define V_Sync_to_DE 12 // DE horizontal start position
#define V_Sync_total 525
#define REFRESH_RATE 60 //Hz
#define DCLK_Latch 0 // 0: Rising 1: Falling
#define H_Sync_polarity 0 // 0: Active low 1:Active High
#define V_Sync_polarity 0 // 0: Active low 1:Active High

// Make sure that the write timing is within spec.
#define LCD_WRITE_A0(REG_Index) outportb (0x20,REG_Index);
#define LCD_WRITE_A1(REG_DATA) outportb (0x21,REG_DATA);

#define PIXEL_CLOCK (u32)((u32)H_Sync_total * V_Sync_total * REFRESH_RATE)
#define OSC_FREQ 10000000L
#define MULTIPLIER_N 35
#define DIVIDER_M 2
#define VCO_FREQ (u32)(OSC_FREQ * (MULTIPLIER_N + 1))
#define PLL_FREQ (u32)(VCO_FREQ / (DIVIDER_M + 1))
#define CAL (u32)(((float)((float)PIXEL_CLOCK * 128) / (float)PLL_FREQ) * 8192)
#define LCDC_FPR (u32)(CAL - 1)
#define Polarity (1<<3)|(DCLK_Latch<<2)|(H_Sync_polarity<<2)|(V_Sync_polarity<<2)

```

```

void SSD1963_initial(void)
{

//设置 PLL 频率 Set PLL Frequency
//晶振频率*(MULTIPLIER_N+1)/(DIVIDER_M+1)
// 120Mhz
LCD_WRITE_A0(0xe2);
LCD_WRITE_A1(MULTIPLIER_N);
LCD_WRITE_A1(DIVIDER_M);
LCD_WRITE_A1(0x54);
//SET PLL
LCD_WRITE_A0(0xe0);
LCD_WRITE_A1(0x01);
k_delay(50); //ms
LCD_WRITE_A0(0xe0);
LCD_WRITE_A1(0x03);
//RESET
LCD_WRITE_A0(0x01);
k_delay(50);
// SET PIXEL CLOCK
LCD_WRITE_A0(0xE6);
LCD_WRITE_A1(((int)(LCDC_FPR&0x000F0000L)>>16));
LCD_WRITE_A1(((int)(LCDC_FPR&0x0000FF00L)>>8));
LCD_WRITE_A1(((int)(LCDC_FPR&0x000000FFL)));
//SET LCD MODE
LCD_WRITE_A0(0xb0);
LCD_WRITE_A1(Polarity);
LCD_WRITE_A1(0x00);
LCD_WRITE_A1(((Resolution_X-1)&0xFF00)>>8);
LCD_WRITE_A1( (Resolution_X-1)&0x00FF);
LCD_WRITE_A1(((Resolution_Y-1)&0xFF00)>>8);
LCD_WRITE_A1((Resolution_Y-1)&0x00FF);
//Set Horizontal Period
LCD_WRITE_A0( 0xb4);
LCD_WRITE_A1( ((H_Sync_total-1)&0xFF00)>>8);
LCD_WRITE_A1( (H_Sync_total-1)&0x00FF);
LCD_WRITE_A1( (H_Sync_to_DE&0x0700)>>8);
LCD_WRITE_A1( (H_Sync_to_DE)&0x00FF);
LCD_WRITE_A1( H_Sync_Pluse_Wide - 1);
LCD_WRITE_A1( 0x00);

```

```
LCD_WRITE_A1( 0x00);
//Set Vertical Period
LCD_WRITE_A0( 0xb6);
LCD_WRITE_A1( ((V_Sync_total-1)&0xFF00)>>8);
LCD_WRITE_A1( (V_Sync_total-1)&0x00FF);
LCD_WRITE_A1( (V_Sync_to_DE&0x0700)>>8);
LCD_WRITE_A1( (V_Sync_to_DE)&0x00FF);
LCD_WRITE_A1( V_Sync_Pluse_Wide - 1);
LCD_WRITE_A1( 0x00);
LCD_WRITE_A1( 0x00);
//Set Display On
LCD_WRITE_A0( 0x29);
k_delay(50);
//Set GPIO Configuration
LCD_WRITE_A0( 0xb8);
LCD_WRITE_A1( 0x0f);
LCD_WRITE_A1( 0x01);
//Get GPIO Configuration
//LCD_WRITE_A0( 0xb9);
//LCD_WRITE_A1( 0x0f);
//LCD_WRITE_A1( 0x01);
//Set GPIO Value
LCD_WRITE_A0( 0xba);
LCD_WRITE_A1( 0x03); // GPIO 2: Left / Right , GPIO3 : Upper /Down
//Set Column Address
LCD_WRITE_A0( 0x2a);
LCD_WRITE_A1( 0x00);
LCD_WRITE_A1( 0x00);
LCD_WRITE_A1( ((Resolution_X-1) & 0xFF00)>>8);
LCD_WRITE_A1( ((Resolution_X-1) & 0x00FF));
//Set Page Address
LCD_WRITE_A0( 0x2b);
LCD_WRITE_A1( 0x00);
LCD_WRITE_A1( 0x00);
LCD_WRITE_A1( ((Resolution_Y-1) & 0xFF00)>>8);
LCD_WRITE_A1( ((Resolution_Y-1) & 0x00FF));
//Set Address Mode
LCD_WRITE_A0( 0x36);
LCD_WRITE_A1( 0x00);
```

```

// PWM 设置 LED Back-light Brightness
LCD_WRITE_A0( 0xbe);
//设置 PWM 频率
// 120M /(8*256*256)=228.88hz
LCD_WRITE_A1( 0x08);
//设置占空比
LCD_WRITE_A1( 0xff); //0xff
LCD_WRITE_A1( 0x01);
//////////
LCD_WRITE_A1( 0xFF);
LCD_WRITE_A1( 0x00);
LCD_WRITE_A1( 0x00);
//////////
//Set DBC Threshold
LCD_WRITE_A0( 0xd4);
//TH1 0X1680 Conservative mode
//TH1 = display width * display height * 3 * 0.1 /16
LCD_WRITE_A1( 0x00);
LCD_WRITE_A1( 0x16);
LCD_WRITE_A1( 0x80);
//TH2 0X3840 Normal mode
///TH2 = display width * display height * 3 * 0.25 /16
LCD_WRITE_A1( 0x00);
LCD_WRITE_A1( 0x38);
LCD_WRITE_A1( 0x40);
//TH3 0X8700 Aggressive mode
LCD_WRITE_A1( 0x00);
LCD_WRITE_A1( 0x87);
LCD_WRITE_A1( 0x00);
//Set DBC Configuration
LCD_WRITE_A0( 0xd0);
//6 DBC Manual Brightness enable
//5 Transition effect enable :Transition effect is used to remove visible backlight flickering
//32 01 Conservative mode
LCD_WRITE_A1( (0<<6) | (1<<5) | (1<<2) | (1<<0));
//Set Pixel Data Interface
LCD_WRITE_A0( 0xf0);
LCD_WRITE_A1( 0x03); // Pixel Data interface format 0x03:16 Bit (565) , 0x00: 8Bit
}

```

```

void LCDC_RAM_WRITE_START(void)
{
LCD_WRITE_A0( 0x2C);
LCD_WRITE_A0( 0x3C);
}
void LCDC_WindowSet (int S_X,int S_Y,int E_X,int E_Y)
{
LCD_WRITE_A0( 0x2a);
LCD_WRITE_A1( (u8)((S_X>>8)) );
LCD_WRITE_A1( (u8)(S_X) );
LCD_WRITE_A1( (u8)((E_X-1)>>8) );
LCD_WRITE_A1( (u8)(E_X-1) );
LCD_WRITE_A0( 0x2b);
LCD_WRITE_A1( (u8)((S_Y>>8)) );
LCD_WRITE_A1( (u8)(S_Y) );
LCD_WRITE_A1( (u8)((E_Y-1)>>8) );
LCD_WRITE_A1( (u8)(E_Y-1) );
}
void LCDC_RAM_WRITE_COLOR(u16 color)
{
LCD_WRITE_A1(color);
}
void k_lcd_bar(int in_x, int in_y, int x_num, int y_num)
{
int k,l,x0,y0,x1,y1;
x0 = in_x;
y0 = in_y;
x1 = (in_x + x_num);
y1 = (in_y + y_num);

LCDC_WindowSet(x0,y0,x1,y1);
LCDC_RAM_WRITE_START();
for(k=y0;k<y1;k++)
{
for(l=x0;l<x1;l++)
{
LCDC_RAM_WRITE_COLOR(ui_bkcolor);
}
}
}
}

```

10 DISPLAYED COLOR AND INPUT DATA

	Color & Gray Scale	DATA SIGNAL																	
		R5	R4	R3	R2	R1	R0	G5	G4	G3	G2	G1	G0	B5	B4	B3	B2	B1	B0
Basic Color	Black	0	0	0	0	0	0	0	0	0	0	0	0	0	0	0	0	0	0
	Red(0)	1	1	1	1	1	1	0	0	0	0	0	0	0	0	0	0	0	0
	Green(0)	0	0	0	0	0	0	0	1	1	1	1	1	0	0	0	0	0	0
	Blue(0)	0	0	0	0	0	0	0	0	0	0	0	0	1	1	1	1	1	1
	Cyan	0	0	0	0	0	0	1	1	1	1	1	1	1	1	1	1	1	1
	Magenta	1	1	1	1	1	1	0	0	0	0	0	0	1	1	1	1	1	1
	Yellow	1	1	1	1	1	1	1	1	1	1	1	1	0	0	0	0	0	0
White	1	1	1	1	1	1	1	1	1	1	1	1	1	1	1	1	1	1	
Red	Black	0	0	0	0	0	0	0	0	0	0	0	0	0	0	0	0	0	0
	Red(62)	0	0	0	0	0	1	0	0	0	0	0	0	0	0	0	0	0	0
	Red(61)	0	0	0	0	0	1	0	0	0	0	0	0	0	0	0	0	0	0
	:	:	:	:	:	:	:	:	:	:	:	:	:	:	:	:	:	:	:
	Red(31)	0	1	1	1	1	1	0	0	0	0	0	0	0	0	0	0	0	0
	:	:	:	:	:	:	:	:	:	:	:	:	:	:	:	:	:	:	:
Red(1)	1	1	1	1	1	0	0	0	0	0	0	0	0	0	0	0	0	0	
Red(0)	1	1	1	1	1	1	0	0	0	0	0	0	0	0	0	0	0	0	
Green	Black	0	0	0	0	0	0	0	0	0	0	0	0	0	0	0	0	0	0
	Green(62)	0	0	0	0	0	0	0	0	0	0	0	1	0	0	0	0	0	0
	Green(61)	0	0	0	0	0	0	0	0	0	0	1	0	0	0	0	0	0	0
	:	:	:	:	:	:	:	:	:	:	:	:	:	:	:	:	:	:	:
	Green(31)	0	0	0	0	0	0	0	1	1	1	1	0	0	0	0	0	0	0
	:	:	:	:	:	:	:	:	:	:	:	:	:	:	:	:	:	:	:
Green(1)	0	0	0	0	0	0	1	1	1	1	1	0	0	0	0	0	0	0	
Green(0)	0	0	0	0	0	0	1	1	1	1	1	1	0	0	0	0	0	0	
Blue	Black	0	0	0	0	0	0	0	0	0	0	0	0	0	0	0	0	0	0
	Blue(62)	0	0	0	0	0	0	0	0	0	0	0	0	0	0	0	0	0	1
	Blue(61)	0	0	0	0	0	0	0	0	0	0	0	0	0	0	0	0	0	1
	:	:	:	:	:	:	:	:	:	:	:	:	:	:	:	:	:	:	:
	Blue(31)	0	0	0	0	0	0	0	0	0	0	0	0	0	1	1	1	1	1
	:	:	:	:	:	:	:	:	:	:	:	:	:	:	:	:	:	:	:
Blue(1)	0	0	0	0	0	0	0	0	0	0	0	0	1	1	1	1	1	0	
Blue(0)	0	0	0	0	0	0	0	0	0	0	0	0	1	1	1	1	1	1	

11 QUALITY AND RELIABILITY

11.1 TEST CONDITIONS

Tests should be conducted under the following conditions :

Ambient temperature : $25 \pm 5^{\circ}\text{C}$

Humidity : $60 \pm 25\% \text{ RH}$.

11.2 SAMPLING PLAN

Sampling method shall be in accordance with MIL-STD-105E , level II, normal single sampling plan .

11.3 ACCEPTABLE QUALITY LEVEL

A major defect is defined as one that could cause failure to or materially reduce the usability of the unit for its intended purpose. A minor defect is one that does not materially reduce the usability of the unit for its intended purpose or is an infringement from established standards and has no significant bearing on its effective use or operation.

11.4 APPEARANCE

An appearance test should be conducted by human sight at approximately 30 cm distance from the LCD module under fluorescent light. The inspection area of LCD panel shall be within the range of following limits.

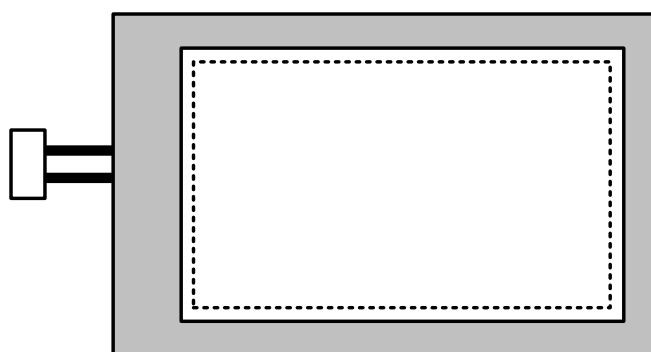

⋯ Zone A (Active Area)

□ Zone B (Viewing Area)

11.5 INSPECTION QUALITY CRITERIA

Defect Type			Limit			Note		
Visual Defect	Internal	Spot	$\phi < 0.15\text{mm}$		Ignore	(1)		
			$0.15\text{mm} \leq \phi \leq 0.5\text{mm}$		$N \leq 4$			
			$0.5\text{mm} < \phi$		$N=0$			
		Fiber	$0.03\text{mm} < W \leq 0.1\text{mm},$ $L \leq 5\text{mm}$		$N \leq 3$	(1)		
			$1.0\text{mm} < W, 1.5\text{mm} < L$		$N=0$			
		Polarizer Bubble	$\phi < 0.15\text{mm}$		Ignore	(1)		
			$0.15\text{mm} \leq \phi \leq 0.5\text{mm}$		$N \leq 2$			
			$0.5\text{mm} < \phi$		$N=0$			
		Mura	It' OK if mura is slight visible through 6%ND filter					
Electrical Defect	Bright Dot	A Grade			B Grade			
		C Area	O Area	Total	C Area	O Area	Total	(3)
		$N \leq 0$	$N \leq 2$	$N \leq 2$	$N \leq 2$	$N \leq 3$	$N \leq 5$	(2)
	Dark Dot	$N \leq 2$	$N \leq 3$	$N \leq 3$	$N \leq 3$	$N \leq 5$	$N \leq 8$	
	Total Dot	$N \leq 4$			$N \leq 5$	$N \leq 6$	$N \leq 8$	(2)
	Two Adjacent Dot	$N \leq 0$	$N \leq 1$ pair	$N \leq 1$ pair	$N \leq 1$ pair	$N \leq 1$ pair	$N \leq 1$ pair	(4)
	Three or More Adjacent Dot	Not Allowed						
	Line Defect	Not Allowed						

[Note1] W : Width[mm], L : Length[mm], N : Number, ϕ : Average Diameter

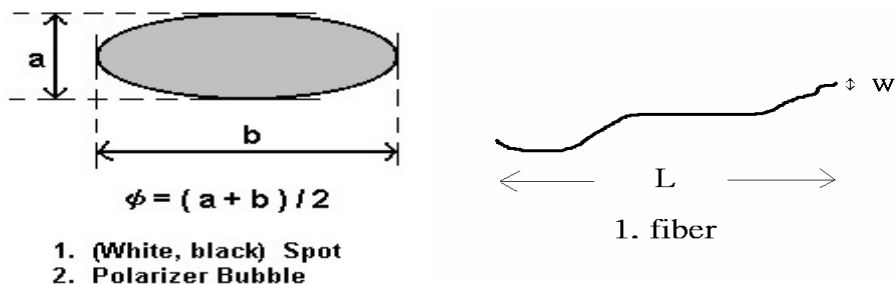

[Note2] Bright dot is defined through 6% transmission ND Filter as following.

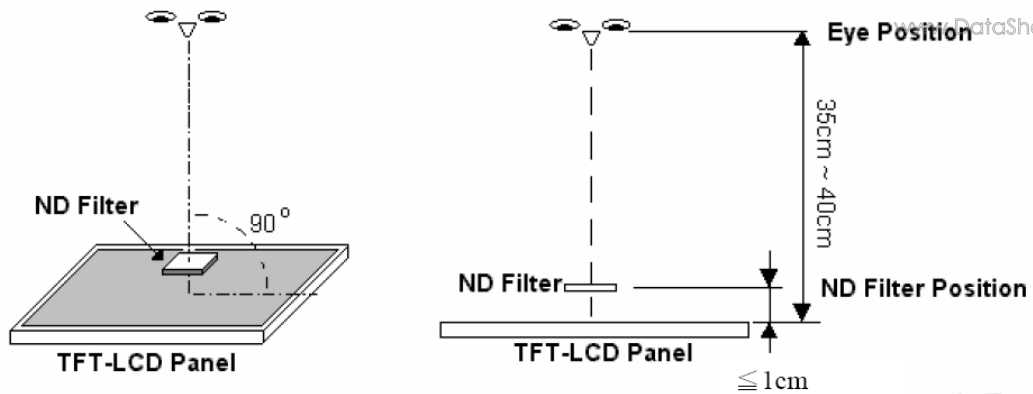

[Note3]

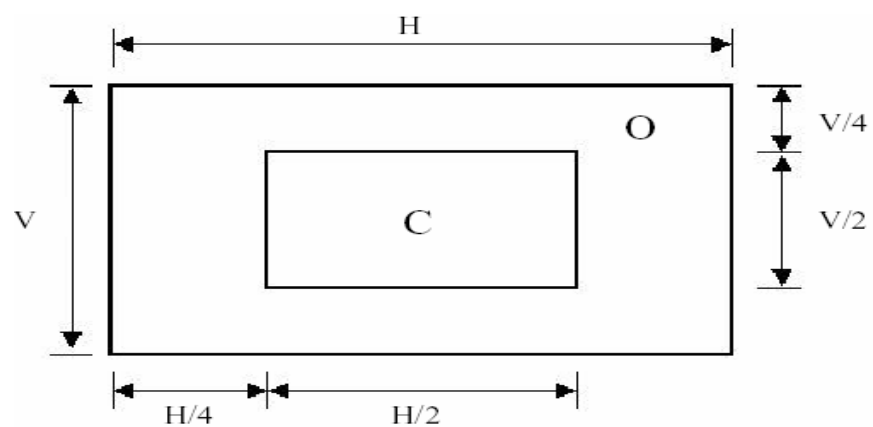

C Area: Center of display area
C Area: Outer of display area

[Note4]

Judge defect dot and adjacent dot as following. Allow below (as A, B, C and D status) adjacent defect dots, including bright and dart adjacent dot. And they will be counted 2 defect dots in total quantity.

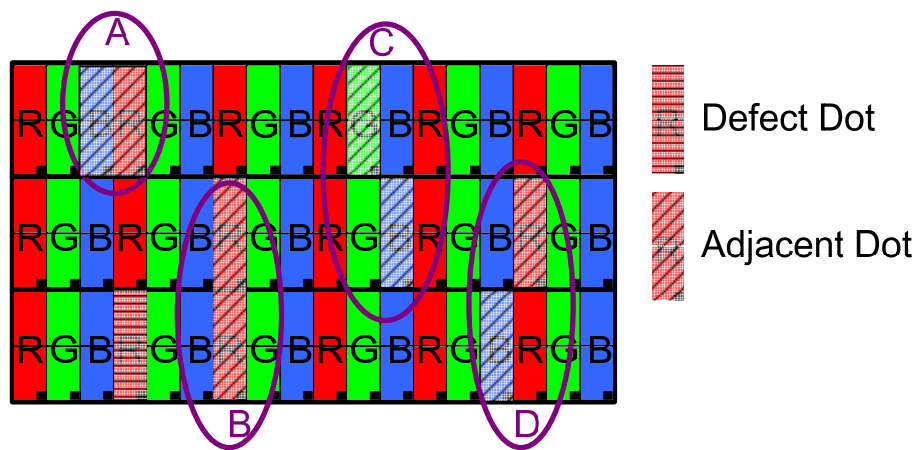

- (1) The defects that are not defined above and considered to be problem shall be reviewed and discussed by both parties.
- (2) Defects on the Black Matrix, out of Display area, are not considered as a defect or counted.

Reliability test items :

Test Item	Test Conditions	Note
High Temperature Operation	70±3°C , t=96 hrs	
Low Temperature Operation	-20±3°C , t=96 hrs	
High Temperature Storage	80±3°C , t=96 hrs	1,2
Low Temperature Storage	-30±3°C , t=96 hrs	1,2
Humidity Test	40°C , Humidity 90%, 96 hrs	1,2
Thermal Shock Test	-30°C ~ 25°C ~ 80°C 30 min. 5 min. 30 min. (1 cycle) Total 5 cycle	1,2
Vibration Test (Packing)	Sweep frequency : 10~55~10 Hz/1min Amplitude : 0.75mm Test direction : X.Y.Z/3 axis Duration : 30min/each axis	2
Static Electricity	150pF 330 ohm ±8kV, 10times air discharge 150pF 330 ohm ±4kV, 10times contact discharge	

Note 1 : Condensation of water is not permitted on the module.

Note 2 : The module should be inspected after 1 hour storage in normal conditions

(15-35°C , 45-65%RH).

Definitions of life end point :

- Current drain should be smaller than the specific value.
- Function of the module should be maintained.
- Appearance and display quality should not have degraded noticeably.
- Contrast ratio should be greater than 50% of the initial value.

12 USE PRECAUTIONS

12.1 Handling precautions

- 1) The polarizing plate may break easily so be careful when handling it. Do not touch, press or rub it with a hard-material tool like tweezers.
- 2) Do not touch the polarizing plate surface with bare hands so as not to make it dirty. If the surface or other related part of the polarizing plate is dirty, soak a soft cotton cloth or chamois leather in benzine and wipe off with it. Do not use chemical liquids such as acetone, toluene and isopropyl alcohol. Failure to do so may bring chemical reaction phenomena and deteriorations.
- 3) Remove any spit or water immediately. If it is left for hours, the suffered part may deform or decolorize.
- 4) If the LCD element breaks and any LC stuff leaks, do not suck or lick it. Also if LC stuff is stuck on your skin or clothing, wash thoroughly with soap and water immediately.

12.2 Installing precautions

- 1) The PCB has many ICs that may be damaged easily by static electricity. To prevent breaking by static electricity from the human body and clothing, earth the human body properly using the high resistance and discharge static electricity during the operation. In this case, however, the resistance value should be approx. $1M\Omega$ and the resistance should be placed near the human body rather than the ground surface. When the indoor space is dry, static electricity may occur easily so be careful. We recommend the indoor space should be kept with humidity of 60% or more. When a soldering iron or other similar tool is used for assembly, be sure to earth it.
- 2) When installing the module and ICs, do not bend or twist them. Failure to do so may crack LC element and cause circuit failure.
- 3) To protect LC element, especially polarizing plate, use a transparent protective plate (e.g., acrylic plate, glass etc) for the product case.
- 4) Do not use an adhesive like a both-side adhesive tape to make LCD surface (polarizing plate) and product case stick together. Failure to do so may cause the polarizing plate to peel off.

12.3 Storage precautions

- 1) Avoid a high temperature and humidity area. Keep the temperature between 0°C and 35°C and also the humidity under 60%.
- 2) Choose the dark spaces where the product is not exposed to direct sunlight or fluorescent light.
- 3) Store the products as they are put in the boxes provided from us or in the same conditions as we recommend.

12.4 Operating precautions

- 1) Do not boost the applied drive voltage abnormally. Failure to do so may break ICs. When applying power voltage, check the electrical features beforehand and be careful. Always turn off the power to the LC module controller before removing or inserting the LC module input connector. If the input connector is removed or inserted while the power is turned on, the LC module internal circuit may break.
- 2) The display response may be late if the operating temperature is under the normal standard, and the display may be out of order if it is above the normal standard. But this is not a failure; this will be restored if it is within the normal standard.
- 3) The LCD contrast varies depending on the visual angle, ambient temperature, power voltage etc. Obtain the optimum contrast by adjusting the LC drive voltage.
- 4) When carrying out the test, do not take the module out of the low-temperature space suddenly. Failure to do so will cause the module condensing, leading to malfunctions.
- 5) Make certain that each signal noise level is within the standard (L level: 0.2V_{dd} or less and H level: 0.8V_{dd} or more) even if the module has functioned properly. If it is beyond the standard, the module may often malfunction. In addition, always connect the module when making noise level measurements.
- 6) The CMOS ICs are incorporated in the module and the pull-up and pull-down function is not adopted for the input so avoid putting the input signal open while the power is ON.
- 7) The characteristic of the semiconductor element changes when it is exposed to light emissions, therefore ICs on the LCD may malfunction if they receive light emissions. To prevent these malfunctions, design and assemble ICs so that they are shielded from light emissions.
- 8) Crosstalk occurs because of characteristics of the LCD. In general, crosstalk occurs when the regularized display is maintained. Also, crosstalk is affected

by the LC drive voltage. Design the contents of the display, considering crosstalk. www.DataSheet4U.com

12.5 Other

- 1) Do not disassemble or take the LC module into pieces. The LC modules once disassembled or taken into pieces are not the guarantee articles.
- 2) The residual image may exist if the same display pattern is shown for hours. This residual image, however, disappears when another display pattern is shown or the drive is interrupted and left for a while. But this is not a problem on reliability.
- 3) AMIPRE will provide one year warranty for all products and three months warranty for all repairing products.

13 OUTLINE DIMENSION

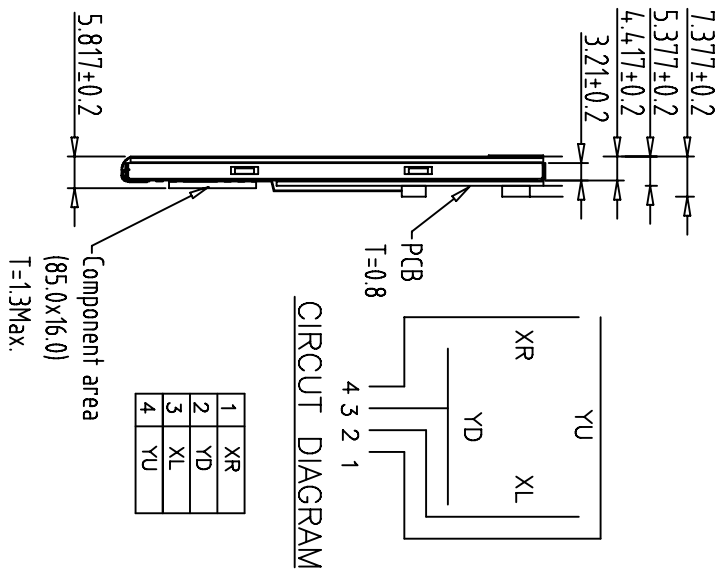
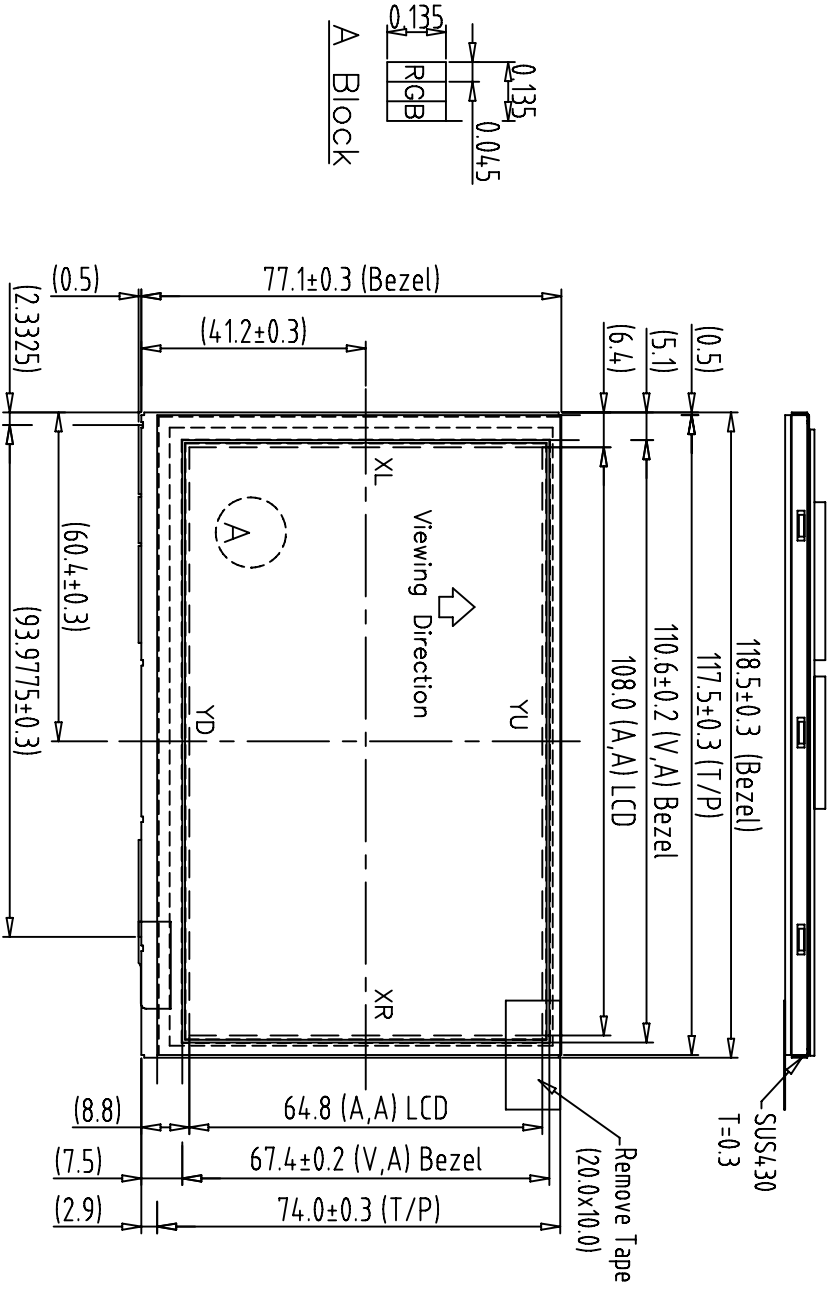

REV	REVISION RECORD	DATE	NAME
0	NEW RELEASE	11-23-09	SNOW

- Note:
1. Unless indicated, Tolerance Grade "B" is adopted.
 2. UV Glue For OLB Protection.
 3. LCD 800x480 (R,G,B) TFT LCD => 800480L (5.0") TFT LCD

NO.	ITEM	QTY	TOLERANCE GRADE(F)	A	B	DIK.	MM	DWN.	SNOW	DATE
1		7	~6	0.05	0.1			CHK.		11-23-09
2		8	~6	0.08	0.18	IE NO.				
3		9	18~50	0.1	0.25					
4		10	50~180	0.2	0.4	PARTS NO. LCM				
5		11	180~	0.3	0.5	800480L-TWO				
6		12								

晶采光电科技
800480L-TWO
 (5.0")
 DWG. NO. *O91167MA SHEET 1 OF 1