

Product Features

- DC – 6000 MHz
- +18 dBm P1dB at 900 MHz
- +31.5 dBm OIP3 at 900 MHz
- 20.5 dB Gain at 900 MHz
- Single Voltage Supply
- Green SOT-86 SMT Package
- Internally matched to 50 Ω

Applications

- Mobile Infrastructure
- CATV / DBS
- W-LAN / ISM
- RFID
- Defense / Homeland Security
- Fixed Wireless

Product Description

The AG403-86 is a general-purpose buffer amplifier that offers high dynamic range in a low-cost surface-mount package. At 900 MHz, the AG403-86 typically provides 20.5 dB gain, +31.5 dBm OIP3, and +18 dBm P1dB. The device combines dependable performance with consistent quality to maintain MTTF values exceeding 100 years at mounting temperatures of +85 °C & is housed in a SOT-86 industry-standard SMT lead-free/green/RoHS-compliant package.

The AG403-86 consists of Darlington pair amplifiers using the high reliability InGaP/GaAs HBT process technology and only requires DC-blocking capacitors, a bias resistor, and an inductive RF choke for operation.

The broadband MMIC amplifier can be directly applied to various current and next generation wireless technologies such as GPRS, GSM, CDMA, and W-CDMA. In addition, the AG403-86 will work for other various applications within the DC to 6 GHz frequency range such as CATV and fixed wireless.

Functional Diagram

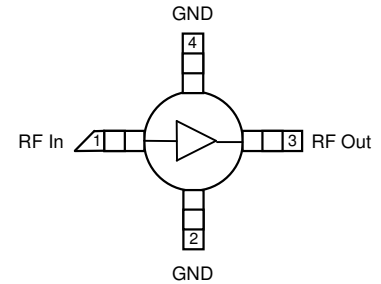

Function	Pin No.
Input	1
Output/Bias	3
Ground	2, 4

Specifications ⁽¹⁾

Parameter	Units	Min	Typ	Max
Operational Bandwidth	MHz	DC		6000
Test Frequency	MHz		900	
Gain	dB		20.3	
Input Return Loss	dB		19	
Output Return Loss	dB		21	
Output IP3 ⁽²⁾	dBm		+31.4	
Output IP2	dBm		+44	
Output P1dB	dBm		+17.8	
Noise Figure	dB		3.0	
Test Frequency	MHz		1900	
Gain	dB	17.1	18.1	19.1
Output IP3 ⁽²⁾	dBm		+28.5	
Output P1dB	dBm		+16.0	
Device Voltage	V		4.91	
Device Current	mA		60	

1. Test conditions: T = 25° C, Supply Voltage = +6 V, R_{bias} = 18.2 Ω, 50 Ω System.
2. 3OIP measured with two tones at an output power of 0 dBm/tone separated by 10 MHz. The suppression on the largest IM3 product is used to calculate the 3OIP using a 2:1 rule.
3. The junction temperature ensures a minimum MTTF rating of 1 million hours of usage.

Absolute Maximum Rating

Parameter	Rating
Operating Case Temperature	-40 to +85 °C
Storage Temperature	-55 to +125 °C
DC Voltage	+6.2 V
RF Input Power (continuous)	+10 dBm
Junction Temperature	+250° C

Operation of this device above any of these parameters may cause permanent damage.

Typical Performance ⁽¹⁾

Parameter	Units	Typical			
Frequency	MHz	500	900	1900	2140
S21	dB	21.0	20.3	18.1	17.5
S11	dB	-18	-19	-19	-19
S22	dB	-25	-21	-15	-13
Output P1dB	dBm	+17.8	+17.8	+16.0	+15.2
Output IP3	dBm	+32.6	+31.4	+28.5	+27.7
Noise Figure	dB	3.0	3.0	3.1	3.2

Ordering Information

Part No.	Description
AG403-86	InGaP HBT Gain Block (lead-tin SOT-86 Pkg)
AG403-86G	InGaP HBT Gain Block (lead-free/green/RoHS-compliant SOT-86 Pkg)
AG403-86PCB	700 – 2400 MHz Fully Assembled Eval. Board

Typical Device RF Performance

Supply Bias = 6 V, $R_{bias} = 18.2 \Omega$, $I_{cc} = 60 \text{ mA}$

Frequency	MHz	100	500	900	1900	2140	2400	3500	5800
S21	dB	21.3	21.0	20.3	18.1	17.5	16.9	15.0	11.6
S11	dB	-20	-18	-19	-19	-19	-19	-19	-21
S22	dB	-21	-25	-21	-15	-13	-13	-16	-13
Output P1dB	dBm	+17.8	+17.8	+17.8	+16.0	+15.2	+14.6	+11.5	
Output IP3	dBm	+33.0	+32.6	+31.4	+28.5	+27.7	+26.9		
Noise Figure	dB	2.9	3.0	3.0	3.1	3.2	3.3		

1. Test conditions: $T = 25^\circ \text{C}$, Supply Voltage = +6 V, Device Voltage = 4.91 V, $R_{bias} = 18.2 \Omega$, $I_{cc} = 60 \text{ mA}$ typical, 50Ω System.
2. 3OIP measured with two tones at an output power of 0 dBm/tones separated by 10 MHz. The suppression on the largest IM3 product is used to calculate the 3OIP using a 2:1 rule.
3. Data is shown as device performance only. Actual implementation for the desired frequency band will be determined by external components shown in the application circuit.

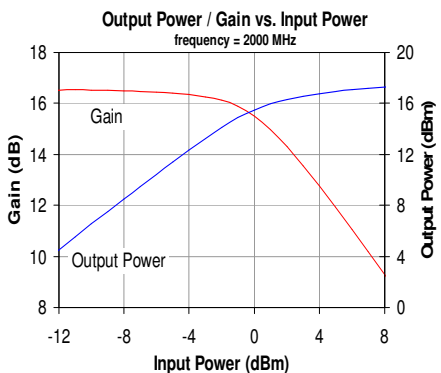
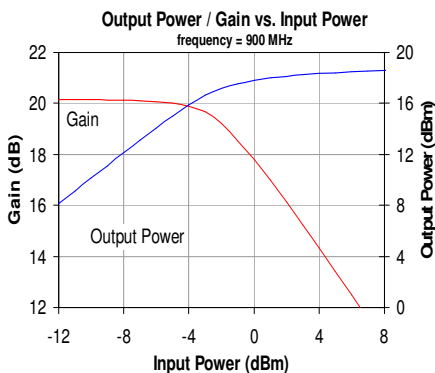
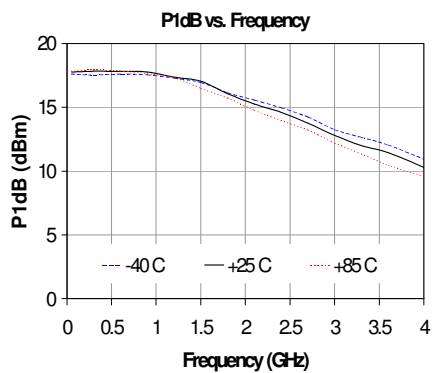
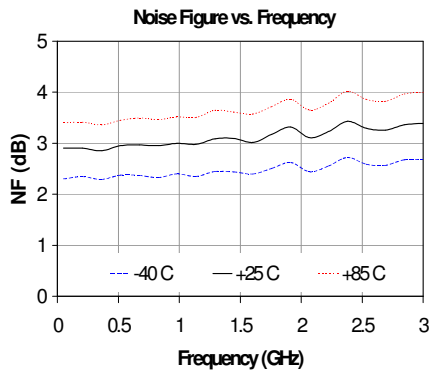
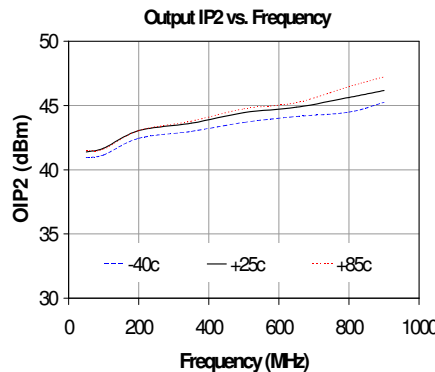
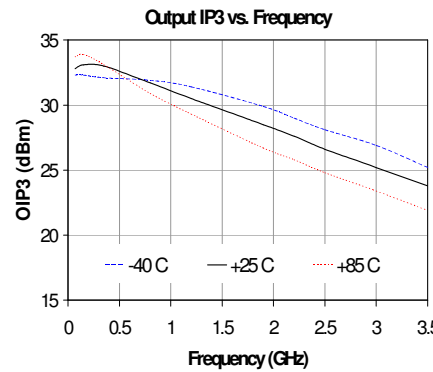
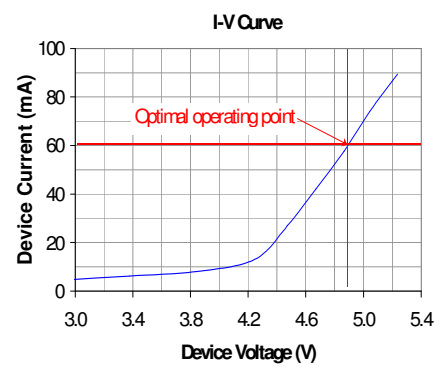
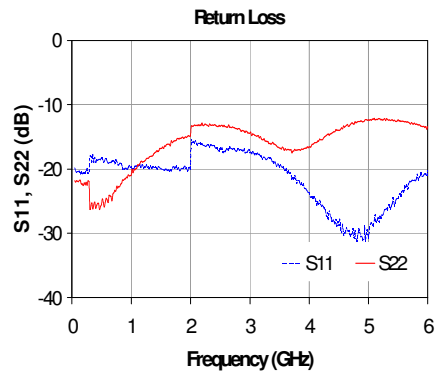
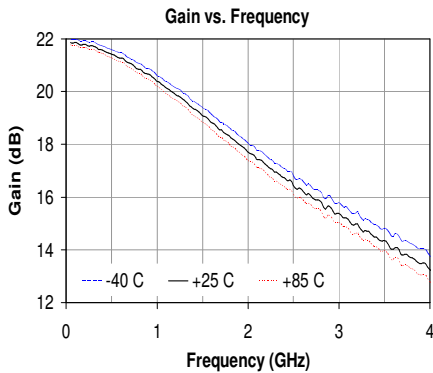

Typical Device RF Performance (cont'd)

Supply Bias = +8 V, $R_{bias} = 51 \Omega$, $I_{cc} = 60 \text{ mA}$

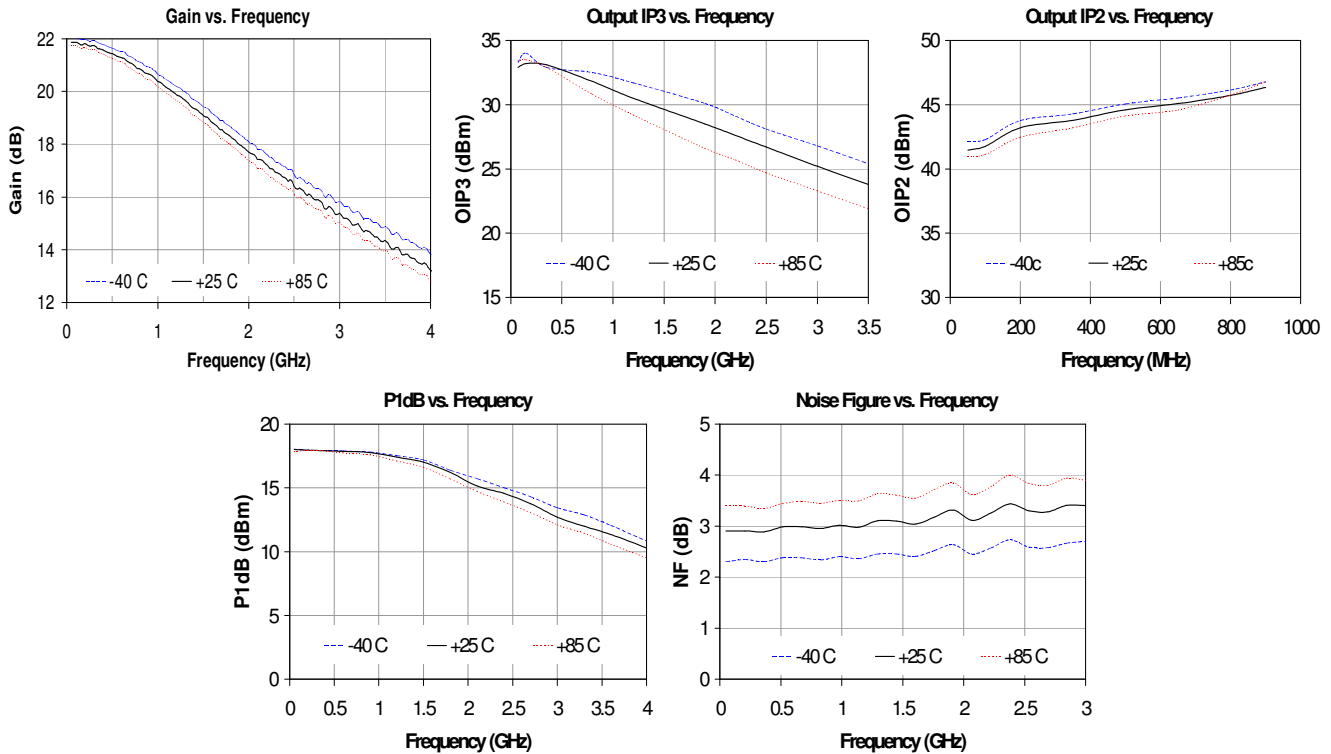

Application Circuit

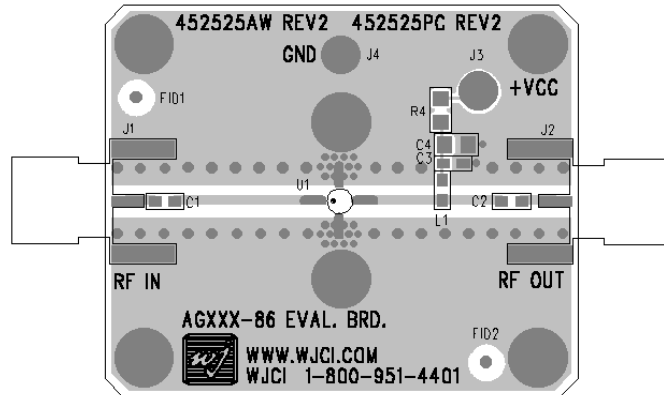
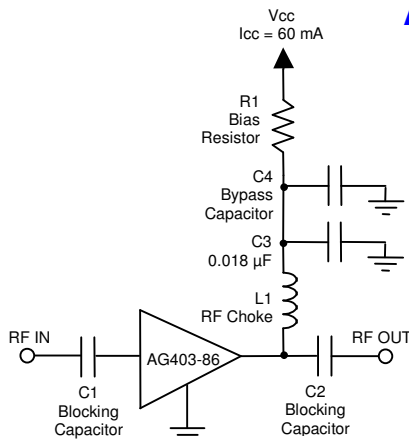

Recommended Component Values

Reference Designator	Frequency (MHz)						
	50	500	900	1900	2200	2500	3500
L1	820 nH	220 nH	68 nH	27 nH	22 nH	18 nH	15 nH
C1, C2, C4	.018 μF	1000 pF	100 pF	68 pF	68 pF	56 pF	39 pF

- The proper values for the components are dependent upon the intended frequency of operation.
- The following values are contained on the evaluation board to achieve optimal broadband performance:

Ref. Desig.	Value / Type	Size
L1	39 nH wirewound inductor	0603
C1, C2	56 pF chip capacitor	0603
C3	0.018 μF chip capacitor	0603
C4	Do Not Place	
R1	18.2 Ω 1% tolerance	0805

Recommended Bias Resistor Values

Supply Voltage	R1 value	Size
6 V	18.2 ohms	0805
7 V	34.8 ohms	1206
8 V	52 ohms	1210
9 V	68 ohms	1210
10 V	85 ohms	2010
12 V	118 ohms	2010

The proper value for R1 is dependent upon the supply voltage and allows for bias stability over temperature. WJ recommends a minimum supply bias of +6 V. A 1% tolerance resistor is recommended.

Specifications and information are subject to change without notice



Typical Device Data

S-Parameters ($V_{device} = +4.91$ V, $I_{CC} = 60$ mA, $T = 25^\circ$ C, calibrated to device leads)

Freq (MHz)	S11 (dB)	S11 (ang)	S21 (dB)	S21 (ang)	S12 (dB)	S12 (ang)	S22 (dB)	S22 (ang)
50	-19.96	178.96	21.80	177.11	-24.27	1.37	-21.87	-8.56
250	-20.03	161.79	21.67	166.40	-24.86	2.67	-22.38	-23.27
500	-18.29	144.41	21.43	153.03	-24.84	0.41	-25.34	-67.32
750	-18.69	125.75	21.04	140.39	-24.79	-1.97	-22.92	-96.88
1000	-19.75	103.57	20.57	128.52	-25.10	-3.56	-20.80	-115.67
1250	-19.49	85.86	20.05	117.01	-24.53	-2.87	-18.46	-127.17
1500	-19.96	65.61	19.46	106.46	-24.66	-1.05	-16.81	-135.05
1750	-19.67	44.52	18.86	96.58	-24.31	-3.28	-15.57	-140.07
2000	-19.19	25.46	18.23	87.12	-24.23	-1.86	-14.70	-145.08
2250	-16.47	9.39	17.63	78.94	-23.83	-5.82	-13.06	-133.83
2500	-16.76	-2.54	17.22	72.76	-24.03	-9.32	-13.34	-139.51
2750	-17.06	-12.50	16.73	64.27	-23.16	-8.40	-13.64	-145.79
3000	-17.44	-20.94	16.26	56.10	-23.28	-7.63	-14.45	-155.77
3250	-18.26	-28.52	15.82	48.49	-22.60	-9.15	-15.52	-165.77
3500	-19.67	-36.75	15.40	40.73	-22.73	-9.59	-16.75	176.91
3750	-21.24	-39.96	14.96	33.05	-22.14	-14.85	-17.04	153.24
4000	-23.74	-40.60	14.54	25.39	-21.60	-16.87	-16.55	133.43
4250	-26.07	-43.48	14.15	18.04	-21.30	-19.30	-15.11	117.23
4500	-28.72	-35.53	13.71	10.72	-20.86	-23.27	-13.98	107.90
4750	-30.07	-39.18	13.29	3.34	-20.83	-24.94	-13.01	104.62
5000	-30.66	-46.11	12.94	-3.45	-20.32	-28.30	-12.36	104.65
5250	-26.93	-62.38	12.57	-10.07	-20.17	-31.73	-12.34	104.43
5500	-24.53	-76.41	12.21	-16.59	-19.91	-33.92	-12.35	107.24
5750	-21.76	-89.71	11.99	-23.09	-19.75	-37.97	-12.98	112.15
6000	-20.29	-92.71	11.73	-29.36	-19.15	-42.19	-13.43	113.78

Device S-parameters are available for download off of the website at: <http://www.wj.com>

AG403-86 (SOT-86 Package) Mechanical Information

This package may contain lead-bearing materials. The plating material on the leads is SnPb.

Outline Drawing

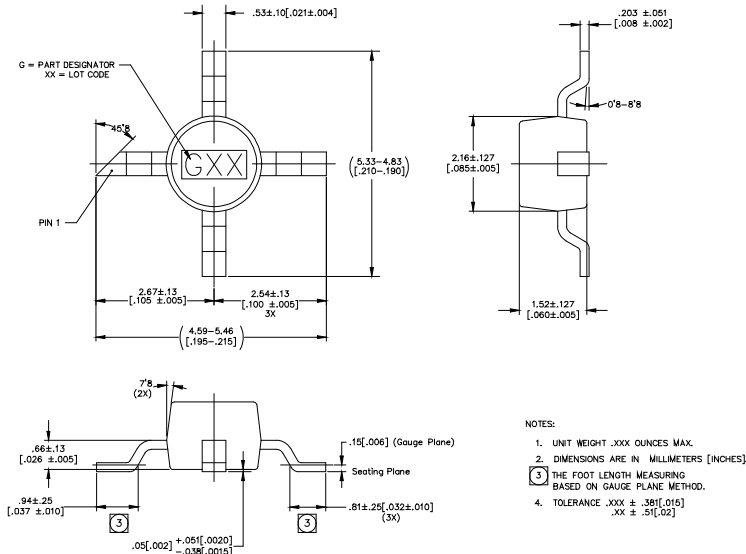

Land Pattern

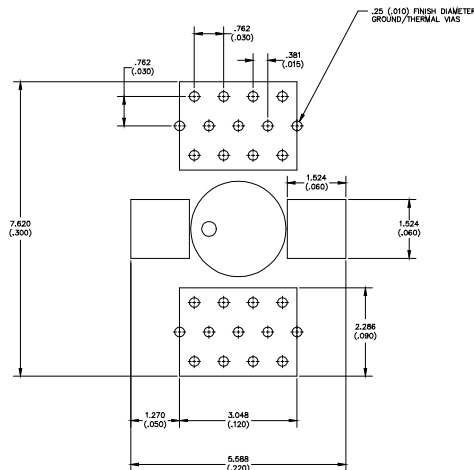

Thermal Specifications

Parameter	Rating
Operating Case Temperature	-40 to +85 °C
Thermal Resistance, Rth ⁽¹⁾	233 °C/W
Junction Temperature, Tj ⁽²⁾	143 °C

- The thermal resistance is referenced from the hottest part of the junction to the ground lead (pin 2 or 4).
- This corresponds to the typical biasing condition of +4.91V, 60 mA at an 85 °C case temperature. A minimum MTTF of 1 million hours is achieved for junction temperatures below 177 °C.

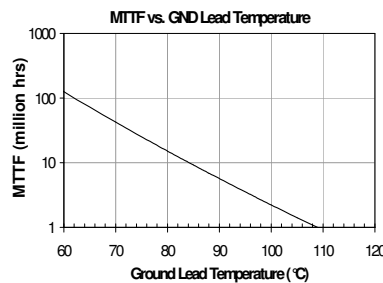

Product Marking

The component will be marked with a “G” designator followed by a two-digit numeric lot code on the top surface of the package.

Tape and reel specifications for this part are located on the website in the “Application Notes” section.

MSL / ESD Rating



Caution! ESD sensitive device.

ESD Rating: Class 0
 Value: Passes at 150 V
 Test: Human Body Model (HBM)
 Standard: JEDEC Standard JESD22-A114

ESD Rating: Class II
 Value: Passes at 250 V
 Test: Charged Device Model (CDM)
 Standard: JEDEC Standard JESD22-C101

MSL Rating: Level 1
 Standard: JEDEC Standard J-STD-020A

Mounting Config. Notes

- Ground / thermal vias are critical for the proper performance of this device. Vias should use a .35mm (#80 / .0135”) diameter drill and have a final plated thru diameter of .25mm (.010”).
- Add as much copper as possible to inner and outer layers near the part to ensure optimal thermal performance.
- Mounting screws can be added near the part to fasten the board to a heatsink. Ensure that the ground / thermal via region contacts the heatsink.
- Do not put solder mask on the backside of the PC board in the region where the board contacts the heatsink.
- RF trace width depends upon the PC board material and construction.
- Use 1 oz. Copper minimum.
- All dimensions are in millimeters (inches). Angles are in degrees.

AG403-86G (Green / Lead-free Sot-86 Package) Mechanical Information

This package is lead-free/Green/RoHS-compliant. It is compatible with both lead-free (maximum 260°C reflow temperature) and leaded (maximum 245°C reflow temperature) soldering processes. The plating material on the pins is annealed matte tin over copper.

Outline Drawing

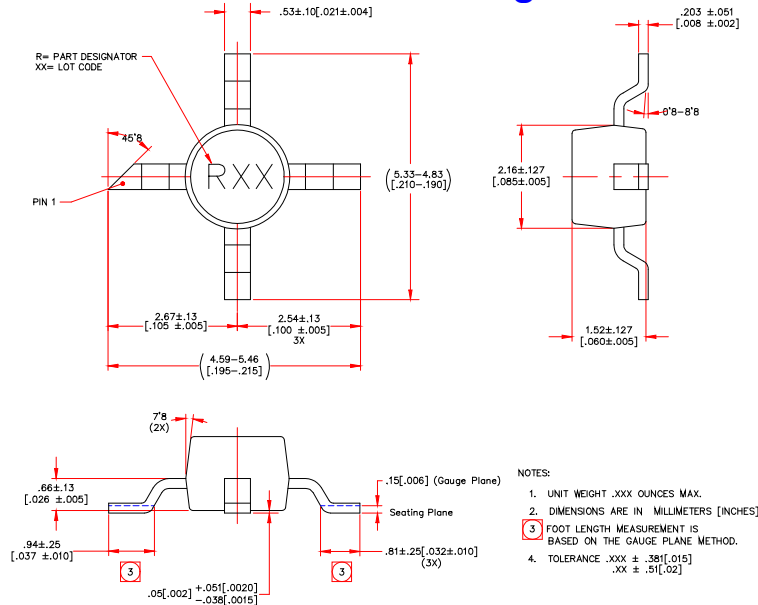

Land Pattern

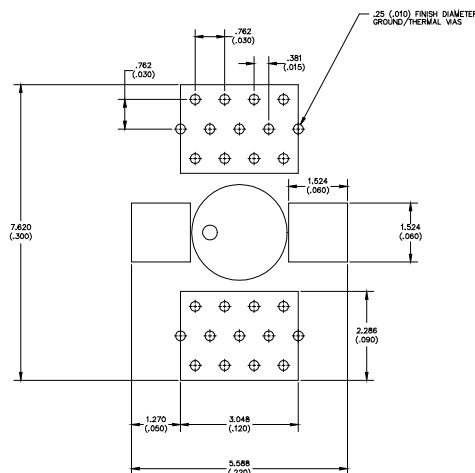

Product Marking

The component will be marked with an “R” designator followed by a two-digit numeric lot code on the top surface of the package.

Tape and reel specifications for this part are located on the website in the “Application Notes” section.

MSL / ESD Rating



Caution! ESD sensitive device.

ESD Rating: Class 1C
 Value: Passes at 1000 V min.
 Test: Human Body Model (HBM)
 Standard: JEDEC Standard JESD22-A114

ESD Rating: Class IV
 Value: Passes at 1000 V min.
 Test: Charged Device Model (CDM)
 Standard: JEDEC Standard JESD22-C101

MSL Rating: Level 3 at +260° C convection reflow
 Standard: JEDEC Standard J-STD-020

Mounting Config. Notes

- Ground / thermal vias are critical for the proper performance of this device. Vias should use a .35mm (#80 / .0135”) diameter drill and have a final plated thru diameter of .25mm (.010”).
- Add as much copper as possible to inner and outer layers near the part to ensure optimal thermal performance.
- Mounting screws can be added near the part to fasten the board to a heatsink. Ensure that the ground / thermal via region contacts the heatsink.
- Do not put solder mask on the backside of the PC board in the region where the board contacts the heatsink.
- RF trace width depends upon the PC board material and construction.
- Use 1 oz. Copper minimum.
- All dimensions are in millimeters (inches). Angles are in degrees.

Thermal Specifications

Parameter	Rating
Operating Case Temperature	-40 to +85 °C
Thermal Resistance, Rth ⁽¹⁾	233 °C/W
Junction Temperature, Tjc ⁽²⁾	154 °C

- The thermal resistance is referenced from the hottest part of the junction to the ground lead (pin 2 or 4).
- This corresponds to the typical biasing condition of +4.91V, 60 mA at an 85 °C case temperature. A minimum MTTF of 1 million hours is achieved for junction temperatures below 177 °C.

