

ADJD-MJ50 / ADJD-MJ51 and ADJD-MJ60 / ADJD-MJ61

High Performance RGB LED Light Source

Data Sheet



Lead (Pb) Free
RoHS 6 fully
compliant

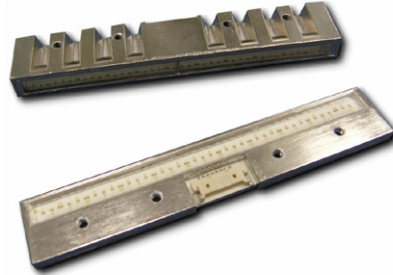

Description

Avago RGB LED Light Source is a high performance device which can be operated at high driving current. It comes with a plug-and-play electrical connector.

The built-in heat sink and the mechanical mounting features simplify the thermal management of a lighting solution. This enables effective heat transfer and maintain LED junction below maximum allowed temperature.

The footprint of the top emitting package is 100mm x 18mm x 3.6mm with aperture of 96mm x 6mm. The footprint of side emitting package is 100mm x 18mm x 8mm with aperture of 96mm x 4.6mm.

The reflector cavity design maximized the light extraction as well as maximized the color mixing to produce the required color. Together with closely pitched LED dice, the color mixing is best of its class.

Features

- High flux output
- Choice of top emitting or side emitting
- Compact footprint for ease of stacking horizontally and vertically.
- Integrated heatsink to simplify thermal management
- Red, Green & Blue color premix in the reflector cavity to produce required color
- Silicone encapsulation for extra long product life
- Plug and play mechanical mounting and electrical connection (connector interface)
- Fully serviceable due to ease of mounting and demounting.

Applications

- Decorative lighting
- Architectural lighting
- Specialty lighting

CAUTION: ADJD-MJ50/51 & ADJD-MJ60/61 are Class 1 ESD sensitive. Please observe appropriate precautions during handling and processing. Refer to Avago Technologies Application Note AN-1142 for additional details

Package Dimensions

ADJD-MJ50 and ADJD-MJ51 (Top Emitting)

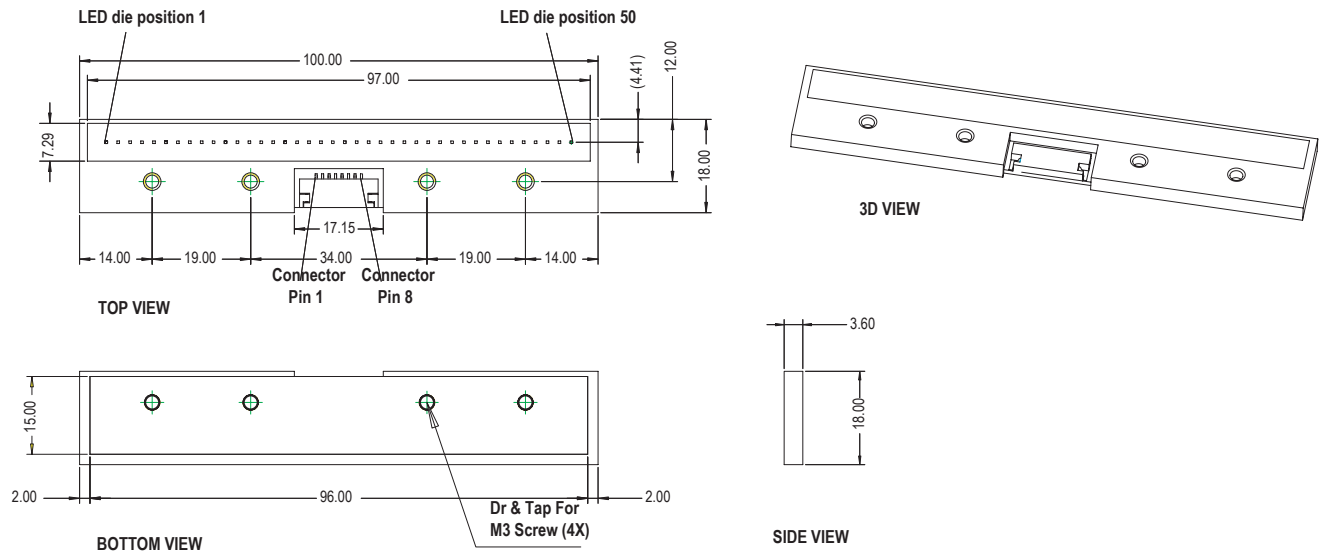

ADJD-MJ60 and ADJD-MJ61 (Side Emitting)

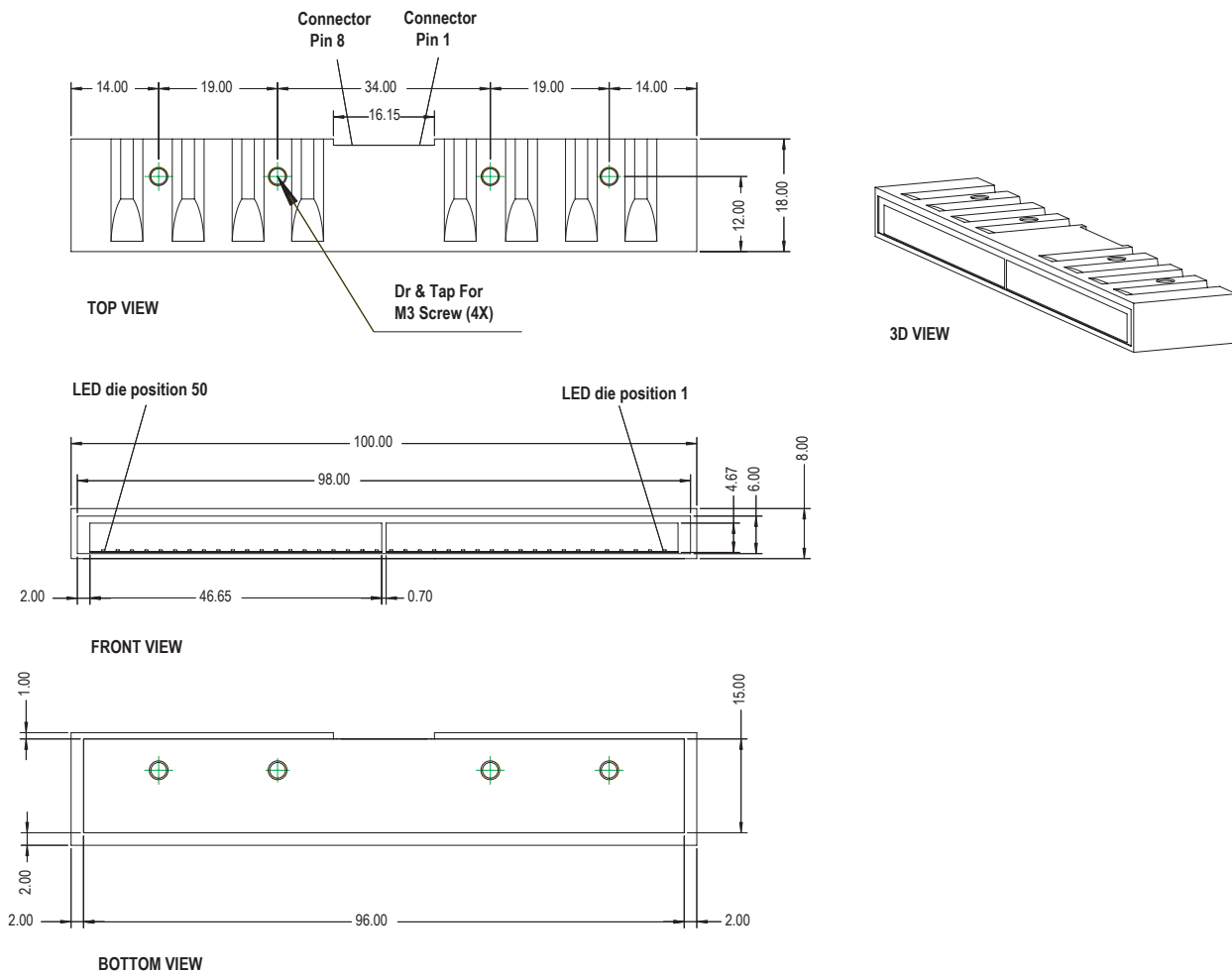

Notes:

1. All Dimensions are in millimeters.
2. Tolerance = ± 0.20 mm unless otherwise specified.

Color Configuration

Position	1	2	3	4	5	6	7	8	9	10	11	12	13	14	15	16	17	18	19	20	21	22	23	24	25	26	27	28	29	30	31	32	33	34	35	36	37	38	39	40	41	42	43	44	45	46	47	48	49	50
Color	G	B	R	R	G	G	R	R	B	G	G	R	R	B	G	G	R	R	B	G	G	R	R	B	G	G	R	R	B	G	G	R	R	B	G	G	R	R	B	G	G	R	R	B	G	G	R	R	B	G

Electrical Configuration

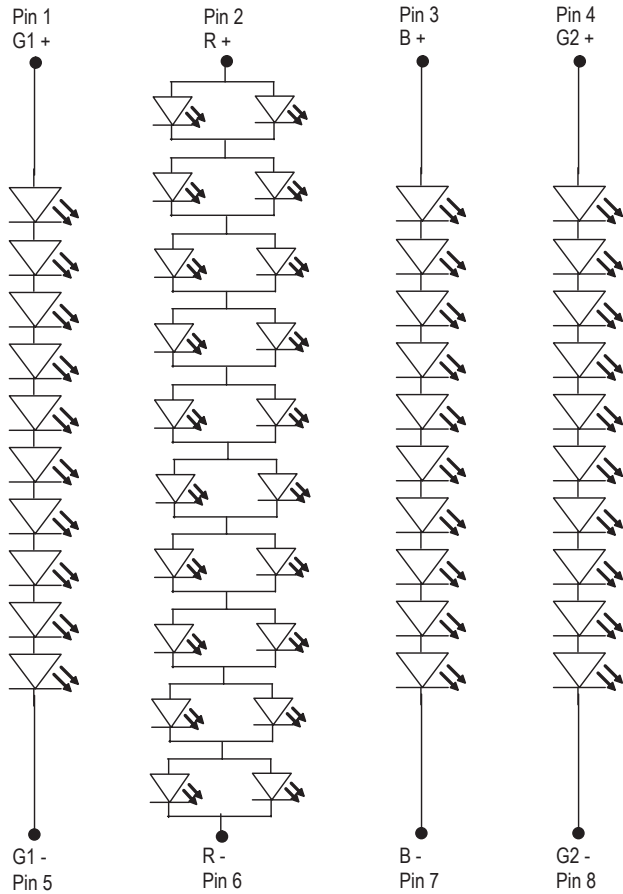

Male Connector

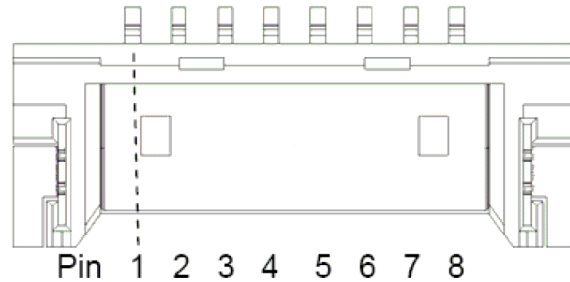

Connector and Pin Configuration

Pin Number	Configuration
1	G1 +
2	R +
3	B +
4	G2 +
5	G1 -
6	R -
7	B -
8	G2 -

Recommended female connector: Molex 51146-0800

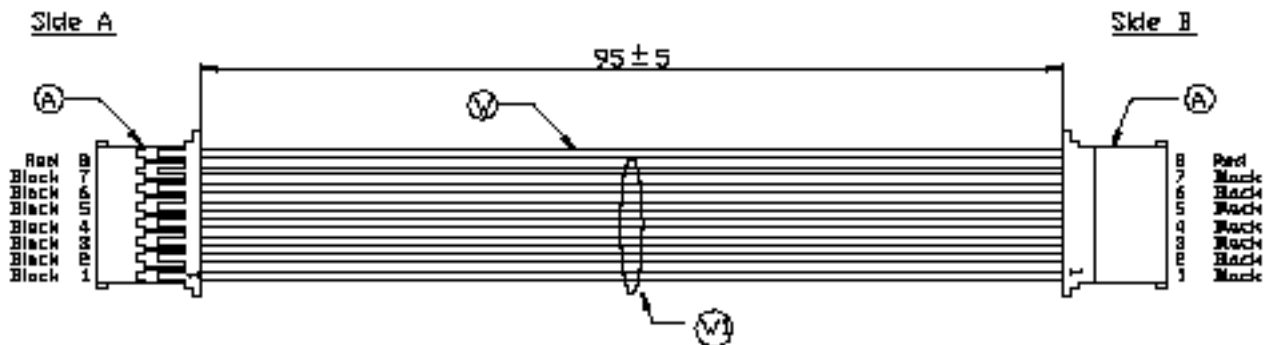

Item	Material Description	Qty	Maker / Supplier
W	Hook up wire UL1571 28AWG STR-Red	1	PIW
W1	Hook up wire UL1571 28AWG STR-Black	7	
A	Terminal : 50641-B041	16	MOLEX
	Housing : 51146-0800	2	

*Note: This cable is only applicable for ADJD-MJ51 and ADJD-MJ61

Table 1. Absolute Maximum Ratings ($T_j = 25^\circ\text{C}$)

Parameter	Red	Green & Blue	Unit
DC forward current ^{[1] [2] [3]}	300	150	mA
Power dissipation	10.5	6.75	W
Maximum junction temperature T_j max	120		$^\circ\text{C}$
Operating board temperature, T_B range ^[4]	- 40 to + 85		$^\circ\text{C}$
Storage temperature range	- 40 to + 85		$^\circ\text{C}$

Note:

1. Per individual string.
2. Derate linearly as shown in Figure 6.
3. Operation at current below 20 mA is not recommended.
4. Board temperature, T_B = temperature of the metal core PCB at the bottom of the LED.

Table 2. Electrical Characteristics ($T_j = 25^\circ\text{C}$)

Color	Forward Voltage, V_F (V) ^{[1] [2]}			Testing Current, I_F (mA) ^[1]	Dynamic Resistance, R_D (Ω) ^{[3] [4]}
	Min.	Typ.	Max.		
AllnGaP Red	25	29	35	300	26
InGaN Green G1	30	35	45	150	31
InGaN Green G2	30	35	45	150	31
InGaN Blue	30	35	45	150	31

Note:

1. Per individual string.
2. V_F tolerance is $\pm 1.0\text{V}$.
3. Measured at $T_j = 25^\circ\text{C}$, applicable from $I_F = 50\text{mA}$ onwards.
4. Dynamic resistance is the inverse slope of the forward current vs. forward voltage characteristic as in Figure 3.

Table 3. Luminous Flux

Color	Testing Current, I_F (mA)	Luminous Flux ϕ_v (lm) ^{[1] [2]} @ $T_j = 25^\circ\text{C}$		White ϕ_v at 9000K color temperature, $T_B = 70^\circ\text{C}$ ^{[3] [4] [5]} Typ.
		Min.	Typ.	
AllnGaP Red	300	130	200	310
InGaN Green G1	150	75	125	
InGaN Green G2	150	75	125	
InGaN Blue	150	12	30	

Note:

1. ϕ_v is the total luminous flux output as measured with an integrating sphere per individual string.
2. ϕ_v tolerance $\pm 15\%$.
3. White point at 9000K color temperature according to CIE 1931: (0.285, 0.300).
4. When the LEDs are tuned to 9000K color temperature at $T_B = 70^\circ\text{C}$, not all LED strings will be driven at its maximum forward current.
5. Board temperature, T_B = temperature of the metal core PCB at the bottom of the LED.

Table 4. Optical Characteristics ($T_j = 25^\circ\text{C}$)

Color	Testing Current, I_F (mA)	Chromaticity Coordinates ^[1]		Dominant Wavelength, λ_d (nm) ^[1]			Peak Wavelength, λ_p (nm)	Spectral Width at Half Max, $\Delta\lambda_{1/2}$ (nm) ^[2]
		Typ.	Typ.	Min.	Typ.	Max.	Typ.	Typ.
AllnGaP Red	300	0.684	0.315	615	617	625	626	20
InGaN Green G1	150	0.191	0.715	520	530	535	523	35
InGaN Green G2	150	0.191	0.715	520	530	535	523	35
InGaN Blue	150	0.153	0.033	450	457	460	451	24

Notes:

1. The chromaticity coordinates and dominant wavelength are derived from the CIE Chromaticity Diagram and represent the perceived color of the device.
2. The total spectral width at 1/2 of the peak intensity.

Table 5. Thermal Characteristics

Color	Temperature Coefficients	
	of Dominant Wavelength $\Delta\lambda_{dom}/\Delta T_j$ (nm/ $^\circ\text{C}$) Typ.	of Forward Voltage $\Delta V_F/\Delta T_j$ (mV/ $^\circ\text{C}$) Typ.
AllnGaP Red	0.08	-24
InGaN Green G1	0.01	-33
InGaN GreenG2	0.01	-33
InGaN Blue	0.03	-29

Table 6. Thermal Resistance (From Junction to Board)

Part Number	Thermal Resistance, Junction to Board, RO_{J-B} ^[1] ($^\circ\text{C}/\text{W}$) Typ.
ADJD-MJ50/51 and ADJD-MJ60/61	2.0

Notes:

1. Thermal resistance is defined as the increase of junction temperature with reference to T_B per 1W of total electrical power that is applied to the entire unit.
2. T_B = temperature of the metal core PCB at the bottom of the LED.

Intensity Bins

ADJD-MJ50 / 51

Bin ID	Luminous Flux ϕ_v (lm) [1]	
	Min.	Max.
A	400	520
B	520	670

ADJD-MJ60 / 61

Bin ID	Luminous Flux ϕ_v (lm) [1]	
	Min.	Max.
Z	310	400
A	400	520

Notes:

1. The luminous flux used for intensity binning is by lighting up all R, G1, G2 & B channels together at maximum rated current.
2. Bin categories are established for classification of products. Products may not be available in all categories. Please contact your Avago representative for information on current available bins.

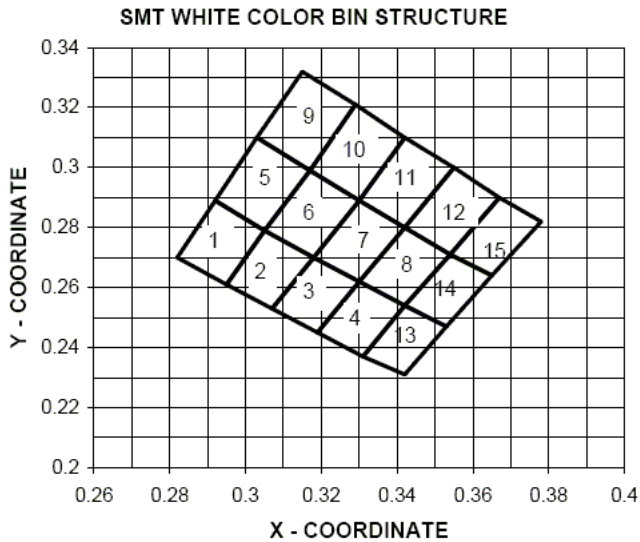

Figure 1. Color bins¹

Note:

1. The chromaticity coordinate used for binning the product is obtained when all R, G1, G2 & B channels are lighted up together at maximum rated current.
2. Bin categories are established for classification of products. Products may not be available in all categories. Please contact your Avago representative for information on current available bins.

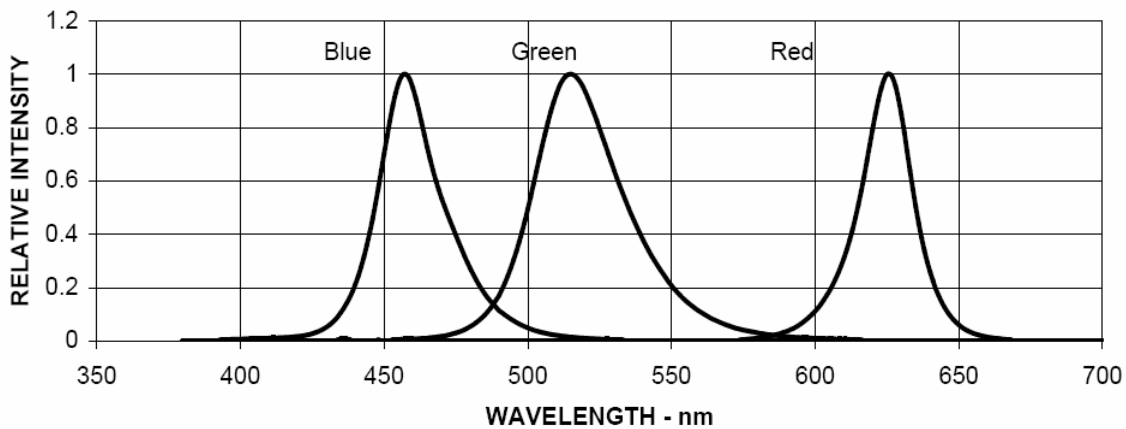

Figure 2. Relative intensity vs. wavelength

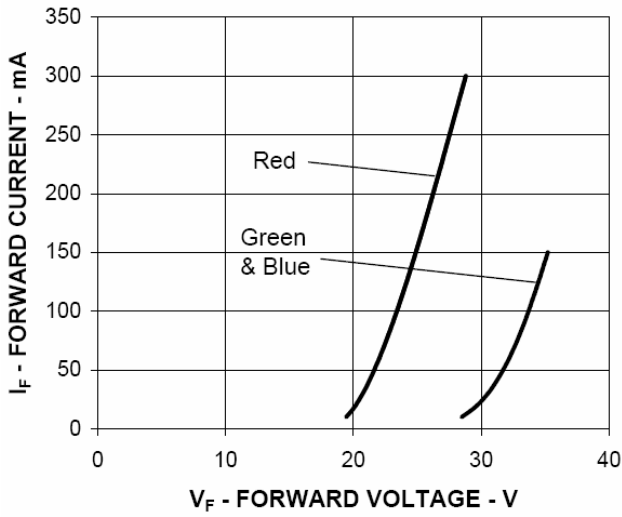

Figure 3. Forward current vs. forward voltage

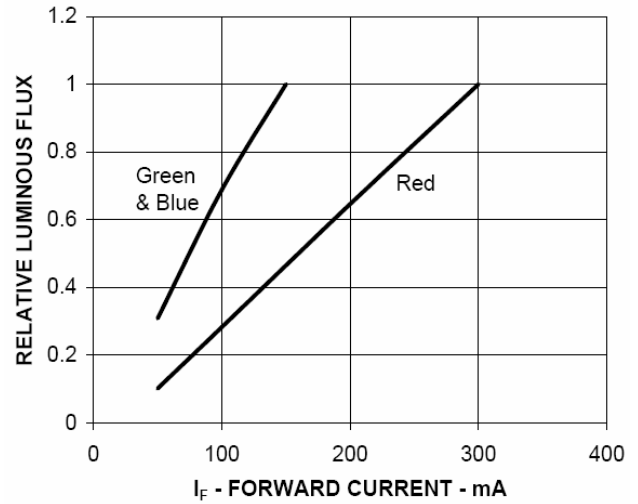

Figure 4. Relative luminous flux vs. forward current @ $T_j=25^{\circ}\text{C}$

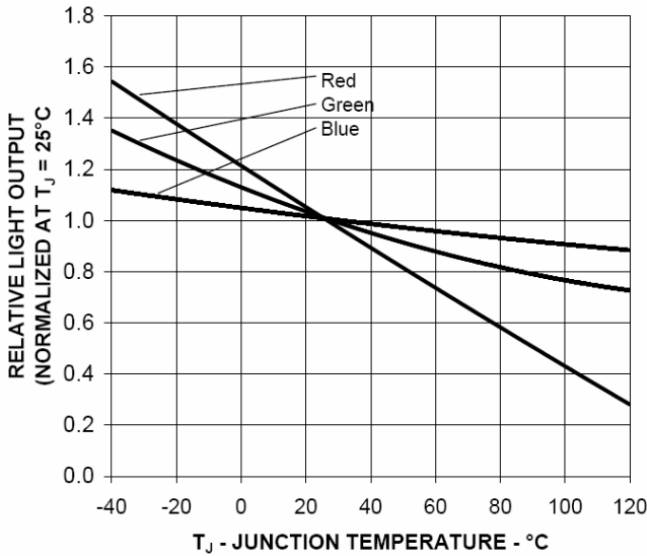

Figure 5. Relative light output vs junction temperature

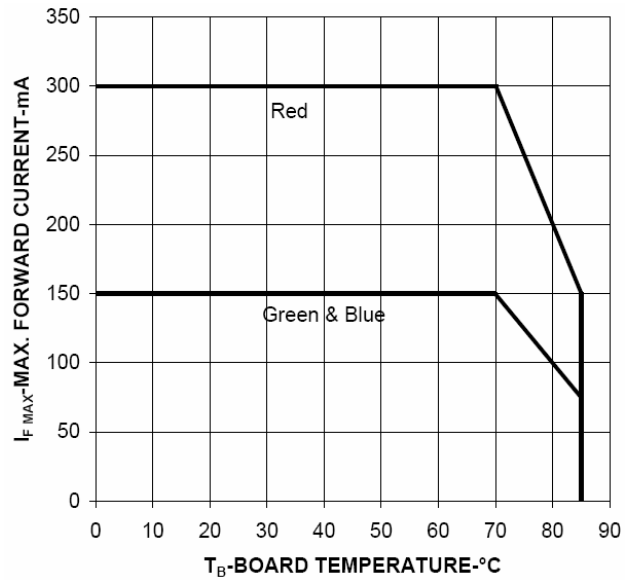

Figure 6. Maximum forward current vs board temperature T_B

Note:
Board temperature, T_B = temperature of the metal core PCB at the bottom of the LED.

Packing Information

ADJD-MJ50/51 and ADJD-MJ60/61 are supplied in plastic tray made of ESD safe material. Each tray contains 25 units.

Handling Cautions

1. The encapsulation material of the product is made of silicone for better reliability of the product. As silicone is a soft material, please do not press on the silicone or poke a sharp object onto the silicone. These might damage the product and cause premature failure. During assembly or handling, the unit should be held on the metal reflector or metal body.
2. When attaching the product to the heat sink, a thermally conductive compound is necessary as the interface between the metal core PCB of the product and the heat sink to ensure sufficient heat dissipation.

For product information and a complete list of distributors, please go to our web site: www.avagotech.com

Avago, Avago Technologies, and the A logo are trademarks of Avago Technologies, Limited in the United States and other countries. Data subject to change. Copyright © 2006 Avago Technologies Limited. All rights reserved. Obsoletes AV01-0448EN AV02-0280EN - May 16, 2007

