

RECTIFIERS

High Efficiency, ESP, 2.5 Amp to 20 Amp

1N5802-1N5806
1N5807-1N5811
1N5812-1N5816

FEATURES

- Exceptional Efficiency
- Low Forward Voltage
- Extremely Fast Reverse Recovery Time
- Extremely Fast Forward Recovery Time
- High Surge
- Small Size
- Rugged, High Current Termination
- Radiation Tolerant

DESCRIPTION

This series of High Efficiency Power Rectifiers allows circuit designers to design high current, high frequency supplies to 500 kHz with very low diode losses. The high forward surge capability makes these devices useful in protective circuits.

ABSOLUTE MAXIMUM RATINGS

Peak Inverse Voltage	2.5 Amp Series	6 Amp Series	20 Amp Series
50V	1N5802	1N5807	1N5812
75V	1N5803	1N5808	1N5813
100V	1N5804	1N5809	1N5814
125V	1N5805	1N5810	1N5815
150V	1N5806	1N5811	1N5816

	2.5 AMP SERIES	6 AMP SERIES	20 AMP SERIES
Maximum Average D.C. Output Current			
@ $T_L = 75^\circ\text{C}$, $L = 3\mu\text{s}$	2.5A	6.0A	—
@ $T_C = 100^\circ\text{C}$			20.0A
Non-Repetitive Sinusoidal			
Surge Current (8.3ms)	35A	125A	250A
Operating and Storage Temperature Range	-65°C to +175°C		
Thermal Resistance	2.5A and 6A Series	See Lead Temperature Derating Curve	
	20A Series	3.0°C/W	

MECHANICAL SPECIFICATIONS

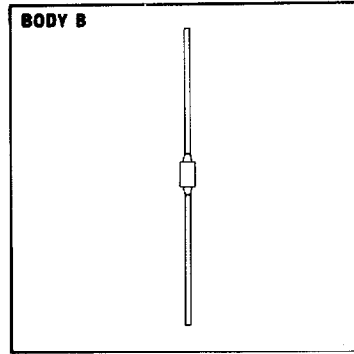
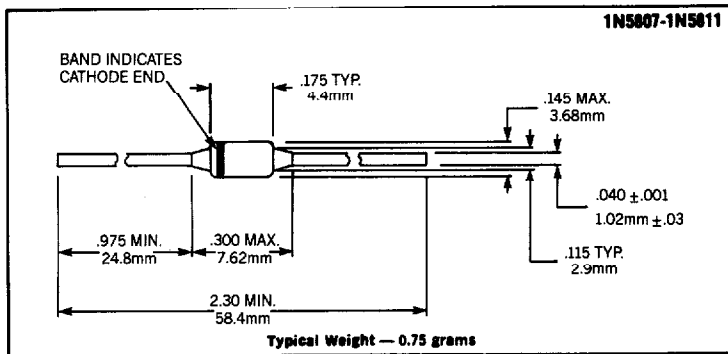
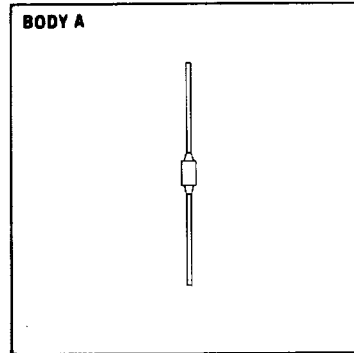
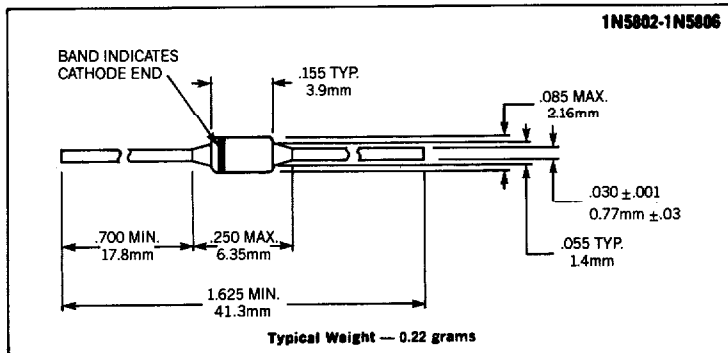

THESE DEVICES ALSO AVAILABLE IN SURFACE MOUNT PACKAGE. SEE SECTION 10

Microsemi Corp.
Watertown
The diode experts

MECHANICAL SPECIFICATIONS

1N5812-1N5816

Part Identification: Type number printed on metal case.
Polarity: Cathode to stud end
Max. Weight: 7.0 Grams
Installation Precautions: Maximum unlubricated stud torque: 10 inch pounds
Thermal Resistance: 3.0°C/W

Dimensions in inches.

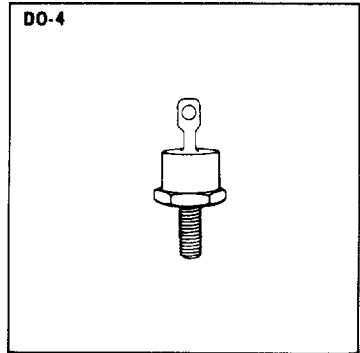

ELECTRICAL SPECIFICATIONS (at 25°C unless noted)

Type	PIV	Maximum Forward Voltage Drop*	Leakage Current @ PIV		Maximum Reverse Recovery Time t_{rr} t_{REC}	Typical Forward Recovery Time @ 1A Recover to 1V	Typical Forward Recovery Voltage @ 1A $t_r = 8ns$	Typical Junction Capacitance @ -10V
			25°C	100°C				
1N5802 1N5803 1N5804 1N5805 1N5806	50V 75V 100V 125V 150V	.875 @ 1A	1μA	50μA	25ns, 0.5A-0.5A-0.05A	15ns	1.5V	15pf
1N5807 1N5808 1N5809 1N5810 1N5811	50V 75V 100V 125V 150V	.875 @ 4A	5μA	150μA	30ns, 1.0-1.0-0.1A	15ns	1.5V	45pf
1N5812 1N5813 1N5814 1N5815 1N5816	50V 75V 100V 125V 150V	.900 @ 10A	10μA	750μA	35ns, 1.0-1.0-0.1A	15ns	1.5V	200pf

*Pulse width = 250ms

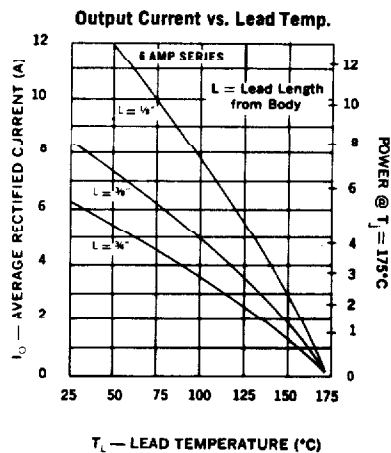
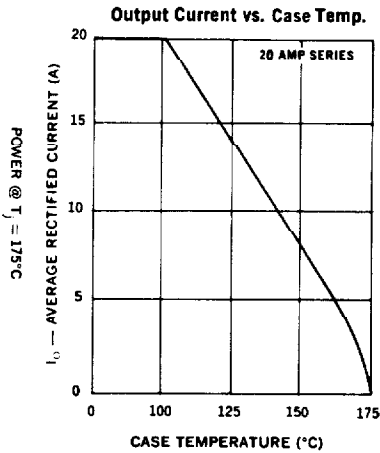
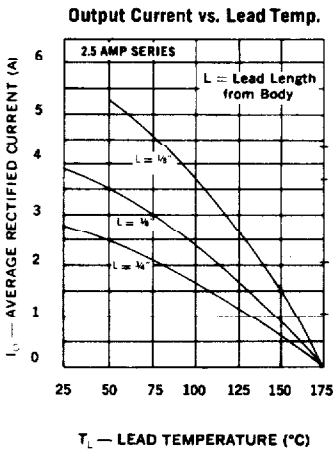

Typical Forward Current vs. Forward Voltage

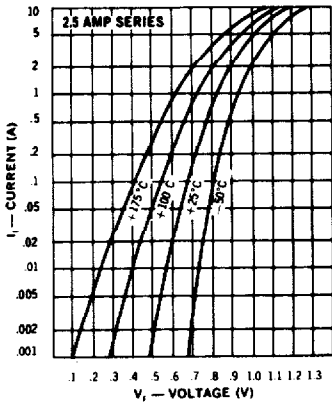

Typical Forward Current vs. Forward Voltage

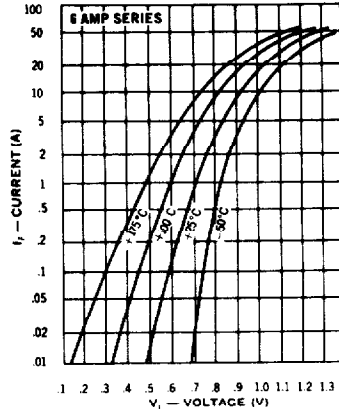

Typical Forward Current vs. Forward Voltage

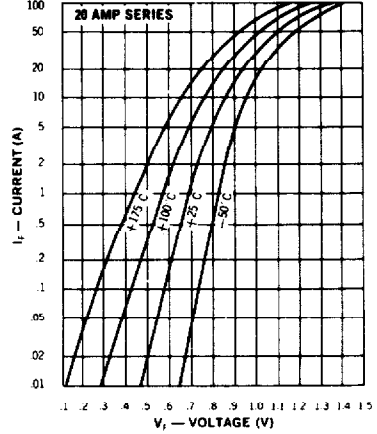

Typical Reverse Current vs. Voltage

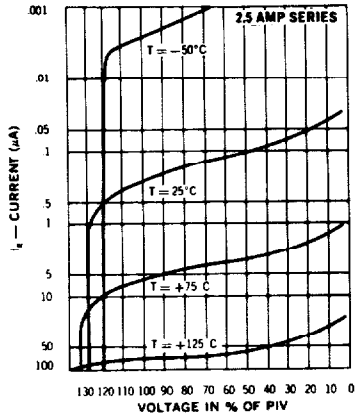

Typical Reverse Current vs. Voltage

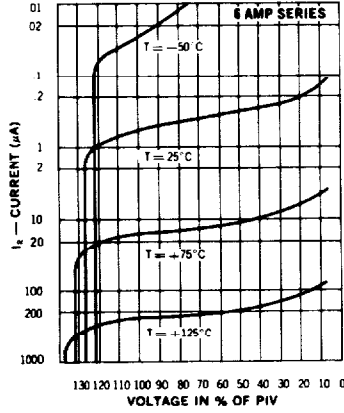

Typical Reverse Current vs. Voltage

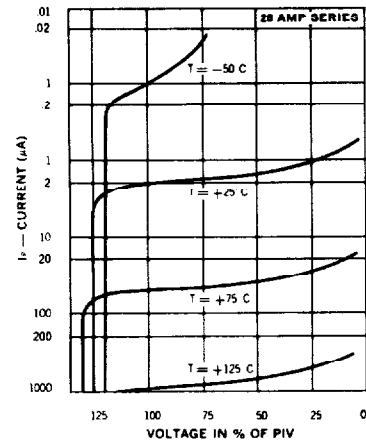

Reverse-Recovery Time Circuit

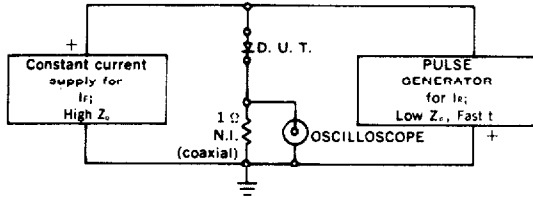

- NOTES:**
 1. Oscilloscope: Rise time ≤ 3 ns; input impedance = 50Ω .
 2. Pulse Generator: Rise time ≤ 8 ns; source impedance 10Ω .

Characteristic Waveform

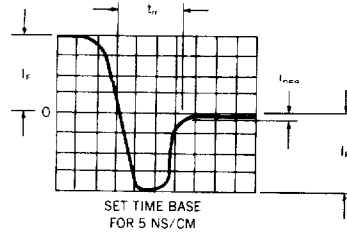

Forward Pulse Current vs. Duration

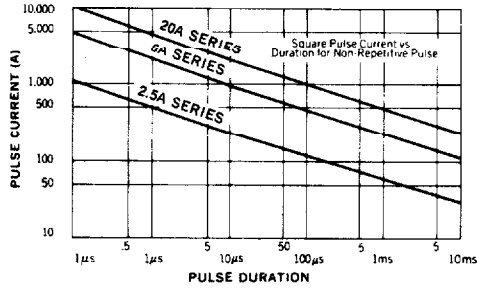

Multiple Surge Current vs. Duration

