



50ppm/°C Precision Micropower Shunt Voltage References with Multiple Reverse Breakdown Voltages

General Description

The LM4050/LM4051 are precision two-terminal, shunt-mode, bandgap voltage references available in fixed reverse breakdown voltages of 1.225V, 2.048V, 2.500V, 3.000V, 3.3V, 4.096V, and 5.000V. Ideal for space-critical applications, the LM4050/LM4051 are offered in the subminiature 3-pin SC70 surface-mount packages (1.8mm x 1.8mm), 50% smaller than comparable devices in SOT23 surface-mount package (SOT23 versions are also available).

Laser-trimmed resistors ensure excellent initial accuracy. With a 50ppm/°C temperature coefficient, these devices are offered in three grades of initial accuracy ranging from 0.1% to 0.5%. The LM4050/LM4051 have a 60µA to 15mA shunt-current capability with low dynamic impedance, ensuring stable reverse breakdown voltage accuracy over a wide range of operating temperatures and currents. The LM4050/LM4051 do not require an external stabilizing capacitor while ensuring stability with any capacitive loads.

The LM4050/LM4051 specifications are guaranteed over the temperature range of -40°C to +125°C.

Applications

Portable, Battery-Powered Equipment
 Notebook Computers
 Cell Phones
 Industrial Process Controls

Typical Operating Circuit

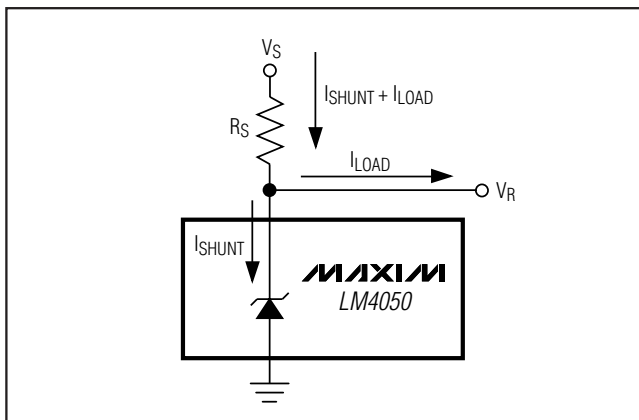

Features

- ◆ 50ppm/°C (max) Temperature Coefficient Guaranteed over the -40°C to +125°C Temperature Range
- ◆ Ultra-Small 3-Pin SC70 Package
- ◆ 0.1% (max) Initial Accuracy
- ◆ Wide Operating Current Range: 60µA to 15mA
- ◆ Low 28µVRMS Output Noise (10Hz to 10kHz)
- ◆ 1.225V, 2.048V, 2.500V, 3.000V, 3.3V, 4.096V, and 5.000V Fixed Reverse Breakdown Voltages
- ◆ No Output Capacitors Required
- ◆ Tolerates Capacitive Loads

Selector Guide

PIN	TEMP RANGE	PIN-PACKAGE	OUTPUT VOLTAGE (V)
LM4050_EM3-2.1+T	-40°C to +125°C	3 SOT23	2.048
LM4050_EX3-2.1+T	-40°C to +125°C	3 SC70	2.048
LM4050_EM3-2.5+T	-40°C to +125°C	3 SOT23	2.500
LM4050_EX3-2.5+T	-40°C to +125°C	3 SC70	2.500
LM4050_EM3-3.0+T	-40°C to +125°C	3 SOT23	3.000
LM4050_EX3-3.0+T	-40°C to +125°C	3 SC70	3.000
LM4050_EM3-3.3+T	-40°C to +125°C	3 SOT23	3.300
LM4050_EX3-3.3+T	-40°C to +125°C	3 SC70	3.300
LM4050_EX3-3.3V+T	-40°C to +125°C	3 SC70	3.300
LM4050_EM3-4.1+T	-40°C to +125°C	3 SOT23	4.096
LM4050_EM3-4.1V+T	-40°C to +125°C	3 SOT23	4.096
LM4050_EX3-4.1+T	-40°C to +125°C	3 SC70	4.096
LM4050_EM3-5.0+T	-40°C to +125°C	3 SOT23	5.000
LM4050_EM3-5.0V+T	-40°C to +125°C	3 SOT23	5.000
LM4050_EX3-5.0+T	-40°C to +125°C	3 SC70	5.000
LM4051_EM3-1.2+T	-40°C to +125°C	3 SOT23	1.225
LM4051_EX3-1.2+T	-40°C to +125°C	3 SC70	1.225

+Denotes a lead(Pb)-free/RoHS-compliant package.

T = Tape and reel.

V Denotes an automotive qualified part.

Ordering Information appears at end of data sheet.

Pin Configuration

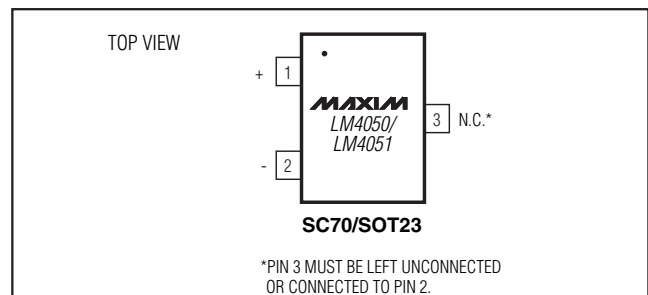

50ppm/°C Precision Micropower Shunt Voltage References with Multiple Reverse Breakdown Voltages

ABSOLUTE MAXIMUM RATINGS

Reverse Current (cathode to anode)20mA
 Forward Current (anode to cathode) 10mA
 Continuous Power Dissipation (T_A = +70°C)
 3-Pin SC70 (derate 2.17mW/°C above +70°C)174mW
 3-Pin SOT23 (derate 4.01mW/°C above +70°C)320mW

Operating Temperature Range
 LM4050/LM4051_E_ _ _-40°C to +125°C
 Storage Temperature Range-65°C to +150°C
 Junction Temperature+150°C
 Lead Temperature (soldering, 10s)+300°C
 Soldering Temperature (reflow)+260°C

Stresses beyond those listed under "Absolute Maximum Ratings" may cause permanent damage to the device. These are stress ratings only, and functional operation of the device at these or any other conditions beyond those indicated in the operational sections of the specifications is not implied. Exposure to absolute maximum rating conditions for extended periods may affect device reliability.

ELECTRICAL CHARACTERISTICS – 1.225V

(I_R = 100μA, T_A = T_{MIN} to T_{MAX}, unless otherwise noted. Typical values are at T_A = +25°C.) (Note 1)

PARAMETER	SYMBOL	CONDITIONS	MIN	TYP	MAX	UNITS	
Reverse Breakdown Voltage	V _R	T _A = +25°C	LM4051A (0.1%)	1.2238	1.2250	1.2262	V
			LM4051B (0.2%)	1.2226	1.2250	1.2275	
			LM4051C (0.5%)	1.2189	1.2250	1.2311	
Reverse Breakdown Voltage Tolerance (Note 2)	V _{RTOL}	LM4051A		±1.2	±7	mV	
		LM4051B		±2.4	±9		
		LM4051C		±6.0	±12		
Minimum Operating Current	I _{RMIN}		45	60		μA	
Average Reverse Voltage Temperature Coefficient (Notes 2, 3)	ΔV _R /ΔT	I _R = 10mA		±20		ppm/°C	
		I _R = 1mA		±15	±50		
		I _R = 100μA		±15			
Reverse Breakdown Voltage Change with Operating Current Change		I _{RMIN} ≤ I _R ≤ 1mA		0.7	1.5	mV	
		1mA ≤ I _R ≤ 12mA		2.5	8.0		
Reverse Dynamic Impedance (Note 3)	Z _R	I _R = 1mA, f = 120Hz, I _{AC} = 0.1I _R		0.5	1.5	Ω	
Wideband Noise	e _N	I _R = 100μA, 10Hz ≤ f ≤ 10kHz		20		μV _{RMS}	
Reverse Breakdown Voltage Long-Term Stability	ΔV _R	T = 1000h		120		ppm	

50ppm/°C Precision Micropower Shunt Voltage References with Multiple Reverse Breakdown Voltages

ELECTRICAL CHARACTERISTICS—2.048V

($I_R = 100\mu\text{A}$, $T_A = T_{\text{MIN}}$ to T_{MAX} , unless otherwise noted. Typical values are at $T_A = +25^\circ\text{C}$.) (Note 1)

PARAMETER	SYMBOL	CONDITIONS	MIN	TYP	MAX	UNITS	
Reverse Breakdown Voltage	V_R	$T_A = +25^\circ\text{C}$	LM4050A (0.1%)	2.0460	2.0480	2.0500	V
			LM4050B (0.2%)	2.0439	2.0480	2.0521	
			LM4050C (0.5%)	2.0378	2.0480	2.0582	
Reverse Breakdown Voltage Tolerance (Note 2)	V_{RTOL}	LM4050A		± 2.0	± 12	mV	
		LM4050B		± 4.0	± 14		
		LM4050C		± 10	± 20		
Minimum Operating Current	I_{RMIN}		45	65		μA	
Average Reverse Voltage Temperature Coefficient (Notes 2, 3)	$\Delta V_R/\Delta T$	$I_R = 10\text{mA}$		± 20		ppm/°C	
		$I_R = 1\text{mA}$		± 15	± 50		
		$I_R = 100\mu\text{A}$		± 15			
Reverse Breakdown Voltage Change with Operating Current Change		$I_{\text{RMIN}} \leq I_R \leq 1\text{mA}$		0.3	1.0	mV	
		$1\text{mA} \leq I_R \leq 15\text{mA}$		2.5	8.0		
Reverse Dynamic Impedance (Note 3)	Z_R	$I_R = 1\text{mA}$, $f = 120\text{Hz}$, $I_{\text{AC}} = 0.1I_R$	LM4050A/B	0.3	0.8	Ω	
			LM4050C	0.3	0.9		
Wideband Noise	e_N	$I_R = 100\mu\text{A}$, $10\text{Hz} \leq f \leq 10\text{kHz}$		28		μVRMS	
Reverse Breakdown Voltage Long-Term Stability	ΔV_R	$T = 1000\text{h}$		120		ppm	

LM4050/LM4051

50ppm/°C Precision Micropower Shunt Voltage References with Multiple Reverse Breakdown Voltages

LM4050/LM4051

ELECTRICAL CHARACTERISTICS—2.500V

($I_R = 100\mu\text{A}$, $T_A = T_{\text{MIN}}$ to T_{MAX} , unless otherwise noted. Typical values are at $T_A = +25^\circ\text{C}$.) (Note 1)

PARAMETER	SYMBOL	CONDITIONS		MIN	TYP	MAX	UNITS
Reverse Breakdown Voltage	V_R	$T_A = +25^\circ\text{C}$	LM4050A (0.1%)	2.4975	2.5000	2.5025	V
			LM4050B (0.2%)	2.4950	2.5000	2.5050	
			LM4050C (0.5%)	2.4875	2.5000	2.5125	
Reverse Breakdown Voltage Tolerance (Note 2)	V_{RTOL}	LM4050A		± 2.5	± 15		mV
		LM4050B		± 5.0	± 18		
		LM4050C		± 13	± 25		
Minimum Operating Current	I_{RMIN}			45	65		μA
Average Reverse Voltage Temperature Coefficient (Notes 2, 3)	$\Delta V_R/\Delta T$	$I_R = 10\text{mA}$		± 20			ppm/°C
		$I_R = 1\text{mA}$		± 15	± 50		
		$I_R = 100\mu\text{A}$		± 15			
Reverse Breakdown Voltage Change with Operating Current Change		$I_{\text{RMIN}} \leq I_R \leq 1\text{mA}$		0.3	1.0		mV
		$1\text{mA} \leq I_R \leq 15\text{mA}$		2.5	8.0		
Reverse Dynamic Impedance (Note 3)	Z_R	$I_R = 1\text{mA}$, $f = 120\text{Hz}$, $I_{\text{AC}} = 0.1I_R$	LM4050A/B		0.3	0.8	Ω
			LM4050C		0.3	0.9	
Wideband Noise	e_N	$I_R = 100\mu\text{A}$, $10\text{Hz} \leq f \leq 10\text{kHz}$		35			μV_{RMS}
Reverse Breakdown Voltage Long-Term Stability	ΔV_R	$T = 1000\text{h}$		120			ppm

50ppm/°C Precision Micropower Shunt Voltage References with Multiple Reverse Breakdown Voltages

LM4050/LM4051

ELECTRICAL CHARACTERISTICS—3.000V

($I_R = 100\mu\text{A}$, $T_A = T_{\text{MIN}}$ to T_{MAX} , unless otherwise noted. Typical values are at $T_A = +25^\circ\text{C}$.) (Note 1)

PARAMETER	SYMBOL	CONDITIONS		MIN	TYP	MAX	UNITS
Reverse Breakdown Voltage	V_R	$T_A = +25^\circ\text{C}$	LM4050A (0.1%)	2.9970	3.0000	3.0030	V
			LM4050B (0.2%)	2.9940	3.0000	3.0060	
			LM4050C (0.5%)	2.9850	3.0000	3.0150	
Reverse Breakdown Voltage Tolerance (Note 2)	V_{RTOL}	LM4050A		± 3.0	± 18	mV	
		LM4050B		± 6.0	± 21		
		LM4050C		± 15	± 30		
Minimum Operating Current	I_{RMIN}			45	67	μA	
Average Reverse Voltage Temperature Coefficient (Notes 2, 3)	$\Delta V_R/\Delta T$	$I_R = 10\text{mA}$		± 20		ppm/°C	
		$I_R = 1\text{mA}$		± 15	± 50		
		$I_R = 100\mu\text{A}$		± 15			
Reverse Breakdown Voltage Change with Operating Current Change		$I_{\text{RMIN}} \leq I_R \leq 1\text{mA}$		0.3	1.0	mV	
		$1\text{mA} \leq I_R \leq 15\text{mA}$		2.5	8.0		
Reverse Dynamic Impedance (Note 3)	Z_R	$I_R = 1\text{mA}$, $f = 120\text{Hz}$, $I_{\text{AC}} = 0.1I_R$	LM4050A/B		0.3	0.8	Ω
			LM4050C		0.3	0.9	
Wideband Noise	e_N	$I_R = 100\mu\text{A}$, $10\text{Hz} \leq f \leq 10\text{kHz}$		45		μVRMS	
Reverse Breakdown Voltage Long-Term Stability	ΔV_R	$T = 1000\text{h}$		120		ppm	

ELECTRICAL CHARACTERISTICS—3.300V

($I_R = 100\mu\text{A}$, $T_A = T_{\text{MIN}}$ to T_{MAX} , unless otherwise noted. Typical values are at $T_A = +25^\circ\text{C}$.) (Note 1)

PARAMETER	SYMBOL	CONDITIONS		MIN	TYP	MAX	UNITS
Reverse Breakdown Voltage	V_R	$T_A = +25^\circ\text{C}$	LM4050A (0.1%)	3.2967	3.3000	3.3033	V
			LM4050B (0.2%)	3.2934	3.3000	3.3066	
			LM4050C (0.5%)	3.2835	3.3000	3.3165	
Reverse Breakdown Voltage Tolerance (Note 2)	V_{RTOL}	LM4050A		± 3.0	± 18	mV	
		LM4050B		± 6.0	± 21		
		LM4050C		± 15	± 30		
Minimum Operating Current	I_{RMIN}			45	67	μA	
Average Reverse Voltage Temperature Coefficient (Notes 2, 3)	$\Delta V_R/\Delta T$	$I_R = 10\text{mA}$		± 20		ppm/°C	
		$I_R = 1\text{mA}$		± 15	± 50		
		$I_R = 100\mu\text{A}$		± 15			
Reverse Breakdown Voltage Change with Operating Current Change		$I_{\text{RMIN}} \leq I_R \leq 1\text{mA}$		0.3	1.0	mV	
		$1\text{mA} \leq I_R \leq 15\text{mA}$		2.5	8.0		
Reverse Dynamic Impedance (Note 3)	Z_R	$I_R = 1\text{mA}$, $f = 120\text{Hz}$, $I_{\text{AC}} = 0.1I_R$	LM4050A/B		0.3	0.8	Ω
			LM4050C		0.3	0.9	
Wideband Noise	e_N	$I_R = 100\mu\text{A}$, $10\text{Hz} \leq f \leq 10\text{kHz}$		50		μVRMS	
Reverse Breakdown Voltage Long-Term Stability	ΔV_R	$T = 1000\text{h}$		120		ppm	

50ppm/°C Precision Micropower Shunt Voltage References with Multiple Reverse Breakdown Voltages

ELECTRICAL CHARACTERISTICS—4.096V

($I_R = 100\mu\text{A}$, $T_A = T_{\text{MIN}}$ to T_{MAX} , unless otherwise noted. Typical values are at $T_A = +25^\circ\text{C}$.) (Note 1)

PARAMETER	SYMBOL	CONDITIONS	MIN	TYP	MAX	UNITS	
Reverse Breakdown Voltage	V_R	$T_A = +25^\circ\text{C}$	LM4050A (0.1%)	4.0919	4.0960	4.1001	V
			LM4050B (0.2%)	4.0878	4.0960	4.1042	
			LM4050C (0.5%)	4.0755	4.0960	4.1165	
Reverse Breakdown Voltage Tolerance (Note 2)	V_{RTOL}	LM4050A		± 4.1	± 25	mV	
		LM4050B		± 8.2	± 29		
		LM4050C		± 20	± 41		
Minimum Operating Current	I_{RMIN}			50	73	μA	
Average Reverse Voltage Temperature Coefficient (Notes 2, 3)	$\Delta V_R/\Delta T$	$I_R = 10\text{mA}$		± 30		ppm/°C	
		$I_R = 1\text{mA}$		± 20	± 50		
		$I_R = 100\mu\text{A}$		± 15			
Reverse Breakdown Voltage Change with Operating Current Change		$I_{\text{RMIN}} \leq I_R \leq 1\text{mA}$		0.5	1.2	mV	
		$1\text{mA} \leq I_R \leq 15\text{mA}$		3.0	10.0		
Reverse Dynamic Impedance (Note 3)	Z_R	$I_R = 1\text{mA}$, $f = 120\text{Hz}$, $I_{\text{AC}} = 0.1I_R$		0.5	1.0	Ω	
Wideband Noise	e_N	$I_R = 100\mu\text{A}$, $10\text{Hz} \leq f \leq 10\text{kHz}$		64		μVRMS	
Reverse Breakdown Voltage Long-Term Stability	ΔV_R	$T = 1000\text{h}$		120		ppm	

50ppm/°C Precision Micropower Shunt Voltage References with Multiple Reverse Breakdown Voltages

LM4050/LM4051

ELECTRICAL CHARACTERISTICS—5.000V

($I_R = 100\mu\text{A}$, $T_A = T_{\text{MIN}}$ to T_{MAX} , unless otherwise noted. Typical values are at $T_A = +25^\circ\text{C}$.) (Note 1)

PARAMETER	SYMBOL	CONDITIONS	MIN	TYP	MAX	UNITS	
Reverse Breakdown Voltage	V_R	$T_A = +25^\circ\text{C}$	LM4050A (0.1%)	4.9950	5.0000	5.0050	V
			LM4050B (0.2%)	4.9900	5.0000	5.0100	
			LM4050C (0.5%)	4.9750	5.0000	5.0250	
Reverse Breakdown Voltage Tolerance (Note 2)	V_{RTOL}	LM4050A		± 5.0	± 30	mV	
		LM4050B		± 10	± 35		
		LM4050C		± 25	± 50		
Minimum Operating Current	I_{RMIN}		54	80		μA	
Average Reverse Voltage Temperature Coefficient (Notes 2, 3)	$\Delta V_R / \Delta T$	$I_R = 10\text{mA}$		± 30		ppm/°C	
		$I_R = 1\text{mA}$		± 20	± 50		
		$I_R = 100\mu\text{A}$		± 15			
Reverse Breakdown Voltage Change with Operating Current Change		$I_{\text{RMIN}} \leq I_R \leq 1\text{mA}$		0.5	1.4	mV	
		$1\text{mA} \leq I_R \leq 15\text{mA}$		3.5	12.0		
Reverse Dynamic Impedance (Note 3)	Z_R	$I_R = 1\text{mA}$, $f = 120\text{Hz}$, $I_{\text{AC}} = 0.1I_R$		0.5	1.1	Ω	
Wideband Noise	e_N	$I_R = 100\mu\text{A}$, $10\text{Hz} \leq f \leq 10\text{kHz}$		80		μVRMS	
Reverse Breakdown Voltage Long-Term Stability	ΔV_R	$T = 1000\text{h}$		120		ppm	

Note 1: All devices are 100% production tested at $+25^\circ\text{C}$ and are guaranteed by design for $T_A = T_{\text{MIN}}$ to T_{MAX} , as specified.

Note 2: The limit over the full temperature range for the reverse breakdown voltage tolerance is defined as:

$$[V_{\text{RTOL}}] \pm [(\Delta V_R / \Delta T) \times (\text{max}\Delta T) \times (V_R)]$$

where $\Delta V_R / \Delta T$ is the V_R temperature coefficient, $\text{max}\Delta T$ is the difference from the $+25^\circ\text{C}$ reference point to T_{MIN} or T_{MAX} , and V_R is the reverse breakdown voltage.

The total tolerance over the full temperature range for the different grades where $\text{max}\Delta T = +100^\circ\text{C}$ is shown below:

- A grade: $\pm 0.6\% = \pm 0.1\% \pm 50\text{ppm}/^\circ\text{C} \times 100^\circ\text{C}$
- B grade: $\pm 0.7\% = \pm 0.2\% \pm 50\text{ppm}/^\circ\text{C} \times 100^\circ\text{C}$
- C grade: $\pm 1.0\% = \pm 0.5\% \pm 50\text{ppm}/^\circ\text{C} \times 100^\circ\text{C}$

Note 3: Guaranteed by design.

50ppm/°C Precision Micropower Shunt Voltage References with Multiple Reverse Breakdown Voltages

Typical Operating Characteristics

($I_R = 100\mu A$, SC70-3 package, $T_A = +25^\circ C$, unless otherwise noted.)

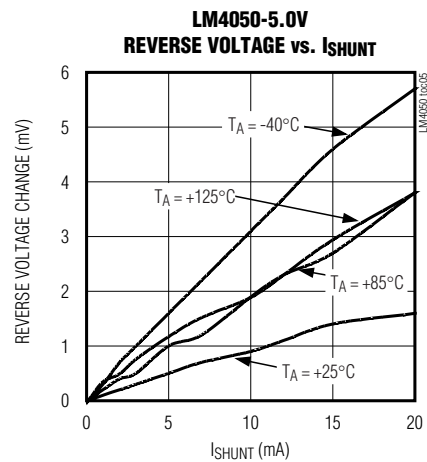
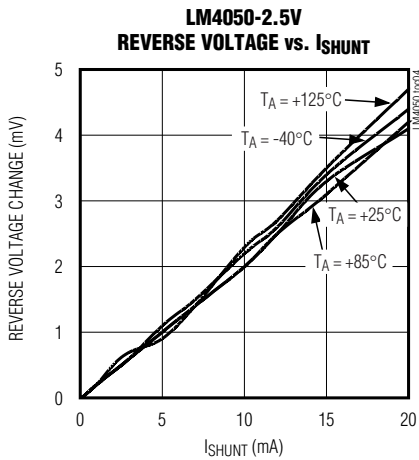
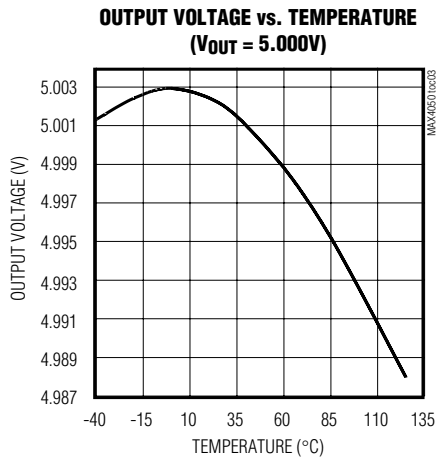
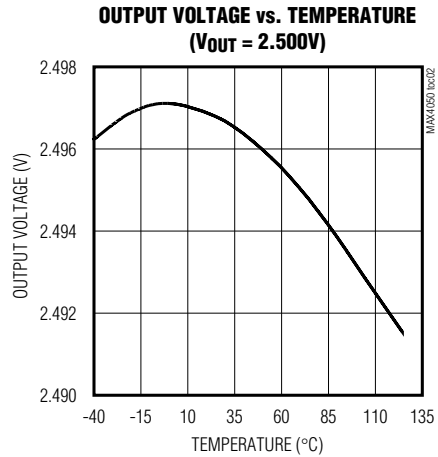
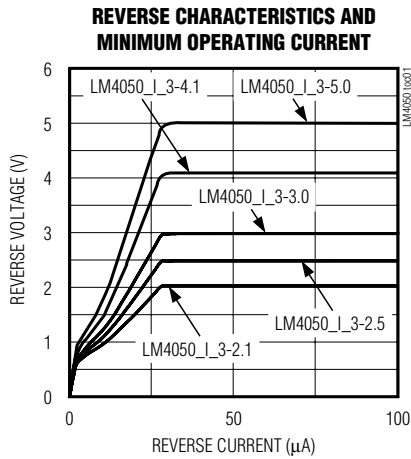

50ppm/°C Precision Micropower Shunt Voltage References with Multiple Reverse Breakdown Voltages

Typical Operating Characteristics (continued)

($I_R = 100\mu\text{A}$, SC70-3 package, $T_A = +25^\circ\text{C}$, unless otherwise noted.)

LM4050/LM4051

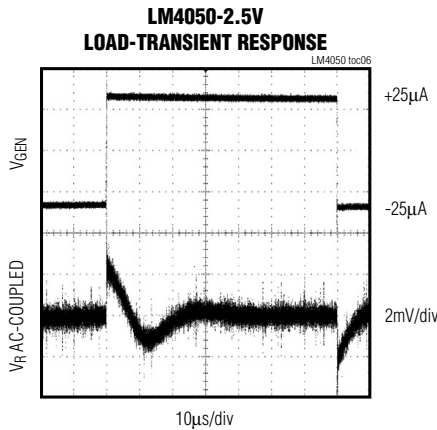

CH1: V_{GEN} 2V/div
CH2: V_R AC-COUPLED 2mV/div
 $I_{SHUNT} = 100\mu\text{A} \pm 25\mu\text{A}$, $R_L = 100\text{k}\Omega$, SEE FIGURE 1.

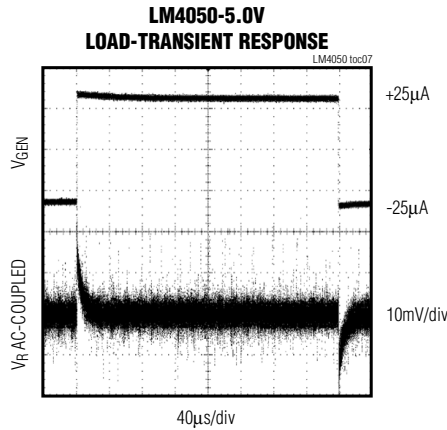

$I_{SHUNT} = 100\mu\text{A} \pm 25\mu\text{A}$
 $R_L = 100\text{k}\Omega$, SEE FIGURE 1.

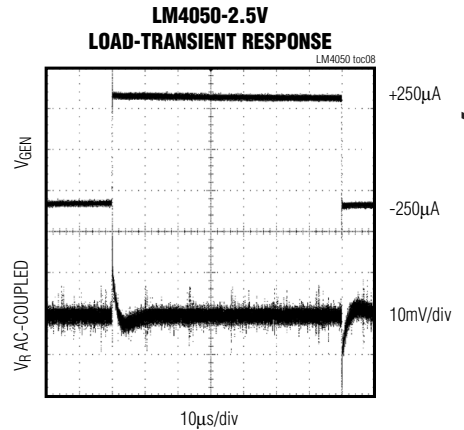

$I_{SHUNT} = 1\text{mA} \pm 250\mu\text{A}$
 $R_L = 10\text{k}\Omega$, SEE FIGURE 1.

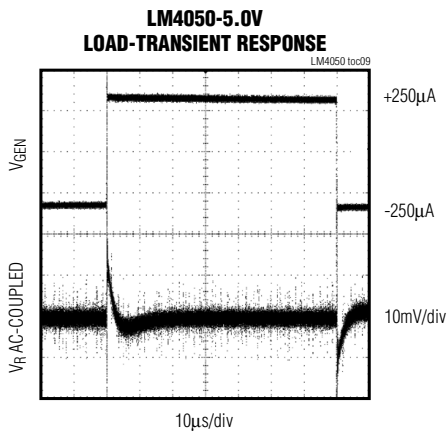

$I_{SHUNT} = 1\text{mA} \pm 250\mu\text{A}$
 $R_L = 10\text{k}\Omega$, SEE FIGURE 1.

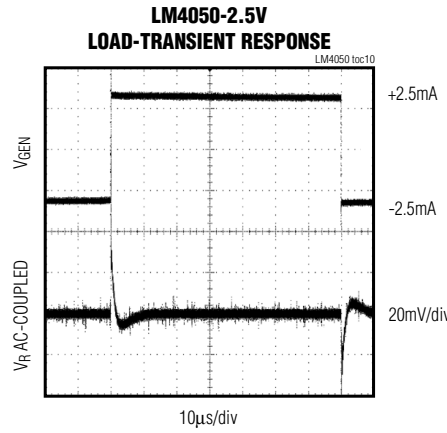

$I_{SHUNT} = 10\text{mA} \pm 2.5\text{mA}$
 $R_L = 1\text{k}\Omega$, SEE FIGURE 1.

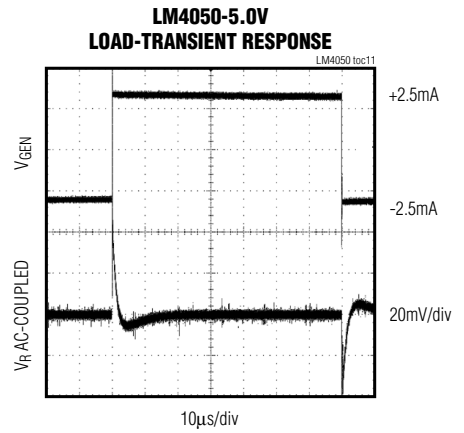

$I_{SHUNT} = 10\text{mA} \pm 2.5\text{mA}$
 $R_L = 1\text{k}\Omega$, SEE FIGURE 1.

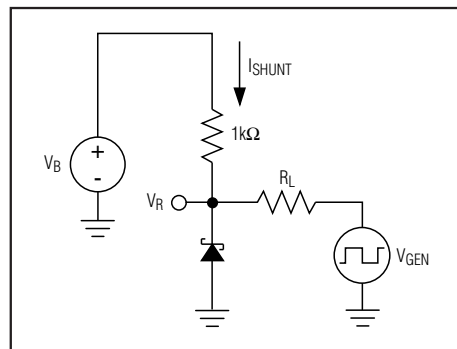
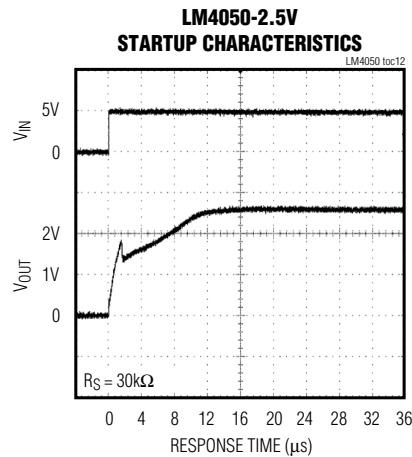

Figure 1. Load-Transient Test Circuit

50ppm/°C Precision Micropower Shunt Voltage References with Multiple Reverse Breakdown Voltages

Typical Operating Characteristics (continued)

($I_R = 100\mu A$, SC70-3 package, $T_A = +25^\circ C$, unless otherwise noted.)



SEE FIGURE 2.

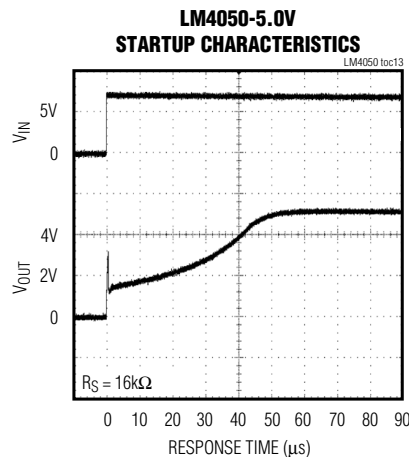

SEE FIGURE 2.

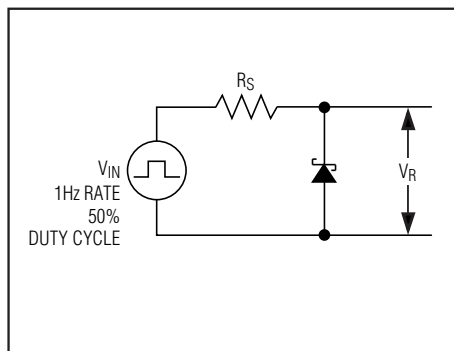
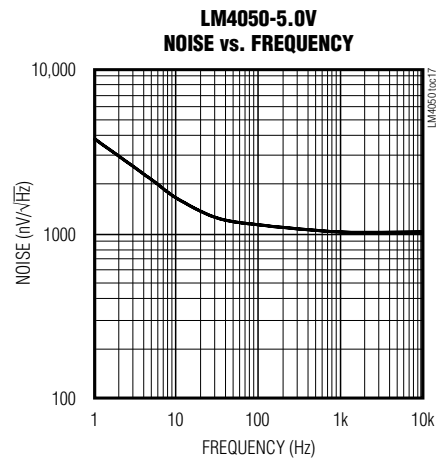
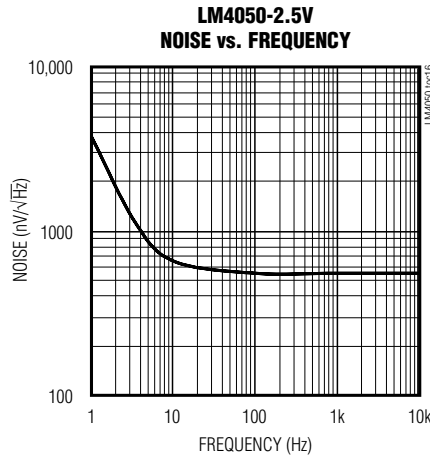
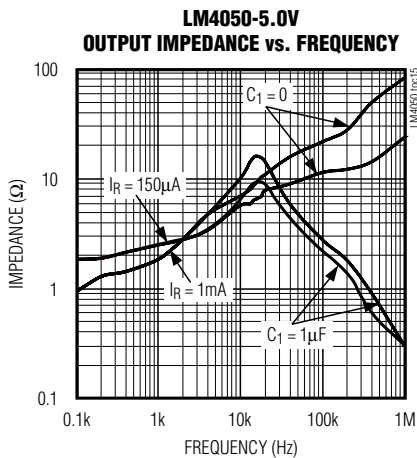
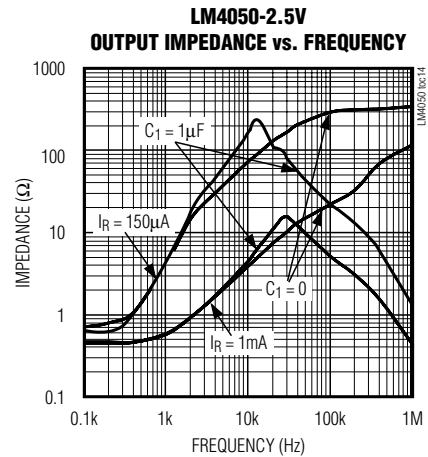

Figure 2. Startup Characteristics Test Circuit

50ppm/°C Precision Micropower Shunt Voltage References with Multiple Reverse Breakdown Voltages

LM4050/LM4051

Pin Description

PIN	NAME	FUNCTION
1	+	Positive Terminal of the Shunt Reference
2	-	Negative Terminal of the Shunt Reference
3	N.C.	No connection. Leave this pin unconnected or connected to pin 2.

Detailed Description

The LM4050/LM4051 shunt references use the bandgap principle to produce a stable, accurate voltage. The device behaves similarly to an ideal zener diode; a fixed voltage is maintained across its output terminals when biased with 60µA to 15mA of reverse current. The LM4050/LM4051 clamps to a voltage of one diode drop below ground when biased with forward currents up to 10mA.

Figure 3 shows a typical operating circuit. The LM4050/LM4051 are ideal for providing stable references from a high-voltage power supply.

Applications Information

The LM4050/LM4051s' internal pass transistors are used to maintain a constant output voltage (V_{SHUNT}) by sinking the necessary amount of current across a source resistor. The source resistance (R_S) is determined from the load current (I_{LOAD}) range, supply voltage (V_S) variations, V_{SHUNT} , and desired quiescent current.

Choose the value of R_S when V_S is at a minimum and I_{LOAD} is at a maximum. Maintain a minimum I_{SHUNT} of 60µA at all times. The R_S value should be large enough to keep I_{SHUNT} less than 15mA for proper regulation when V_S is maximum and I_{LOAD} is at a minimum. To prevent damage to the device, I_{SHUNT} should never exceed 20mA.

Therefore, the value of R_S is bounded by the following equation:

$$\frac{[V_S(\text{MIN}) - V_R]}{[60\mu\text{A} + I_{LOAD(\text{MAX})}]} > R_S > \frac{[V_S(\text{MAX}) - V_R]}{[20\text{mA} + I_{LOAD(\text{MIN})}]}$$

Choosing a larger resistance minimizes the total power dissipation in the circuit by reducing the shunt current ($P_{D(\text{TOTAL})} = V_S \times I_{SHUNT}$). Provide a safety margin to incorporate the worst-case tolerance of the resistor used. Ensure that the resistor's power rating is adequate, using the following general power equation:

$$P_{DR} = I_{SHUNT} \times (V_S(\text{MAX}) - V_{SHUNT})$$

Output Capacitance

The LM4050/LM4051 do not require external capacitors for frequency stability and are stable for any output capacitance.

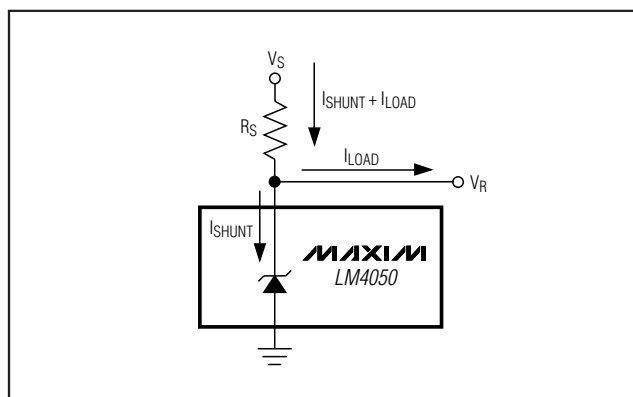

Figure 3. Typical Operating Circuit

Temperature Performance

The LM4050/LM4051 typically exhibit output voltage temperature coefficients within $\pm 15\text{ppm}/^\circ\text{C}$. The polarity of the temperature coefficients may be different from one device to another; some may have positive coefficients, and others may have negative coefficients.

High Temperature Operation

The maximum junction temperature of the LM4050/LM4051 is $+150^\circ\text{C}$. The maximum operating temperature for the LM4050/LM4051_E_ is $+125^\circ\text{C}$. At a maximum load current of 15mA and a maximum output voltage of 5V, the parts dissipate 75mW of power. The power dissipation limits of the 3-pin SC70 call for a derating value of $2.17\text{mW}/^\circ\text{C}$ above $+70^\circ\text{C}$ and thus for 75mW of power dissipation, the parts self-heat to 35.56°C above ambient temperature. If the ambient temperature is $+125^\circ\text{C}$, the parts operate at 159.56°C , thereby exceeding the maximum junction temperature value of $+150^\circ\text{C}$. For high-temperature operation, care must be taken to ensure the combination of ambient temperature, output power dissipation, and package thermal resistance does not conspire to raise the device temperature beyond that listed in the *Absolute Maximum Ratings*. Either reduce the output load current or the ambient temperature to keep the part within the limits.

50ppm/°C Precision Micropower Shunt Voltage References with Multiple Reverse Breakdown Voltages

Ordering Information

LM4050/LM4051

PART	OUTPUT VOLTAGE (V)	INITIAL ACCURACY (%)	TEMPCO (ppm/_C)	TEMP RANGE	PIN-PACKAGE	TOP MARK
LM4050AEM3-2.1+T	2.048	0.1	50	-40°C to +125°C	3 SOT23	FZTR
LM4050AEX3-2.1+T	2.048	0.1	50	-40°C to +125°C	3 SC70	ASM
LM4050BEM3-2.1+T	2.048	0.2	50	-40°C to +125°C	3 SOT23	FZTS
LM4050BEX3-2.1+T	2.048	0.2	50	-40°C to +125°C	3 SC70	ASN
LM4050CEM3-2.1+T	2.048	0.5	50	-40°C to +125°C	3 SOT23	FZTT
LM4050CEX3-2.1+T	2.048	0.5	50	-40°C to +125°C	3 SC70	ASO
LM4050AEM3-2.5+T	2.500	0.1	50	-40°C to +125°C	3 SOT23	FZTU
LM4050AEX3-2.5+T	2.500	0.1	50	-40°C to +125°C	3 SC70	ASP
LM4050BEM3-2.5+T	2.500	0.2	50	-40°C to +125°C	3 SOT23	FZTV
LM4050BEX3-2.5+T	2.500	0.2	50	-40°C to +125°C	3 SC70	ASQ
LM4050CEM3-2.5+T	2.500	0.5	50	-40°C to +125°C	3 SOT23	FZTW
LM4050CEX3-2.5+T	2.500	0.5	50	-40°C to +125°C	3 SC70	ASR
LM4050AEM3-3.0+T	3.000	0.1	50	-40°C to +125°C	3 SOT23	FZTX
LM4050AEX3-3.0+T	3.000	0.1	50	-40°C to +125°C	3 SC70	ASS
LM4050BEM3-3.0+T	3.000	0.2	50	-40°C to +125°C	3 SOT23	FZTY
LM4050BEX3-3.0+T	3.000	0.2	50	-40°C to +125°C	3 SC70	AST
LM4050CEM3-3.0+T	3.000	0.5	50	-40°C to +125°C	3 SOT23	FZTZ
LM4050CEX3-3.0+T	3.000	0.5	50	-40°C to +125°C	3 SC70	ASU
LM4050AEX3-3.3+T	3.300	0.1	50	-40°C to +125°C	3 SC70	AOJ
LM4050AEX3-3.3/V+T	3.300	0.1	50	-40°C to +125°C	3 SC70	+AUE
LM4050BEX3-3.3+T	3.300	0.2	50	-40°C to +125°C	3 SC70	AOK
LM4050CEX3-3.3+T	3.300	0.5	50	-40°C to +125°C	3 SC70	AOL
LM4050AEM3-4.1+T	4.096	0.1	50	-40°C to +125°C	3 SOT23	FZUA
LM4050AEX3-4.1+T	4.096	0.1	50	-40°C to +125°C	3 SC70	ASV
LM4050BEM3-4.1+T	4.096	0.2	50	-40°C to +125°C	3 SOT23	FZUB
LM4050BEM3-4.1/V+T	4.096	0.2	50	-40°C to +125°C	3 SOT23	+FZVL
LM4050BEX3-4.1+T	4.096	0.2	50	-40°C to +125°C	3 SC70	ASW
LM4050CEM3-4.1+T	4.096	0.5	50	-40°C to +125°C	3 SOT23	FZUC
LM4050CEX3-4.1+T	4.096	0.5	50	-40°C to +125°C	3 SC70	ASX
LM4050AEM3-5.0+T	5.000	0.1	50	-40°C to +125°C	3 SOT23	FZUD
LM4050AEX3-5.0+T	5.000	0.1	50	-40°C to +125°C	3 SC70	ASY
LM4050BEM3-5.0+T	5.000	0.2	50	-40°C to +125°C	3 SOT23	FZUE
LM4050BEX3-5.0+T	5.000	0.2	50	-40°C to +125°C	3 SC70	ASZ
LM4050CEM3-5.0+T	5.000	0.5	50	-40°C to +125°C	3 SOT23	FZUF
LM4050CEM3-5.0/V+T	5.000	0.5	50	-40°C to +125°C	3 SOT23	+FZVM
LM4050CEX3-5.0+T	5.000	0.5	50	-40°C to +125°C	3 SC70	ATA
LM4051AEM3-1.2+T	1.225	0.1	50	-40°C to +125°C	3 SOT23	FZTO
LM4051AEX3-1.2+T	1.225	0.1	50	-40°C to +125°C	3 SC70	ASJ
LM4051BEM3-1.2+T	1.225	0.2	50	-40°C to +125°C	3 SOT23	FZTP
LM4051BEX3-1.2+T	1.225	0.2	50	-40°C to +125°C	3 SC70	ASK
LM4051CEM3-1.2+T	1.225	0.5	50	-40°C to +125°C	3 SOT23	FZTQ
LM4051CEX3-1.2+T	1.225	0.5	50	-40°C to +125°C	3 SC70	ASL

50ppm/°C Precision Micropower Shunt Voltage References with Multiple Reverse Breakdown Voltages

Chip Information

PROCESS: BiCMOS

Package Information

For the latest package outline information and land patterns (footprints), go to www.maxim-ic.com/packages. Note that a "+", "#", or "-" in the package code indicates RoHS status only. Package drawings may show a different suffix character, but the drawing pertains to the package regardless of RoHS status.

PACKAGE TYPE	PACKAGE CODE	OUTLINE NO.	LAND PATTERN NO.
3 SOT23	U3+1	21-0051	90-0179
3 SC70	X3+2	21-0075	90-0208

LM4050/LM4051

50ppm/°C Precision Micropower Shunt Voltage References with Multiple Reverse Breakdown Voltages

Revision History

REVISION NUMBER	REVISION DATE	DESCRIPTION	PAGES CHANGED
0	7/02	Initial release	—
4	5/09	Added lead-free notation and corrected topmarks in the <i>Ordering Information and Selector Guide</i> sections	1, 12
5	5/11	Added automotive packages and updated the <i>Absolute Maximum Ratings</i> .	1, 2

Maxim cannot assume responsibility for use of any circuitry other than circuitry entirely embodied in a Maxim product. No circuit patent licenses are implied. Maxim reserves the right to change the circuitry and specifications without notice at any time.

14 **Maxim Integrated Products, 120 San Gabriel Drive, Sunnyvale, CA 94086 408-737-7600**