

## EF9365 • EF9366

### GRAPHIC DISPLAY PROCESSOR (GDP)

The GDP is a true high resolution graphic display processor, which contains all the functions required to process vector generation at a very high speed and to generate all the timing signals required for interfacing interlaced or non interlaced video data on a raster scan CRT display compatible with the CCIR 625 line 50 Hz standard.

The GDP flexibility results from its direct interfacing with any 8-bit MPU bus and its 11 internal registers.

The GDP's main features are :

- Selectable resolutions in black and white or color :  
**EF9365** : 512 x 512 (interlaced scan)  
           256 x 256, 128 x 128, 64 x 64 (non interlaced scan)  
**EF9366** : 512 x 256 (non interlaced scan)
- High speed vector plot well suited to animation (up to 1 500 000 dots/s. and an average value of 900 000 dots/s.) - 4 types of lines.
- Multiplexed address and refresh for 16K or 64K dynamic RAMs
- No limitation on the number of selectable memory planes (colors, grey levels or any other attributes)
- Multipage application capability
- On-chip full ASCII character generator (96) - maximum alphanumeric screen density : 85 x 57 - programmable sizes and orientations
- Direct interfacing with the monitor through the composite synchro and blanking signals
- Automatic allocation of display memory in refresh, write, dump, and display cycles
- Light pen registers and control signals
- Three types of interrupt requests
- Fully static design
- TTL compatible I/O
- Single + 5 volt supply.

### MOS

(N - CHANNEL, SILICON - GATE)

### GRAPHIC DISPLAY PROCESSOR (GDP)

#### CASE CB-182

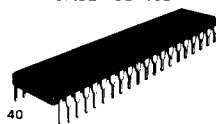

P SUFFIX  
PLASTIC PACKAGE

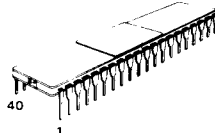

C SUFFIX  
CERAMIC PACKAGE

### TYPICAL APPLICATION

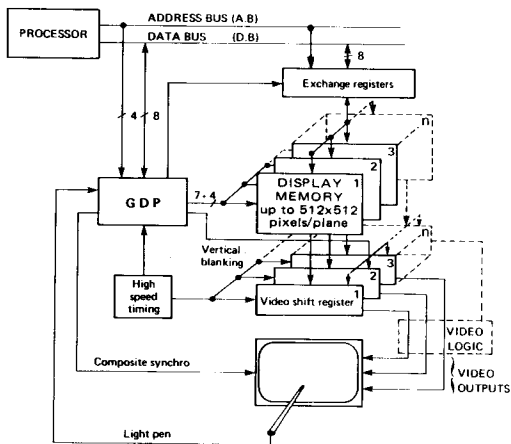

Developed in conjunction with the Ecole Normale Supérieure.

### PIN ASSIGNMENT

CK	1	40	VCC
DAD5	2	39	DAD1
DAD4	3	38	DAD2
DAD3	4	37	DAD0
DAD6	5	36	MSL1
MSL0	6	35	MSL3
MSL2	7	34	SYNC
FMAT	8	33	D0
A0	9	EF9365 32	D1
A1	10	EF9366 31	D2
A2	11	30	D3
A3	12	29	D4
IRQ	13	28	D5
DW	14	27	D6
DIN	15	26	D7
VB	16	25	BLK
E	17	24	WHITE
R/W	18	23	WO
MFREE	19	22	ALL
VSS	20	21	LPCK

BLOCK DIAGRAM

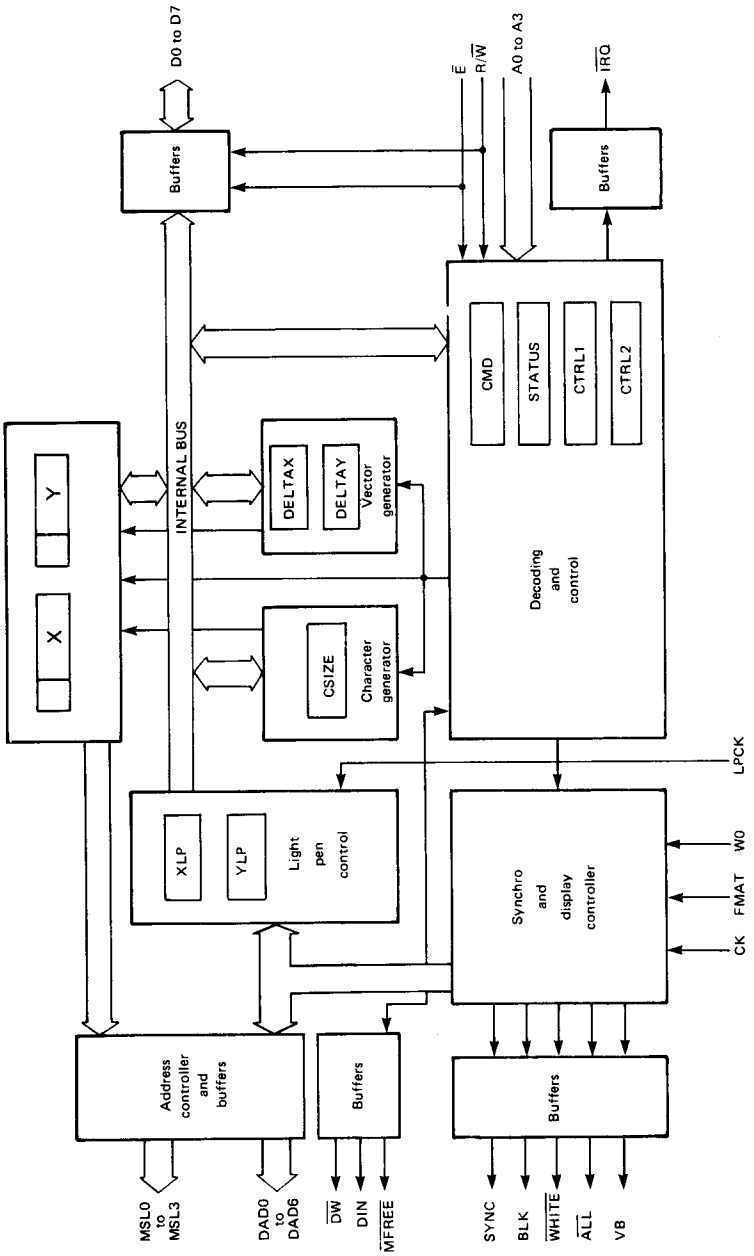

**GENERAL DESCRIPTION**

Developed using NMOS technology, the GDP is an intelligent raster scan video display controller, fully programmable via an eight-bit microprocessor bus. Besides all the timing logic functions required to generate the video, sync and blanking signals, the GDP includes two hardwired display processors : a vector and a character generator.

This unique feature allows an ultrafast screen writing speed (the 512 dot diagonal may be written in less than 700  $\mu$ s) at almost no microprocessor processing cost.

The GDP is particularly well-suited to all applications in which the display memory is not directly addressed by the MPU. This feature allows a total asynchronism between the MPU and the GDP memory cycles and preserves the whole MPU memory addressing space.

Nevertheless, where direct exchange between the micro-processor and the memory is necessary, the on-chip allocation controller will allow this exchange without display interference.

The GDP is programmable using 11 internal registers occupying 16 consecutive addresses. These registers can also be modified by the GDP's hardwired processors while a command is being executed.

**Note :** A summary of data codes and registers is given in the Register address table. Hexadecimal values are subscripted 16 and the register bits are numbered as follows :

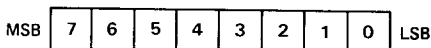

**MAXIMUM RATINGS**

Parameter	Symbol	Value	Unit
Supply voltage	$V_{CC}$	-0.3 to + 7.0	V
Input voltage	$V_{in}$	-0.3 to + 7.0	V
Operating temperature	$T_A$	0 to + 70	$^{\circ}$ C
Storage temperature	$T_{stg}$	- 55 to + 150	$^{\circ}$ C

The GDP inputs are protected against high static voltages and electric fields ; nevertheless, normal precautions should be taken to avoid voltages above the limit values on this high impedance circuit.

**STATIC ELECTRICAL PARAMETERS** ( $V_{CC} = 5V \pm 5\%$ ,  $V_{SS} = 0$ ,  $T_A = 0$  to  $70^{\circ}$  C unless otherwise noted)

Parameter	Symbol	Min	Typ	Max	Unit
Input high voltage except CK	$V_{IH}$	$V_{SS} + 2.2$	-	$V_{CC}$	V
Input high voltage CK	$V_{IHCK}$	$V_{SS} + 3.5$	-	$V_{CC}$	V
Input low voltage	$V_{IL}$	$V_{SS} - 0.3$	-	$V_{SS} + 0.8$	V
Input leakage current ( $V_{in} = 0$ to $5.25$ V, $V_{CC} = \text{max}$ )	$I_{in}$	-	1.0	2.5	$\mu$ A
Output high voltage ( $I_{load} = -100 \mu$ A, $V_{CC} = \text{min}$ )	$V_{QH}$	$V_{SS} + 2.4$	-	-	V
Output low voltage ( $I_{load} = 1.6$ mA, $V_{CC} = \text{min}$ )	$V_{OL}$	-	-	$V_{SS} + 0.4$	V
Supply current	$I_{CC}$	-	80	-	mA
Capacitance ( $V_{in} = 0$ , $T_A = 25^{\circ}$ C, $f = 1.0$ MHz)	$C_{in}$	-	-	12	pF
	$C_{out}$	-	-	12	pF

**TEST LOADS**

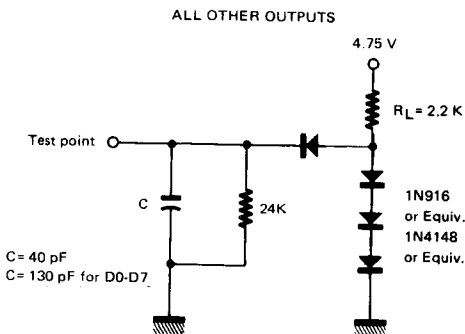
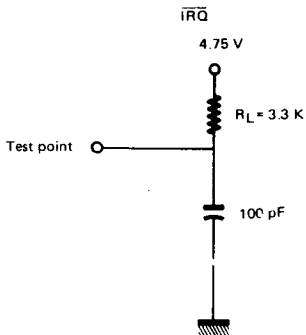

**DYNAMIC OPERATING CONDITIONS**

(V<sub>DD</sub> = 5,0 V ± 5 %, V<sub>SS</sub> = 0 V ; T<sub>A</sub> = 0 to + 70 ° C unless otherwise noted)

Time (ns)	Symbol	Min	Max
Clock period	t <sub>CK</sub>	560	
CK pulse width, low	t <sub>CKL</sub>	330	
CK pulse width, high	t <sub>CKH</sub>	190	
CK low to valid DAD	CKLDAD		320
CK high to valid DAD	CKHDAD		180
CK low to valid SYNC	CKLSYNC		300
CK low to valid BLK	CKLBLK		310
CK low to valid VB	CKLVB		500
CK low to valid ALL	CKLALL		300
CK low to valid MSL	CKLMSL		300
CK low to valid DW	CKLDW		310
CK low to valid MFREE	CKLMFR		500
CK low to valid DIN	CKLDIN		310
CK low to valid IRQ	CKLIRQ		1500
CK low to valid WHITE	CKLWHI		530
E pulse width, low	t <sub>EL</sub>	450	
E pulse width, high	t <sub>EH</sub>	430	
Address pre-setup time	t <sub>AS</sub>	160	
Address hold time	t <sub>AH</sub>	10	
Data pre-setup time (write)	t <sub>DSW</sub>	260	
Data setup time (read)	t <sub>DDR</sub>		320
Data hold time (read)	t <sub>DHR</sub>	10	
IRQ release time	t <sub>IR</sub>		1600
LPCK high to WHITE high (if command 08 <sub>16</sub> )	LPHW		1600
LPCK high to IRQ low	LPHIRQ		1600
LPCK high hold time	t <sub>LPCKH</sub>	150	
CK and E rise times	t <sub>r</sub>		20
CK and E fall times	t <sub>f</sub>		20

**CLOCK AND OUTPUT CHARACTERISTICS**

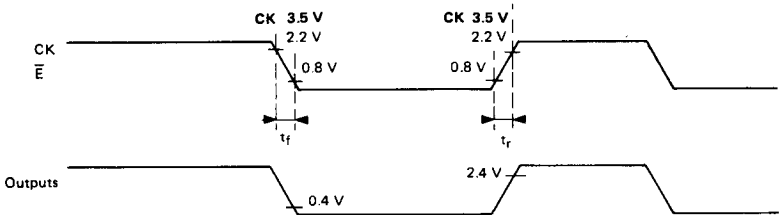

**IRQ RELEASE TIME**

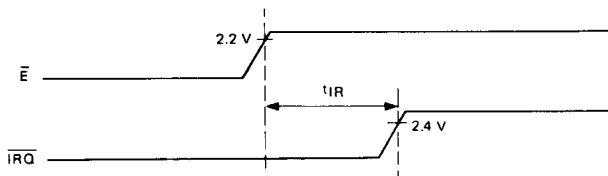

MICROPROCESSOR BUS, WRITE ACCESS

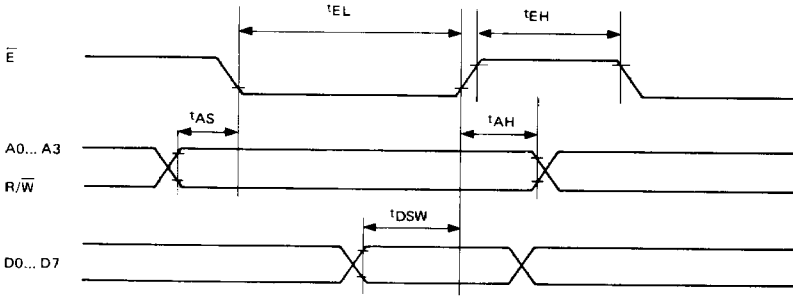

MICROPROCESSOR BUS, READ ACCESS

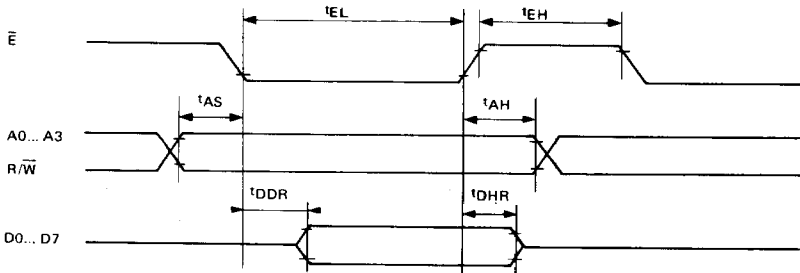

SYNCHRONOUS SIGNALS WITH CK INPUT

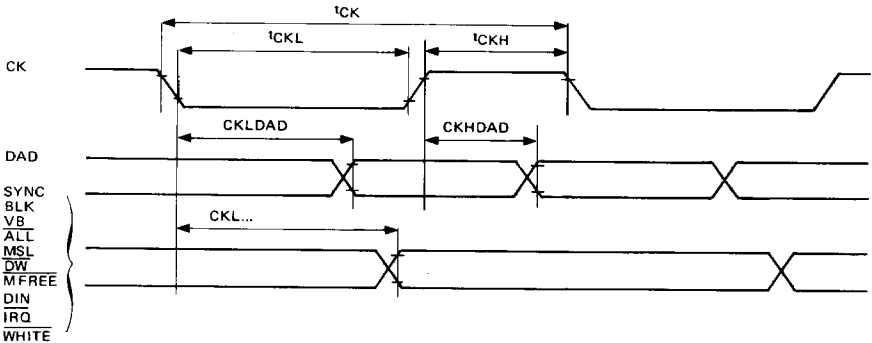

LIGHT PEN SIGNALS

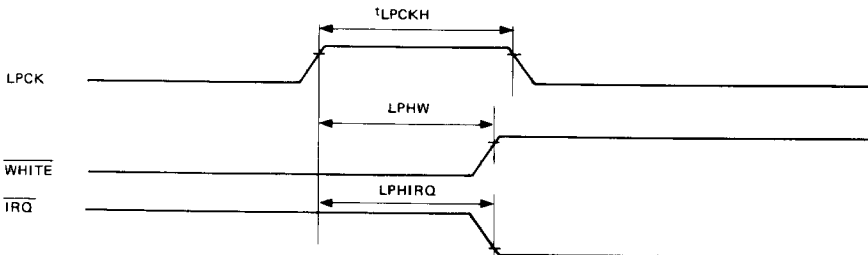

PIN DESCRIPTION

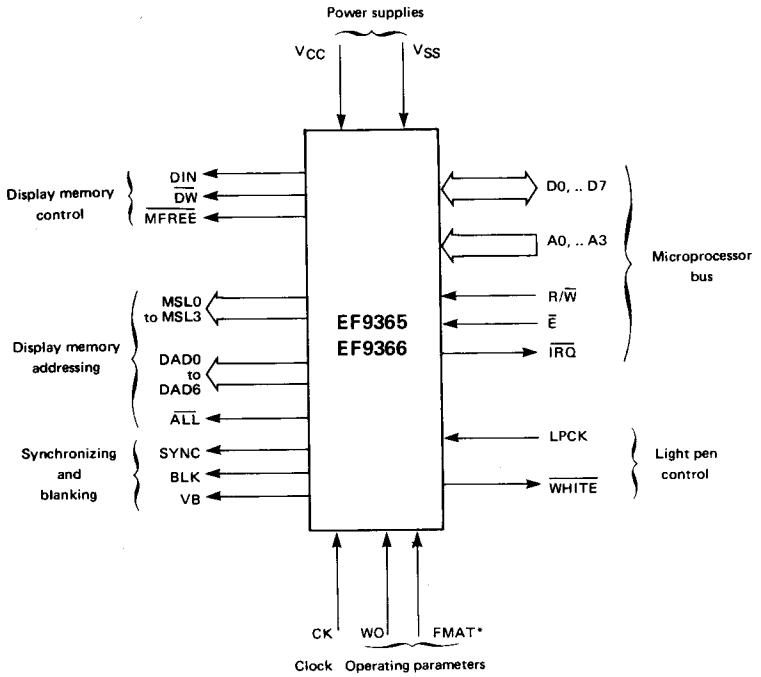

\*FMAT should be connected to VCC in the EF9366.

## POWER SUPPLY, CLOCK AND OPERATING PARAMETERS

NAME	PIN TYPE	N°	FUNCTION	DESCRIPTION
VSS	S	20	Power supply	Ground
VCC	S	40	Power supply	+ 5 V
CK	I	1	Clock	Master clock. All internal processor states are modified on the falling edge of this signal. The whole circuit logic is static and the cycle of this clock needs only to be adjusted according to the shape and accuracy the synchronizing signals should feature. DAD memory address multiplexing signal. If CK is low, low addresses (or row addresses for the memory) are those that are output on DAD. For SYNC to be in compliance with the applicable CCIR standards (FMAT high) the input frequency on CK should be 1.750 MHz. If FMAT is low or for the EF9366, the frame frequency equals 50 Hz provided that the input frequency on CK is 1.7472 MHz.
FMAT	I	8	Format	EF9365 should be connected to VCC for a 512 line vertical resolution (interlaced scan) and to VSS for 256 lines or less (non-interlaced scan). The shape of the synchronizing signals, the address distribution on DAD and the MSL output functions are changed by this input.  EF9366 : not used (should be connected to VCC).
WO	I	23	Write only	When WO is high, memory refresh nor display no longer exist. The hard wired write processors may operate without being interrupted. The ALL signal is always high.

## SYNCHRONIZING AND BLANKING SIGNALS

SYNC	O	34	Video monitor synchronizing	Video monitor line and frame sync signal. The SYNC signal complies with CCIR 625-line 50 Hz standard provided the CK frequency is 1.750 MHz and FMAT is high. If FMAT is low or for the EF9366, the frames are no longer interlaced and all comprise 312 lines. This output is not affected by the WO input and CTRL1 register.
BLK	O	25	Blanking	This signal is high apart from the display window (writing or refresh). It is always high if bit 2 in register CTRL1 is high, but it is not affected by the WO input.
VB	O	16	Vertical blanking	This signal is not affected by WO and register CTRL1. High during vertical blanking.

## DISPLAY MEMORY ADDRESSING SIGNALS

DAD0 to DAD6	O	37,39,38,43,2,5	Display address	Addresses that are multiplexed by the CK signal. Provided for the automatic refresh of the 16K or 64K dynamic memories.
MSL0 to MSL3	O	6,36,7,35	Memory select	Pixel write select signals (see section : <b>Display memory configuration.</b> )
ALL	O	22	Access to all memory units	This signal makes it possible to discriminate between the collective memory accesses to all chips (display, refresh or erase), and the memory accesses to a single pixel for vector or character writing purposes. This signal is low for collective access.

## DISPLAY MEMORY CONTROL SIGNALS

NAME	PIN TYPE	N°	FUNCTION	DESCRIPTION
DIN	O	15	Display in	Selection of the memory data code corresponding to the display screen in the 'off' condition (active when high). For a black-and-white display (1 bit per pixel), DIN may directly be the storage entry data.
$\overline{DW}$	O	14	Display write	Display memory write signal. Active when low.
$\overline{MFREE}$	O	19	Memory free	Signal low during the next memory idle period following the 0F <sub>16</sub> command. This signal allows exchanges between the microprocessor and the X and Y flagged memory segment without affecting the display.

## MICROPROCESSOR BUS SIGNALS

D0-D7	I/O	33 to 26	Data bus	I/O buffers opening is controlled through $\overline{E}$ , and the related direction through R/ $\overline{W}$ .
A0-A3	I	9 to 12	Address bus	Address of the register involved in microprocessor access.
R/ $\overline{W}$	I	18	Read/write signal	Read/write signal. Write when low.
$\overline{E}$	I	17	Enable	Bus exchange synchronizing and enabling signal.
$\overline{IRQ}$	O	13	Interrupt request	Interrupt request towards the microprocessor, programmable through register CTRL1. Open drain output.

## LIGHT PEN OPERATING SIGNALS

WHITE	O	24	Forcing to white level	Forces white level on video signal, for use of the light pen. Active when low.
LPCK	I	21	Light pen strobe	Light pen input. When the mechanism is set, a rising edge loads into registers XLP and YLP the current display address and sets the XLP register's LSB high.



## REGISTER DESCRIPTION

**X AND Y REGISTERS** (Addresses :  $8_{16}$ ,  $9_{16}$ ,  $A_{16}$ ,  $B_{16}$ )

The X and Y registers are 12-bit read-write registers. They indicate the position of the next dot to be written into the display memory. They have no connection at all with the video signal generating scan, but they point the write address, in the same way as the pen address on a plotter.

These 2 registers are incremented or decremented, prior to each write operation into the display memory, by the internal vector and character generators, or they may be directly positioned by the microprocessor.

This  $2 \times 12$  bit write address covers a  $4096 \times 4096$  point addressing space. Only the LSBs are used here, since the maximum definition of the picture actually stored is  $512 \times 512$  pixels (picture elements).

The MSBs are either ignored or used to inhibit writing where the actual screen is regarded as being a window within a  $4096 \times 4096$  space.

The above features along with the relative mode description of all picture component elements make it possible to automatically solve the great majority of edge cut-off problems.

**DELTAX AND DELTAY REGISTERS** (Addresses :  $5_{16}$ ,  $7_{16}$ ).

The DELTAX and DELTAY registers are 8-bit read-write registers. They indicate to the vector generator the projections of the next vector to be plotted, on the X and Y axes respectively. Such values are unsigned integers. The plotting of a vector is initiated by a write operation in the command register (CMD).

**CSIZE REGISTER** (Address :  $3_{16}$ )

The CSIZE register is an 8-bit read-write register. It indicates the scaling factors of X and Y registers for the symbols and characters. 98 characters are generated from a  $5 \times 8$  pixel matrix defined by an internal ROM. In the standard version, it contains the alphanumeric characters in the ASCII code which may be printed, together with a number of special symbols.

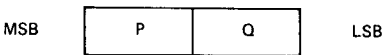

Each symbol can be increased by a factor P(X) or Q(Y). These factors are independent integers which may each vary from 1 to 16 and which are defined by the CSIZE register. The symbol generation sequence is started after writing the ASCII code of the symbol to be represented in the CMD register.

**CTRL1 REGISTER** (Address :  $1_{16}$ ).

The CTRL1 register is a 7-bit read-write register, through which the general circuit operation may be fed with the required parameters.

- Bit 0 : When low, this bit inhibits writing in display memory (equivalent to pen or eraser up).  
When high, this bit enables writing in display memory (pen or eraser down).  
This bit controls the  $\overline{DW}$  output.
- Bit 1 : When low, this bit selects the eraser.  
When high, this bit selects the pen.  
This bit controls the DIN output.
- Bit 2 : When low, this bit selects normal writing mode (writing apart from the display and refresh periods, which are a requirement for the dynamic storages) in display memory.  
When high, this bit selects the high speed writing mode : the display periods are deleted. Only the dynamic storage refresh periods are retained.
- Bit 3 : When low, this bit indicates that the  $4096 \times 4096$  space is being used (the 12 X and Y bits are significant)  
When high, this bit selects the cyclic screen operating mode.
- Bit 4 : When low, this bit inhibits the interrupt triggered by the light pen sequence completion.  
When high, this bit enables the interrupt.
- Bit 5 : When low, this bit inhibits the interrupt release by vertical blanking.  
When high, this bit enables the interrupt.
- Bit 6 : When low, this bit inhibits the interrupt indicating that the system is ready for a new command.  
When high, this bit enables the interrupt.
- Bit 7 : Not used. Always low in read mode.

**CTRL2 REGISTER** (Address :  $2_{16}$ )

The CTRL2 register is a 4-bit read/write register, through which the plotting of vectors and characters may be denoted by parameters.

- Bit 0, 1 : These 2 bits define 4 types of lines (continuous, dotted, dashed, dash-dotted).
- Bit 2 : When low, this bit defines straight writing.  
When high, it defines tilted characters.
- Bit 3 : When low, this bit defines writing along an horizontal line.  
When high, this bit defines writing along a vertical line.
- Bit 4, 5, 6, 7 : Not used. Always low in read mode.

**CMD COMMAND REGISTER** (Address : 0<sub>16</sub>)

The CMD register is an 8-bit write-only register. Each write operation in this register causes a command to be executed, upon completion of the time necessary for synchronizing the microprocessor access and the GDP's CK clock.

Several types of command are available :

- vector plotting
- character plotting
- screen erase
- light pen circuitry setting
- access to the display memory through an external circuitry.
- indirect modification of the other registers (commands that make it possible for the X, Y, DELTAX, DELTAY, CTRL1, CTRL2 and CSIZE registers to be amended or scratched).

**STATUS REGISTER** (Address 0<sub>16</sub>)

The STATUS register is an 8-bit read-only register. It is used to monitor the status of the executing statements entered into the circuit, and more specifically to avoid the need for modifying a register that is already used for the command currently executing.

- Bit 0 : When low, this bit indicates that a light pen sequence is currently executing.  
When high, it indicates that no light pen sequence is currently executing.
- Bit 1 : This bit is high during vertical blanking. It is the VB signal recopy.
- Bit 2 : When low, this bit indicates that a command is currently executing.  
When high, this bit indicates that the circuit is ready for a new command.
- Bit 3 : When low, this bit indicates that the X and Y registers point within the display window.  
When high, this bit indicates that the X and Y registers are pointing outside the memory display.  
This bit is the logic OR of the unused MSBs of the X and Y registers.
- Bit 4 : When high, this bit indicates that an interrupt has been initiated by the completion of a light pen running sequence. Such an interrupt is enabled by bit 4 in CTRL1 register.
- Bit 5 : When high, this bit indicates that an interrupt has been initiated by vertical blanking. Such an interrupt is enabled by bit 5 in CTRL1 register.

Bit 6 : When high, this bit indicates that an interrupt has been initiated by the completion of execution of a command. Such an interrupt is enabled by bit 6 in CTRL1 register.

Bit 7 : When high, this bit indicates that an interrupt has been initiated. It is the logic OR of bits 4, 5 and 6 in STATUS register. The  $\overline{IRQ}$  output state is always the opposite of the status of this bit.

**Note :** Bits 4, 5, 6 and 7 are reset low by a read of the STATUS register.

**XLP AND YLP REGISTERS** (Addresses C<sub>16</sub> and D<sub>16</sub>)

The XLP and YLP registers are read-only registers, with 7 and 8 bits respectively. Upon completion of a light pen running sequence, they contain the display address sampled by the first edge appearing rising on the LPCK input. The use of such registers is discussed in section : **Use of light pen circuitry.**

**NOTES :**

1. All internal registers may be read or written at any time by the microprocessor. However, the precautions outlined below should be observed :
  - Do not write into the CMD register if execution of the previous command is not completed (bit 2 of STATUS register).
  - Do not alter any register if it is used as an input parameter for the internal hardwired systems (e. g. : modifying the DELTAX register while a vector plotting sequence is in progress).
  - Do not read a register that is being asynchronously modified by the internal hardwired systems (e. g. : reading the X register while a vector plotting sequence is in progress may be erroneous if CK and  $\overline{E}$  are asynchronous).
2. On powering up, the writing devices may have any status. Before entering a command for the first time, it is necessary to wait until all functions currently underway are completed, which information can be derived from the STATUS register.

## SYSTEM OPERATING PRINCIPLE

### DISPLAY MEMORY CONFIGURATION

Assume a  $V \times H$  pixel picture. Assume that each pixel is able to adopt  $2^b$  different states. A  $V \times H \times b$  bit display memory is thus required.

In those applications where  $H$  features a high value, the video signal frequency exceeds the maximum frequency of memory read access.

Example :  $H = 512$  with a television line frequency : the pixel succession period on the video signal is 70 ns.

It is mandatory that a line of  $H$  dots be cut into  $h$  adjoining segments of  $n$  bits each, read at the same time in the display memory, and thereafter converted to serial form to produce the video signal.  $h$  memory accesses per line are necessary. Each access loads  $b$   $n$ -bit shift registers. The memory contains  $V \times h \times b$   $n$ -bit words.

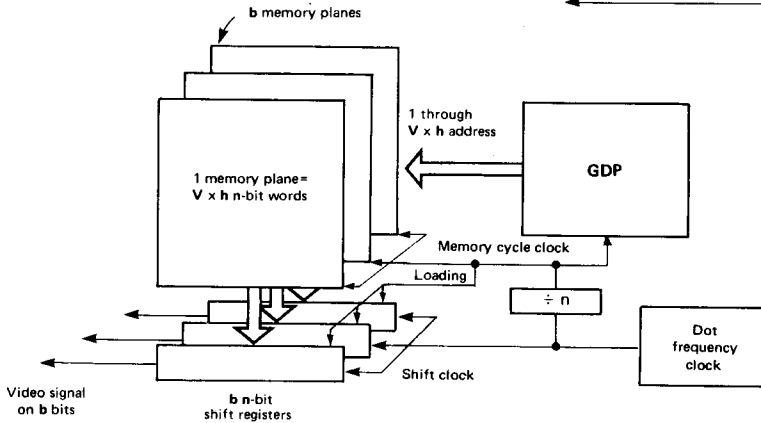
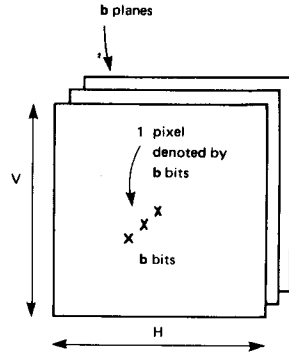

#### EF9365

The EF9365 circuit is designed to accommodate the following picture formats :

1.  $V = H = 512$  or a lower power of 2
2.  $h = 64$
3.  $n = 8, 4, 2$  or 1
4. Any value for  $b$  (the addressing is similar for all memory planes. These planes are managed outside the actual circuit).

Circuit operation in the various formats outlined above occurs as described below :

#### 512 x 512 pixel format ( $V = 512, h = 64, n = 8$ )

The FMAT input should be high. The memory is made up of  $V \times h$  bytes = 32 K bytes per memory plane.

The byte address is made up of 15 bits :

- 14 are output in 2 runs on the DAD pins for the purpose of using 16 K x 1 bit dynamic RAMs,
- the 15th one is output on pin MSL3.

The 3 MSL0, 1 and 2 outputs allow to select one pixel out of the 8 featuring the same address, for pixel-to-pixel write applications. They issue the number of the involved pixel, encoded on 3 bits.

#### 256 x 256 pixel format ( $V = 256, h = 64, n = 4$ )

The FMAT input should be low. The memory is made up of  $V \times h \times n$  bits, i.e. 16 K 4-bit words. The address of a 4-bit word is made up of 14 bits, which are output in 2 runs on the DAD pins.

Each of the 4 MSL pins is used to select one pixel in a 4-bit word for writing purposes. The 2 LSBs in the horizontal writing address are decoded before being output on the MSL pins. Such outputs are active when low.

#### Format less than 256 x 256 pixels ( $V = 128$ or $64, h = 64, n = 2$ or 1).

Such formats are achieved in the same way as for the 256 x 256 pixel format discussed above. Unrequired address bits are output on DAD7.

**EF9366**

The EF9366 circuit is designed to accommodate a (512 x 256) picture format : V = 256, H = 512, h = 64, n = 8, b = any value.

The memory is made up of 16 K bytes per memory plane. The byte address is made up of 14 bits which are output in two runs on the DAD pins. The 3 MSL0, MSL1, MSL2 outputs are used to select one pixel out of the 8 featuring the same address. They issue the number of the pixel, encoded on 3 bits. MSL3 is high, and is not used.

**SIGNALS OUTPUT THROUGH THE DAD AND MSL PINS**

The internal counters which address the display memory are made up of :

- 6 horizontal address bits (h = 64)  
h<sub>0</sub>, h<sub>1</sub>, h<sub>2</sub>, h<sub>3</sub>, h<sub>4</sub>, h<sub>5</sub>
- 9 vertical address bits (V ≤ 512)  
t, V<sub>0</sub>, V<sub>1</sub>, V<sub>2</sub>, V<sub>3</sub>, V<sub>4</sub>, V<sub>5</sub>, V<sub>6</sub>, V<sub>7</sub>

t is here the LSB. It denotes the line parity and changes every frame because of interlaced scan. Within a same frame, V<sub>0</sub> denotes the LSB.

The write address is made up of the 9 LSBs of the X and Y internal registers.

$$X_0, X_1, X_2, X_3, X_4, X_5, X_6, X_7, X_8$$

$$Y_0, Y_1, Y_2, Y_3, Y_4, Y_5, Y_6, Y_7, Y_8$$

The display address and write address are cross-referenced as follows :

**EF9365**

FMAT = 1

h <sub>0</sub>	h <sub>1</sub>	h <sub>2</sub>	h <sub>3</sub>	h <sub>4</sub>	h <sub>5</sub>	t	V <sub>0</sub>	V <sub>1</sub>	V <sub>2</sub>	V <sub>3</sub>	V <sub>4</sub>	V <sub>5</sub>	V <sub>6</sub>	V <sub>7</sub>
X <sub>3</sub>	X <sub>4</sub>	X <sub>5</sub>	X <sub>6</sub>	X <sub>7</sub>	X <sub>8</sub>	Y <sub>0</sub>	Y <sub>1</sub>	Y <sub>2</sub>	Y <sub>3</sub>	Y <sub>4</sub>	Y <sub>5</sub>	Y <sub>6</sub>	Y <sub>7</sub>	Y <sub>8</sub>

FMAT = 0

h <sub>0</sub>	h <sub>1</sub>	h <sub>2</sub>	h <sub>3</sub>	h <sub>4</sub>	h <sub>5</sub>	V <sub>0</sub>	V <sub>1</sub>	V <sub>2</sub>	V <sub>3</sub>	V <sub>4</sub>	V <sub>5</sub>	V <sub>6</sub>	V <sub>7</sub>
X <sub>2</sub>	X <sub>3</sub>	X <sub>4</sub>	X <sub>5</sub>	X <sub>6</sub>	X <sub>7</sub>	Y <sub>0</sub>	Y <sub>1</sub>	Y <sub>2</sub>	Y <sub>3</sub>	Y <sub>4</sub>	Y <sub>5</sub>	Y <sub>6</sub>	Y <sub>7</sub>

**EF9366**

h <sub>0</sub>	h <sub>1</sub>	h <sub>2</sub>	h <sub>3</sub>	h <sub>4</sub>	h <sub>5</sub>	V <sub>0</sub>	V <sub>1</sub>	V <sub>2</sub>	V <sub>3</sub>	V <sub>4</sub>	V <sub>5</sub>	V <sub>6</sub>	V <sub>7</sub>
X <sub>3</sub>	X <sub>4</sub>	X <sub>5</sub>	X <sub>6</sub>	X <sub>7</sub>	X <sub>8</sub>	Y <sub>0</sub>	Y <sub>1</sub>	Y <sub>2</sub>	Y <sub>3</sub>	Y <sub>4</sub>	Y <sub>5</sub>	Y <sub>6</sub>	Y <sub>7</sub>

**DAD AND MSL OUTPUT STATUS TABLES**

**EF9365 FMAT = 1**

ALL	CK	MSL				DAD						
		0	1	2	3	0	1	2	3	4	5	6
0	0	X <sub>0</sub>	X <sub>1</sub>	X <sub>2</sub>	V <sub>1</sub>	h <sub>5</sub>	h <sub>4</sub>	h <sub>3</sub>	h <sub>2</sub>	h <sub>1</sub>	h <sub>0</sub>	V <sub>0</sub>
0	1					V <sub>7</sub>	V <sub>6</sub>	V <sub>5</sub>	V <sub>4</sub>	V <sub>3</sub>	V <sub>2</sub>	t
1	0	X <sub>0</sub>	X <sub>1</sub>	X <sub>2</sub>	Y <sub>2</sub>	X <sub>8</sub>	X <sub>7</sub>	X <sub>6</sub>	X <sub>5</sub>	X <sub>4</sub>	X <sub>3</sub>	Y <sub>1</sub>
1	1					Y <sub>8</sub>	Y <sub>7</sub>	Y <sub>6</sub>	Y <sub>5</sub>	Y <sub>4</sub>	Y <sub>3</sub>	Y <sub>0</sub>

**EF9365 FMAT = 0**

ALL	CK	MSL				DAD						
		0	1	2	3	0	1	2	3	4	5	6
0	0	0	0	0	0	h <sub>5</sub>	h <sub>4</sub>	h <sub>3</sub>	h <sub>2</sub>	h <sub>1</sub>	h <sub>0</sub>	V <sub>0</sub>
0	1					V <sub>7</sub>	V <sub>6</sub>	V <sub>5</sub>	V <sub>4</sub>	V <sub>3</sub>	V <sub>2</sub>	V <sub>1</sub>
1	0	X <sub>0</sub> and X <sub>1</sub> decoded (active low)				X <sub>7</sub>	X <sub>6</sub>	X <sub>5</sub>	X <sub>4</sub>	X <sub>3</sub>	X <sub>2</sub>	Y <sub>0</sub>
1	1					Y <sub>7</sub>	Y <sub>6</sub>	Y <sub>5</sub>	Y <sub>4</sub>	Y <sub>3</sub>	Y <sub>2</sub>	Y <sub>1</sub>

If FMAT is high, the 128 refresh accesses are executed at 2 line intervals, for only one half of the memory, the 32 K-bytes being split into two 16 K-byte blocks. The V<sub>1</sub> output on MSL3 is used to switch over from one block to the other at 2 line intervals. During vertical blanking, such a refresh is achieved using 4 lines at 16 line intervals.

**EF9366**

ALL	CK	MSL				DAD						
		0	1	2	3	0	1	2	3	4	5	6
0	0	X <sub>0</sub>	X <sub>1</sub>	X <sub>2</sub>	1	h <sub>5</sub>	h <sub>4</sub>	h <sub>3</sub>	h <sub>2</sub>	h <sub>1</sub>	h <sub>0</sub>	V <sub>0</sub>
0	1				1	V <sub>7</sub>	V <sub>6</sub>	V <sub>5</sub>	V <sub>4</sub>	V <sub>3</sub>	V <sub>2</sub>	V <sub>1</sub>
1	0				1	X <sub>8</sub>	X <sub>7</sub>	X <sub>6</sub>	X <sub>5</sub>	X <sub>4</sub>	X <sub>3</sub>	Y <sub>0</sub>
1	1				1	Y <sub>7</sub>	Y <sub>6</sub>	Y <sub>5</sub>	Y <sub>4</sub>	Y <sub>3</sub>	Y <sub>2</sub>	Y <sub>1</sub>

If FMAT is low or for the EF9366 : the 128 refresh accesses are executed at 2 display line intervals.

## MEMORY OPERATION SEQUENCE ALONG ONE FRAME

Apart from the window where the memory is used for display purposes exclusively, write operations may be performed, except during 3 refresh periods.

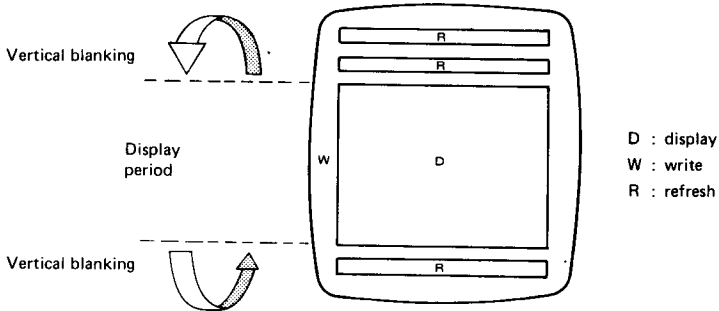

The three period types, D, W and R, respectively, are indicated outside the circuit through the BLK and ALL signals :

	BLK	ALL
D	0	0
W	1	1
R	1	0

### Exceptions :

- If bit 2 in register CTRL1 is high (high speed write), the display period is suppressed and 19 refresh cycles of 4 lines each are executed during one frame.
- As long as the WO input is high, the circuit is set to write mode, and BLK retains the same outline as it has under normal operating conditions.

In these two cases, executing codes  $04_{16}$ ,  $06_{16}$ ,  $07_{16}$  and  $0C_{16}$  triggers a complete D sequence for a high-speed scan of all addresses. This lasts two frames if FMAT is high or one frame if FMAT is low and for the EF9366 version.



COMPOSITE SYNC AROUND FRAME SYNC

T : CK input period (570 ns in a typical application)

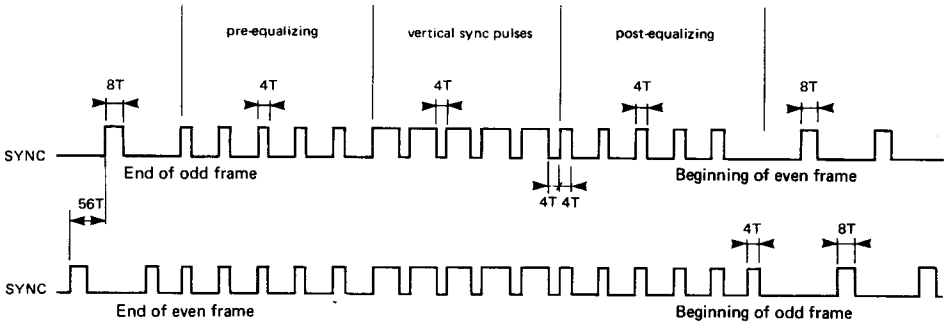

Note : If FMAT is low and for the EF9366 version, the pattern of the second line is repeated for each frame.

DETAILED LINE DIAGRAM

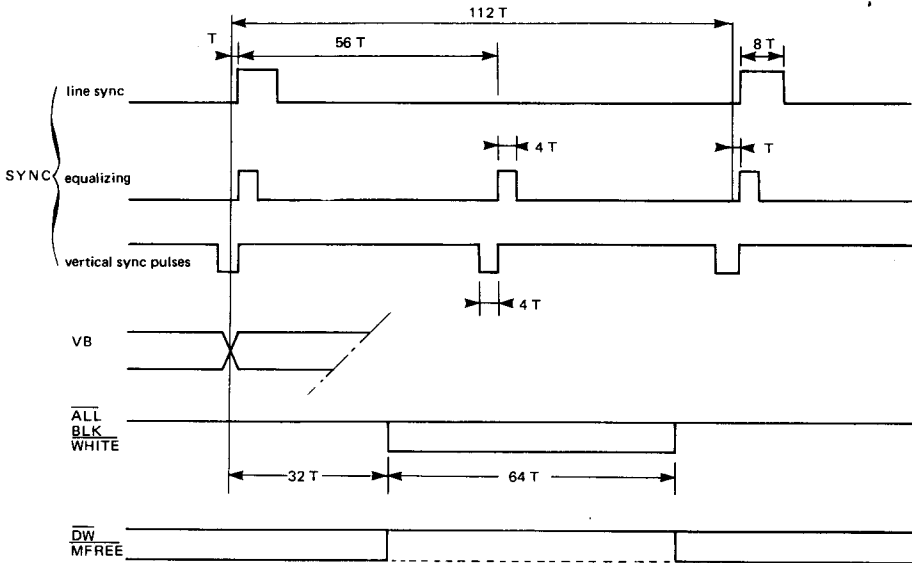

**HARDWIRED WRITE PROCESSOR OPERATION IN DISPLAY MEMORY**

The hardwired write processors are sequenced by the, master clock CK. They receive their parameters from the microprocessor bus. They control the X, Y write address, and the DIN, DW, MFREE and IRQ outputs.

These harwired processors operate in continuous mode. In the event of conflicting access to the display memory, the display and refresh processors have priority.

Since command decoding is synchronous with the CK master clock, any write operation into the (CMD) command register triggers a synchronizing mechanism which engages the circuit for a maximum of 2 CK cycles when the E input returns high. The circuit remains engaged throughout command execution.

No further command should be entered as long as bit 2 in STATUS register is low.

**VECTOR PLOTTING**

The internal vector generator makes it possible to modify, within the display memory, all the dots which form the approximation of a straight line segment. All vectors plotted are described by the origin dot and the projections on the axes.

The starting point co-ordinates are defined by the X, Y register value, prior to the plotting operation. Projections, onto the axes are defined as absolute values by the DELTAX and DELTAY registers, with the sign in the command byte that initiates the vector plotting process.

The vector approximation achieved here is that established by J. F. BRESENHAM ("Algorithm for computer control of a digital plotter"). This algorithm is executed by a hardwired processor which allows for a further vector component dot to be written in each CK clock cycle.

During plotting, the display memory is addressed by the X, Y registers, which are incremented or decremented.

On completion of vector plotting, they point to the end of this vector.

All vectors may be plotted using any of the following line patterns : continuous, dotted, dashed, dash-dotted, according to the 2 LSBs in register CTRL2.

Irrespective of such patterns, the plotting speed remains unchanged. The "pen down-pen up" statement required for plotting non-continuous lines is controlled by the DW output.

For a specified non-continuous line plotted vector, defined by DELTAX, DELTAY, CTRL2, CMD, the DW sequencing during the plotting process is always the same, irrespective of vector origin and of the nature of previous plots. This feature guarantees that a specified vector can be deleted by plotting it again after moving X and Y to the starting point, and complementing bit 1 in register CTRL1.

Since the vector plotting initiation command defines the sign of the projections onto the axes, all vectors may be plotted using 4 different commands.

For increased programming flexibility, the system incorporates 16 different commands, supplemented by a set of 128 commands which make it possible to plot small size vectors by ignoring the DELTAX and DELTAY registers.

Such commands are as follows :

- Basic commands

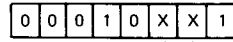

DELTA X sign } 0 if positive  
 DELTA Y sign } 1 if negative

- Commands which allow ignoring the DELTAX or DELTAY registers by considering them as of zero value.

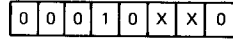

0 0 DELTAY ignored, DELTAX > 0  
 0 1 DELTAX ignored, DELTAY > 0  
 1 0 DELTAX ignored, DELTAY < 0  
 1 1 DELTAY ignored, DELTAX < 0

Note : Bits 1 and 2 always have the same sign meaning.

These 8 codes may be summarized by the following diagram :

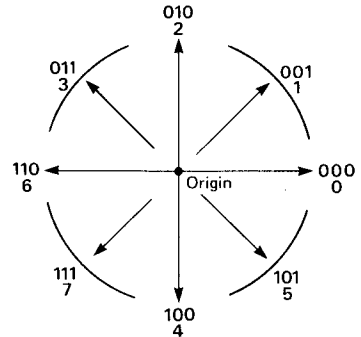

- Commands which allow ignoring the smaller of the two DELTAX and DELTAY registers, by considering it as being equal to the larger one, which is the same as plotting vectors parallel to the axes or diagonals, using a single DELTA register.

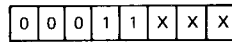

Same direction codes as above.

- Commands in which the two registers DELTAX and DELTAY may be ignored by specifying the projections through the CMD register (0 to 3 steps for each projection).

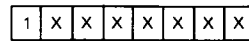

$\Delta X$   $\Delta Y$   
 (Unsigned integer values) Same direction code as previously



**EXAMPLE : PLOTTING A DOTTED VECTOR**

Origin :  $\begin{cases} X = 47_{10} \\ Y = 75_{10} \end{cases}$

CMD =  $13_{16}$

Corresponding to  
 - Basic command,  
 - DELTAX < 0  
 - DELTAY > 0

Projections:  $\begin{cases} \text{DELTAX} = 17_{10} \\ \text{DELTAY} = 13_{10} \end{cases}$

CTRL1 =  $03_{16}$

Pen down

CTRL2 =  $1_{16}$

Dotted vector :  
 2 dots on,  
 2 dots off.

**Plotting cycle sequence :** (It is assumed that the vector generator is not interrupted by the display or refresh cycle).

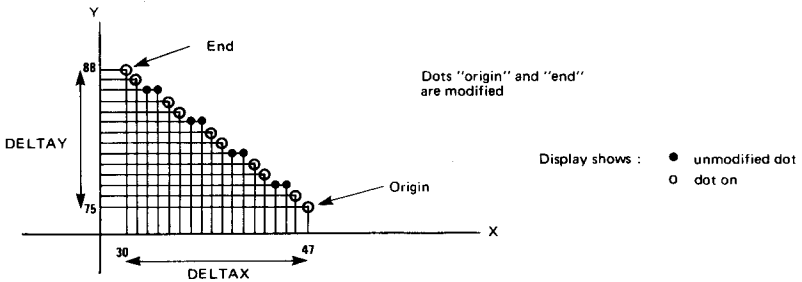
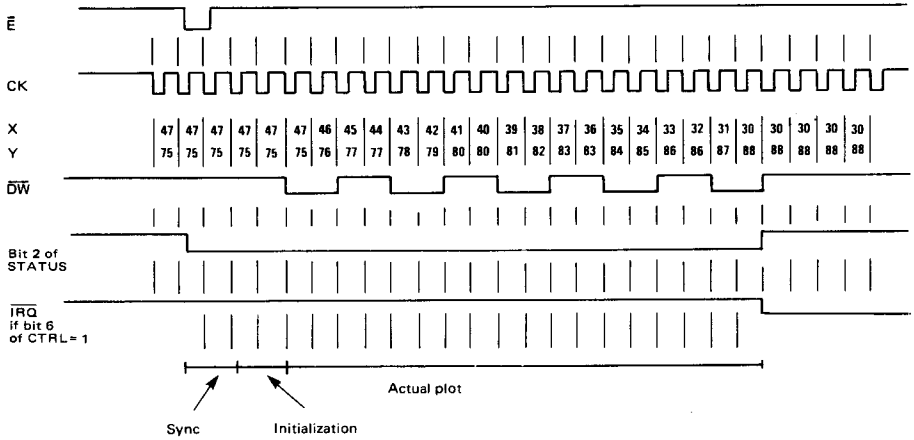

**Note :**

Plotting a vector with DELTAX = DELTAY = 0 writes the dot X, Y in memory. It occupies the vector generator for synchronization, initialization and one write cycle.

**CHARACTER AND SYMBOL GENERATOR**

The character generator operates in the same way as the vector generator, i.e. through incrementing or decrementing the X, Y registers, in conjunction with a DW output control.

It receives parameters from the CSIZE, CTRL2 and CMD registers. The characters plotted are selected, according to the CMD value, out of 98 matrices (97 8-dot high x 5-dot wide rectangular matrices, and one 4 dot x 4 dot matrix) defined in an internal ROM. Two scaling factors may be applied to the characters plotted using X and Y defined by the CSIZE register. The characters may be tilted, according to the content of register CTRL2.

**Basic matrix**

Upon completion of a character writing process, the X and Y registers are positioned for writing a further character next to the previous one, with a 1 dot spacing, i.e. Y is restored to its original value and X is incremented by 6.

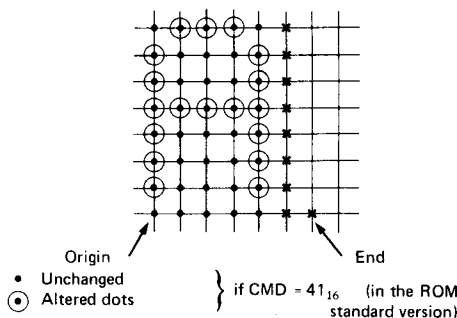

**Scaling factors**

Each individual dot in the 5 x 8 basic matrix may be replaced by a P x Q size block.

- P : X co-ordinate scaling factor
- Q : Y co-ordinate scaling factor

The character size becomes 5P x 8Q. Upon completion of the writing process, X is incremented by 6P. The CK clock cycle count required is 6P x 8Q.

**USE OF LIGHT PEN CIRCUITRY**

A rising edge on the LPCK input is used to sample the current display address in the XLP and YLP registers, provided that this edge is present in the frame immediately following loading of the 0B<sub>16</sub> or 09<sub>16</sub> code into the CMD register.

Here, the frame origin is counted starting with the VB falling edge: With code 0B<sub>16</sub>, the WHITE output recopies the BLK signal from the frame origin up to the rising edge on the LPCK input, or when VB starts rising again, if the LPCK input remains low for the entire frame. With code

P and Q may each take values from 1 through 16. They are defined by the CSIZE register. Each value is encoded on 4 bits, value 16 being encoded as 0<sub>16</sub>.

In register CSIZE, P is encoded on the 4 MSBs and Q on the 4 LSBs.

Among the 97 rectangular matrices available in the standard ROM, 96 correspond to CMD values ranging from 20<sub>16</sub> to 7F<sub>16</sub>, and the 97th matrix to 0A<sub>16</sub>. In the standard version, these values correspond to the 96 printable characters in the ASCII set. The 97th character is a 5P x 8Q block which may be used for deleting the other characters.

The 98th code (0B<sub>16</sub>) is used to plot a 4P x 4Q graphic block. It locates X, Y, without spacing for the next symbol. Such a block makes it possible to pad uniform areas on the screen.

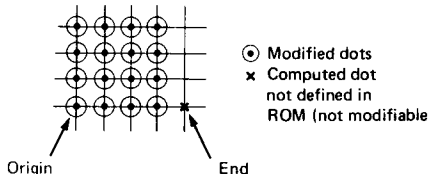

**Tilted characters**

All characters may be modified to produce tilted characters or to mark the vertical co-ordinate with straight or tilted type symbols. Such changes may be achieved using bits 2 and 3 in register CTRL2.

**Note :** Scaling factors P and Q are always applied within the co-ordinates of the character before conversion.

**Character deletion**

A character may be deleted using either the same command code or command code 0A<sub>16</sub>. In either case, bit 1 in register CTRL1 should be inverted, the origin should be the same as prior to a character plotting operation, as should the scaling factors.

**Note :** Vector generator and character generator operate in similar ways :

	VECTOR	CHARACTER
Dimensions	DELTA X, DELTA Y	CSIZE, tilting
DW modulation	Type of line	Character code

09<sub>16</sub>, the WHITE output is not activated.

The YLP address is 8-bit coded since there are 256 display lines in each frame. The XLP address is 6-bit coded since there are 64 display cycles in each line.

These 6 bits are left justified in the XLP register. XLP and YLP register contents match the write address if FMAT is low (or for the EF9366), but should be multiplied by 2 if FMAT is high, so as to be able to match the write address.

The address sampled into XLP corresponds to the current memory cycle. Dots detected by the light pen were addressed in the memory during the previous cycle. Hence, 1 should be subtracted from bit 2 in XLP register where the light pen electronic circuitry does not produce any additional delay.

If the rising edge on input LPCK occurs while VB is low, then the LSB in XLP is set high. This bit acts as a status signal which is reset to the low state by reading register XLP or YLP.

### SCREEN BLANKING COMMANDS

Three commands ( $04_{16}$ ,  $06_{16}$ ,  $07_{16}$ ) will set the whole display memory to a status corresponding to a "black display screen" condition. Another command ( $0C_{16}$ ) may be used to set the whole memory to a status other than black (this condition being determined by bit 1 in register CTRL1).

The 4 commands outlined above use the planned scanning of the memory addresses achieved by the display stage. The X and Y registers are not affected by commands  $04_{16}$  and  $0C_{16}$ . Hence, the time required is that corresponding to one frame (EF9366 or FMAT low) or two frames (FMAT high). The time corresponding to the completion of the

frame currently executing when the CMD register is loaded, should be added to the above time.

For the screen blanking process, the frame origin is counted starting with the VB falling edge.

The only signals affected here are the  $\overline{DW}$  output, which remains low when VB is low, and the DIN output which is forced high where the  $04_{16}$ ,  $06_{16}$  and  $07_{16}$  commands are entered.

Such commands are activated without requiring action by WO input or bit 2 in register CTRL1. While these commands are executing, bit 2 in STATUS register remains low.

### EXTERNAL REQUEST FOR DISPLAY MEMORY ACCESS ( $\overline{MFREE}$ OUTPUT)

On writing code  $0F_{16}$  into the CMD register, the  $\overline{MFREE}$  output is set low by the circuitry, during the next free memory cycle.

Apart from the display and refresh periods, this cycle is the first complete cycle that occurs after input  $\overline{E}$  is reset high.

During this cycle, those addresses output on DAD and MSL correspond to the X and Y register contents:  $\overline{DW}$  is high, ALL is high.

Should the memory be engaged in a display or refresh operation, (which is the case when ALL is low), then this cycle is postponed to be executed after ALL is reset high. The maximum waiting time is thus 64 cycles.

The  $\overline{MFREE}$  signal may be used e. g. for performing a read or write operation into a register located between the display memory and the microprocessor bus.

### INTERRUPTS OPERATION

An interrupt may be initiated by three situations denoted by internal signals:

- Circuit ready for a further command
- Vertical blanking signal
- Light pen sequence completed.

These three signals appear in real time in the STATUS register (bits 0, 1, 2). Each signal is cross-referenced to a mask bit in the register CTRL1 (bits 4, 5, 6).

If the mask bit is high, the first rising edge that occurs on the interrupt initiating signal sets the related interrupt flip-flop circuit high.

The outputs from these three flip-flop circuits appear in the STATUS register (bits 4, 5, 6). If one flip-flop circuit

is high, bit 7 in the STATUS register is high, and pin  $\overline{IRQ}$  is forced low.

A read operation in the STATUS register resets its 4 MSBs low, after input  $\overline{E}$  is reset high.

The three interrupt control flip-flops are duplicated to prevent the loss of an interrupt coming during a read cycle of the STATUS register.

The status of bits 4, 5 and 6 corresponds to the interrupt control flip-flop circuit output, before input  $\overline{E}$  goes low.

An interrupt coming during a read cycle of the STATUS register does not appear in bits 4, 5 and 6 during this read sequence, but during the following one. However, it may appear in bits 0, 1, 2 or on pin  $\overline{IRQ}$ .

TABLE 1 — REGISTER ADDRESS

ADDRESS REGISTER					REGISTER FUNCTIONS		Number of bits
Binary				Hexa	Read R/W = 1	Write R/W = 0	
A3	A2	A1	A0				
0	0	0	0	0	STATUS	CMD	8
0	0	0	1	1	CTRL 1 (Write control and interrupt control)		7
0	0	1	0	2	CTRL 2 (Vector and symbol type control)		4
0	0	1	1	3	CSIZE (Character size)		8
0	1	0	0	4	Reserved		—
0	1	0	1	5	DELTA X		8
0	1	1	0	6	Reserved		—
0	1	1	1	7	DELTA Y		8
1	0	0	0	8	X MSBs		4
1	0	0	1	9	X LSBs		8
1	0	1	0	A	Y MSBs		4
1	0	1	1	B	Y LSBs		8
1	1	0	0	C	XLP (Light-pen)	Reserved	7
1	1	0	1	D	YLP (Light-pen)	Reserved	8
1	1	1	0	E	Reserved		—
1	1	1	1	F	Reserved		—

Reserved : These addresses are reserved for future versions of the circuit. In read mode, output buffers D0-D7 force a high state on the data bus.

TABLE 2 — COMMAND REGISTER

b7 b6 b5 b4	b3 b2 b1 b0	Description	Vector generation (for b2, b1, b0 see small vector definition)															
			0	0	0	0	0	0	0	0	0	1	1	1	1	1	1	1
			1	2	3	4	5	6	7	8	9	A	B	C	D	E	F	
0	0	0	0	0	0	0	0	0	0	0	1	1	1	1	1	1	1	
0	0	0	0	1	1	1	0	0	1	1	0	0	1	1	0	0	1	
0	0	1	0	2	2	B	R	b	r	0	1	0	1	0	1	0	1	
0	0	1	1	3	#	3	C	S	c	s	0	1	0	1	0	1	0	1
0	1	0	0	4	\$	4	D	T	d	t	0	1	0	1	0	1	0	1
0	1	0	1	5	%	5	E	U	e	u	0	1	0	1	0	1	0	1
0	1	1	0	6	&	6	F	V	f	v	0	1	0	1	0	1	0	1
0	1	1	1	7	'	7	G	W	g	w	0	1	0	1	0	1	0	1
1	0	0	0	8	(	8	H	X	h	x	0	1	0	1	0	1	0	1
1	0	0	1	9	)	9	I	Y	i	y	0	1	0	1	0	1	0	1
1	0	1	0	A	*	:	J	Z	j	z	0	1	0	1	0	1	0	1
1	0	1	1	B	+	:	K	[	k	{	0	1	0	1	0	1	0	1
1	1	0	0	C	,	<	L	\	l	!	0	1	0	1	0	1	0	1
1	1	0	1	D	-	=	M	]	m	}	0	1	0	1	0	1	0	1
1	1	1	0	E	.	>	N	^	n	~	0	1	0	1	0	1	0	1
1	1	1	1	F	/	?	O	~	o	⊠	0	1	0	1	0	1	0	1

**SMALL VECTOR DEFINITION :**

b7	b6	b5	b4	b3	b2	b1	b0
1	ΔX	ΔY	Direction				

**Dimension**

ΔX or ΔY	Vector length
0 0	0 step
0 1	1 step
1 0	2 steps
1 1	3 steps

**Direction**

## OTHER REGISTERS

### STATUS REGISTER (Read only)

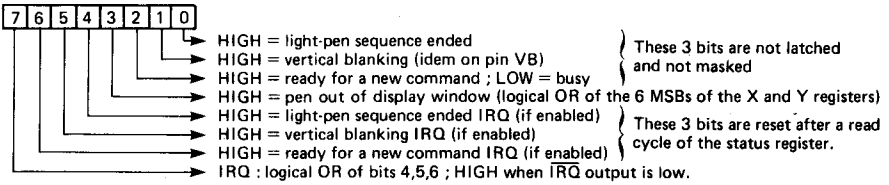

### CONTROL REGISTER 1 (Read/Write)

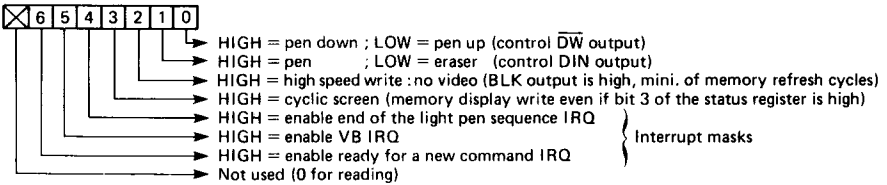

### CONTROL REGISTER 2 (Read/Write)

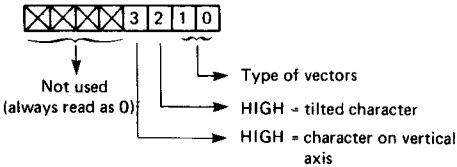

b1	b0	Type of vectors	
0	0	———— continuous	
0	1	----- dotted	2 dots on, 2 dots off
1	0	- - - - - dashed	4 dots on, 4 dots off
1	1	- . - . - dotted-dashed	10 dots on, 2 dots off, 2 dots on, 2 dots off.

### Types of character orientations

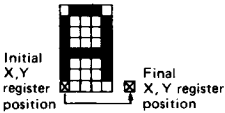

$b_3 = 0, b_2 = 0$   
CSIZE =  $11_{16}$

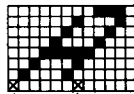

$b_3 = 0, b_2 = 1$   
CSIZE =  $11_{16}$

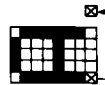

$b_3 = 1, b_2 = 0$   
CSIZE =  $11_{16}$

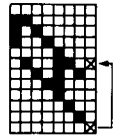

$b_3 = 1, b_2 = 1$   
CSIZE =  $11_{16}$

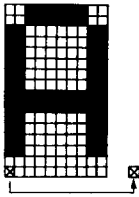

$b_3 = 0, b_2 = 0$   
CSIZE =  $22_{16}$

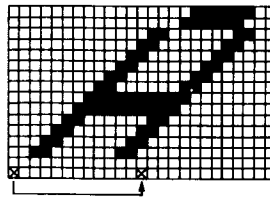

$b_3 = 0, b_2 = 1$   
CSIZE =  $22_{16}$

**C-SIZE REGISTER (Read/Write)**

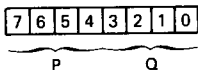

P : Scaling factor on X axis  
 Q : Scaling factor on Y axis

P and Q may take any value between 1 and 16. This value is given by the leftmost or rightmost 4 bits for P and Q respectively. Binary value (0) means 16.

**X AND Y REGISTERS (Read/Write)**

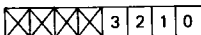

MSBs

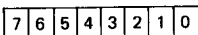

LSBs

The 4 leftmost MSBs are always 0.

**XLP and YLP REGISTERS**

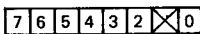

Status bit indicating if a rising edge has been applied on LPCK during the first complete frame following light-pen initialization. This bit is reset by a read on XLP or YLP.

always 0

6 bit XLP value

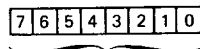

8 bit YLP value

ASCII CHARACTER GENERATOR (5 x 8 matrix)

b7	0	0	0	0	0	0
b6	0	0	1	1	1	1
b5	1	1	0	0	1	1
b4	0	1	0	1	0	1

b3	b2	b1	b0						
0	0	0	0						
0	0	0	1						
0	0	1	0						
0	0	1	1						
0	1	0	0						
0	1	0	1						
0	1	1	0						
0	1	1	1						
1	0	0	0						
1	0	0	1						
1	0	1	0						
1	0	1	1						
1	1	0	0						
1	1	0	1						
1	1	1	0						
1	1	1	1						

EXAMPLE OF AN APPLICATION OF THE EF9365 : 256 x 256 BLACK AND WHITE

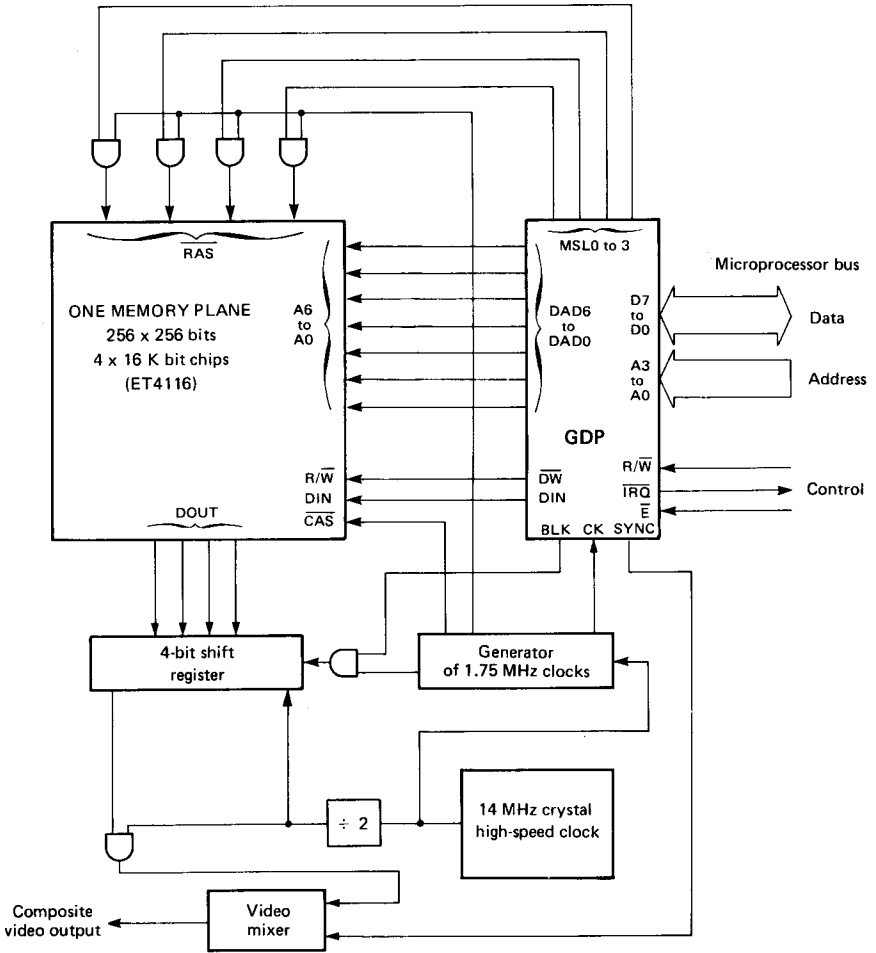

Note : FMAT = V<sub>SS</sub>



EXAMPLE OF AN APPLICATION OF THE EF9365 : 512 x 512 BLACK AND WHITE

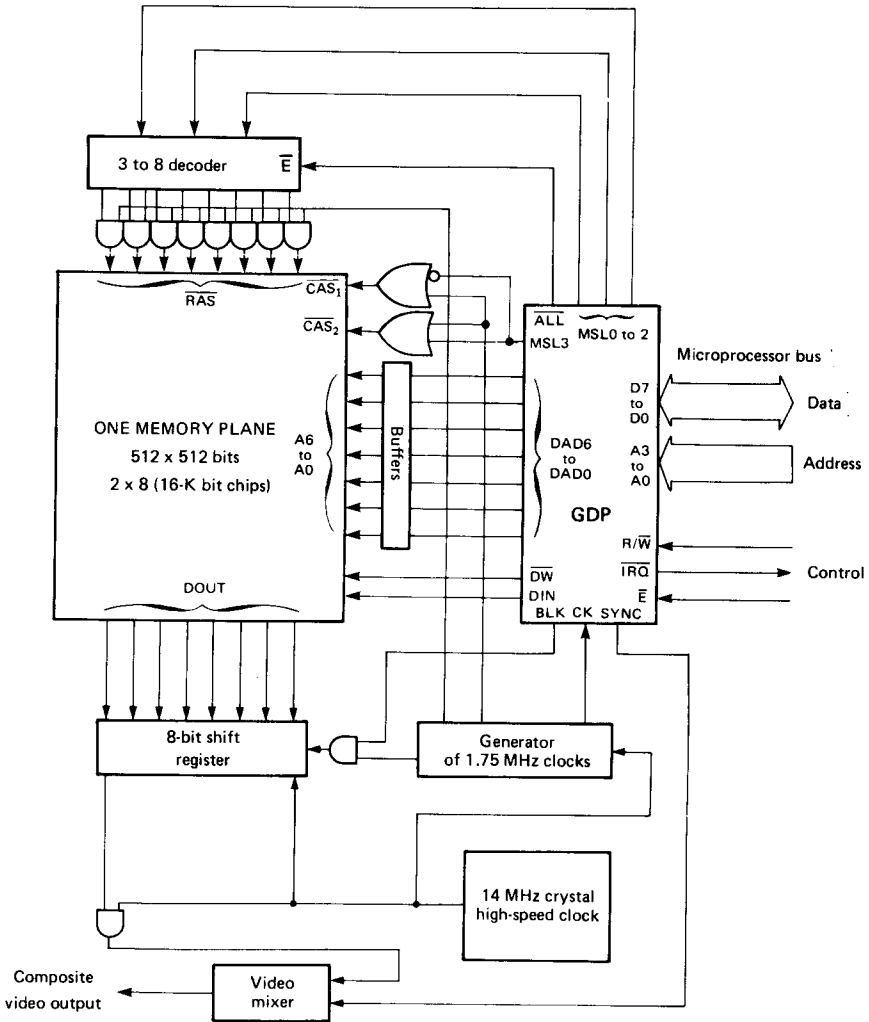

Note : FMAT = V<sub>CC</sub>

**EXAMPLE OF AN APPLICATION OF THE EF9366 : 256 x 512 COLOUR**

Eight colours may be obtained from the three basic colours red (R), green (G), blue (B)

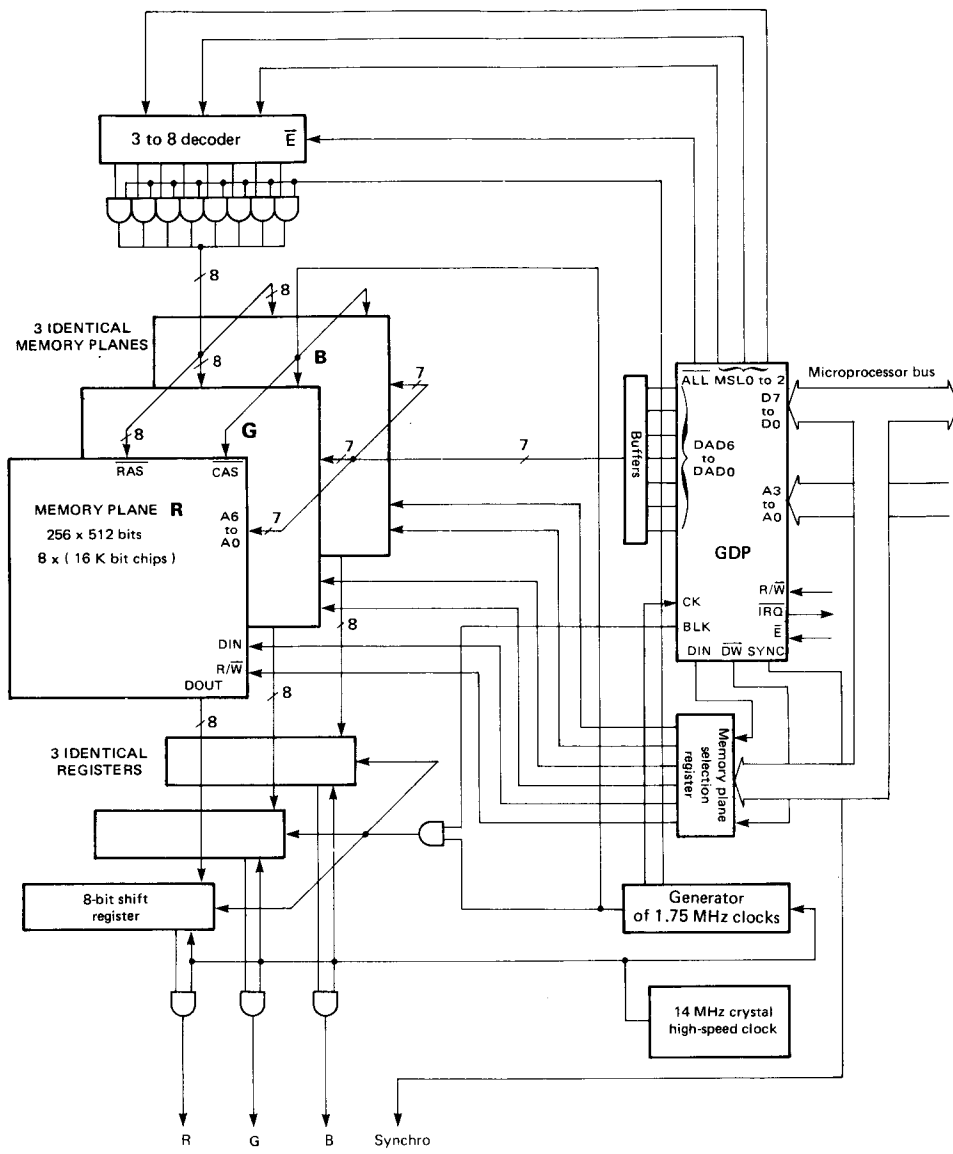

Note : FMAT = VCC

CASE CB-182

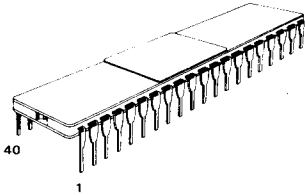

**C SUFFIX**  
CERAMIC PACKAGE

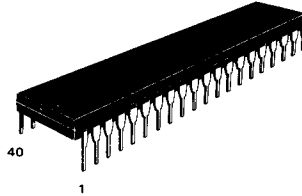

**P SUFFIX**  
PLASTIC PACKAGE

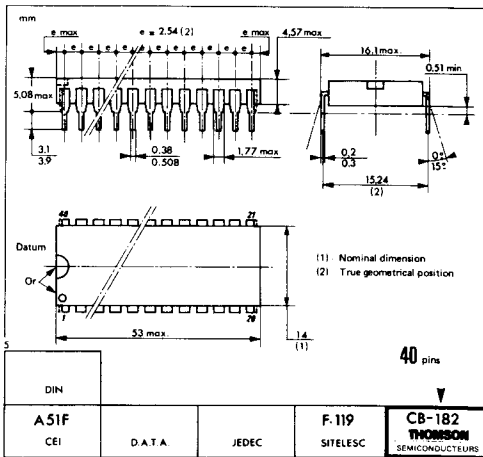

These specifications are subject to change without notice.  
Please inquire with our sales offices about the availability of the different packages.

---

NOTES

---