

BCR3KM

LOW POWER USE

INSULATED TYPE, PLANAR PASSIVATION TYPE

Refer to the page 6 as to the product guaranteed maximum junction temperature 150°C

BCR3KM

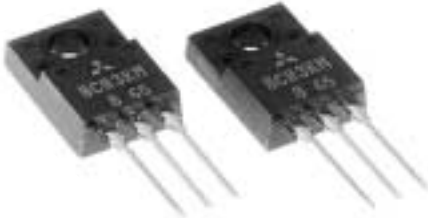

- IT (RMS) 3A
- VDRM 600V
- IFGT I, IRGT I, IRGT III 15mA (10mA) *3
- UL Recognized: Yellow Card No.E80276(N)
File No. E80271

OUTLINE DRAWING Dimensions in mm

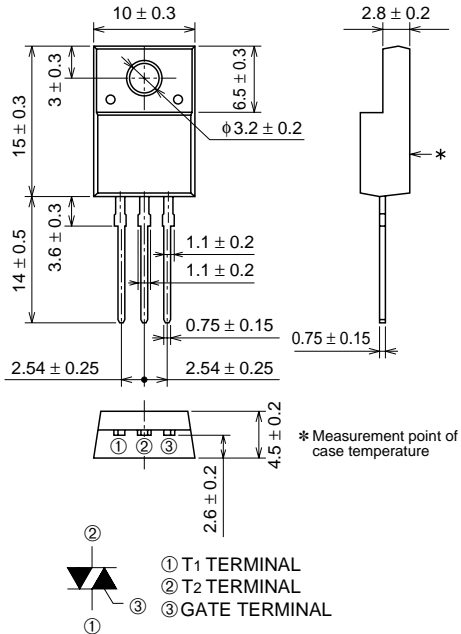

* Measurement point of case temperature

TO-220FN

APPLICATION

Control of heater such as electric rice cooker, electric pot

MAXIMUM RATINGS

Symbol	Parameter	Voltage class	
		12	Unit
VDRM	Repetitive peak off-state voltage*1	600	V
VDSM	Non-repetitive peak off-state voltage*1	720	V

Symbol	Parameter	Conditions	Ratings	Unit
IT (RMS)	RMS on-state current	Commercial frequency, sine full wave 360° conduction, Tc=111°C	3	A
ITSM	Surge on-state current	60Hz sinewave 1 full cycle, peak value, non-repetitive	30	A
I ² _t	I ² _t for fusing	Value corresponding to 1 cycle of half wave 60Hz, surge on-state current	3.7	A ² s
PGM	Peak gate power dissipation		3	W
PG (AV)	Average gate power dissipation		0.3	W
VGM	Peak gate voltage		6	V
IGM	Peak gate current		0.5	A
T _j	Junction temperature		-40 ~ +125	°C
T _{stg}	Storage temperature		-40 ~ +125	°C
—	Weight		2.0	g
V _{iso}	Isolation voltage	Ta=25°C, AC 1 minute, T1 · T2 · G terminal to case	2000	V

*1. Gate open.

BCR3KM

Refer to the page 6 as to the product guaranteed maximum junction temperature 150°C

LOW POWER USE
INSULATED TYPE, PLANAR PASSIVATION TYPE

ELECTRICAL CHARACTERISTICS

Symbol	Parameter	Test conditions	Limits			Unit
			Min.	Typ.	Max.	
IDRM	Repetitive peak off-state current	T _j =125°C, V _{DRM} applied	—	—	2.0	mA
VTM	On-state voltage	T _c =25°C, I _{TM} =4.5A, Instantaneous measurement	—	—	1.5	V
VFGT I	Gate trigger voltage *2	T _j =25°C, V _D =6V, R _L =6Ω, R _G =330Ω	I	—	1.5	V
VRGT I			II	—	1.5	V
VRGT III			III	—	1.5	V
IFGT I	Gate trigger current *2	T _j =25°C, V _D =6V, R _L =6Ω, R _G =330Ω	I	—	15*3	mA
IRGT I			II	—	15*3	mA
IRGT III			III	—	15*3	mA
VGD	Gate non-trigger voltage	T _j =125°C, V _D =1/2V _{DRM}	0.2	—	—	V
R _{th} (j-c)	Thermal resistance	Junction to case *4	—	—	4.0	°C/W
R _{th} (j-a)	Thermal resistance	Junction to ambient	—	—	50	°C/W

*2. Measurement using the gate trigger characteristics measurement circuit.

*3. High sensitivity (IGT ≤ 10mA) is also available. (IGT item ①)

*4. The contact thermal resistance R_{th} (c-f) in case of greasing is 0.5°C/W.

PERFORMANCE CURVES

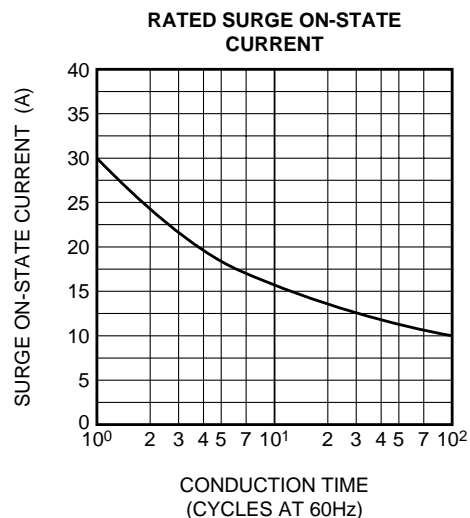
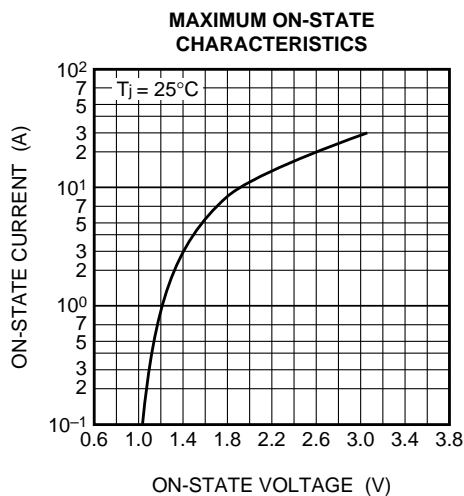

BCR3KM

Refer to the page 6 as to the product guaranteed maximum junction temperature 150°C

LOW POWER USE
INSULATED TYPE, PLANAR PASSIVATION TYPE

GATE CHARACTERISTICS (I, II AND III)

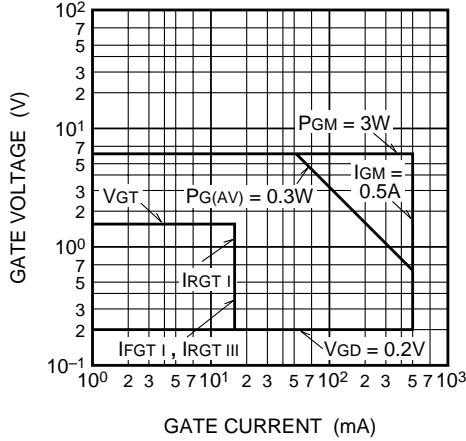

GATE TRIGGER CURRENT VS. JUNCTION TEMPERATURE

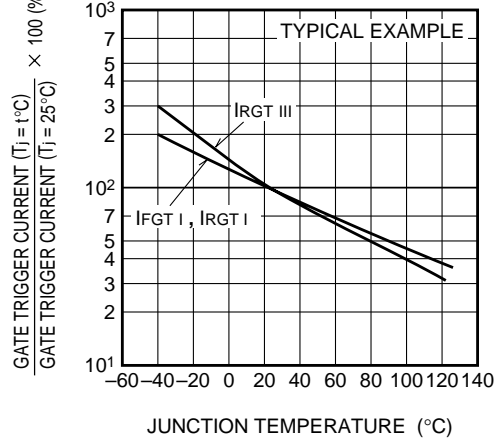

GATE TRIGGER VOLTAGE VS. JUNCTION TEMPERATURE

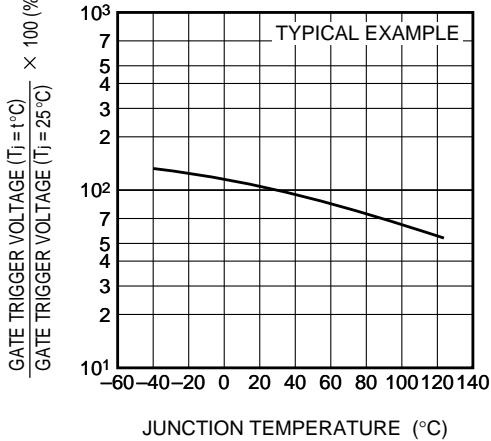

MAXIMUM TRANSIENT THERMAL IMPEDANCE CHARACTERISTICS (JUNCTION TO CASE)

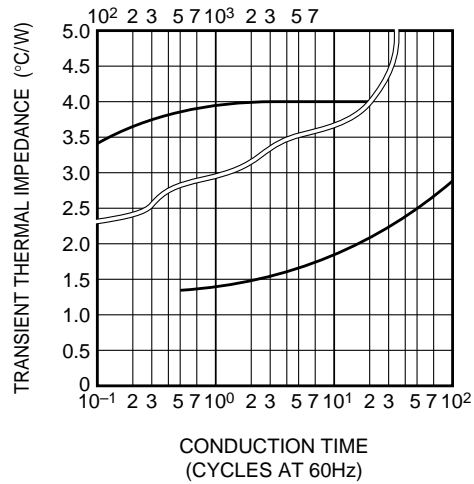

MAXIMUM TRANSIENT THERMAL IMPEDANCE CHARACTERISTICS (JUNCTION TO AMBIENT)

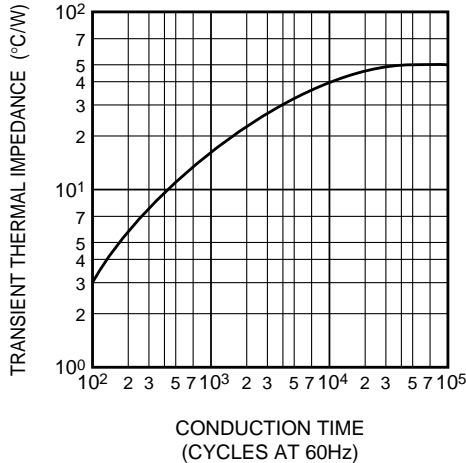

MAXIMUM ON-STATE POWER DISSIPATION

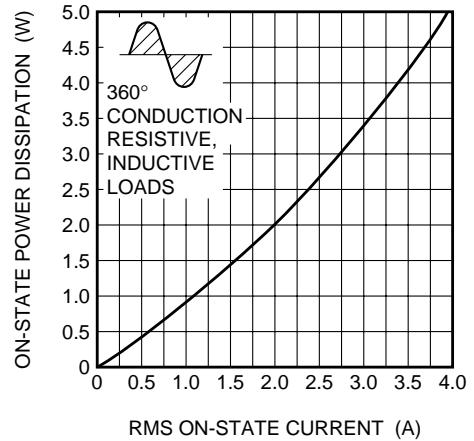

BCR3KM

Refer to the page 6 as to the product guaranteed maximum junction temperature 150°C

LOW POWER USE
INSULATED TYPE, PLANAR PASSIVATION TYPE

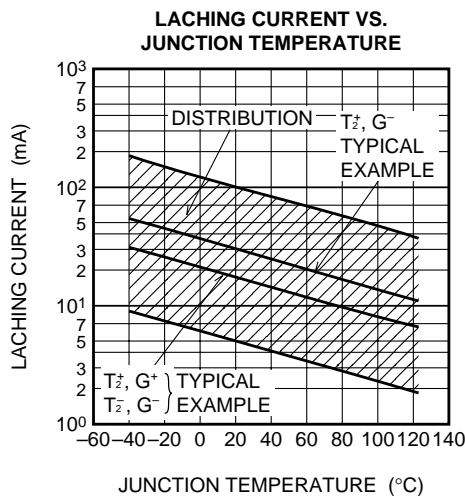
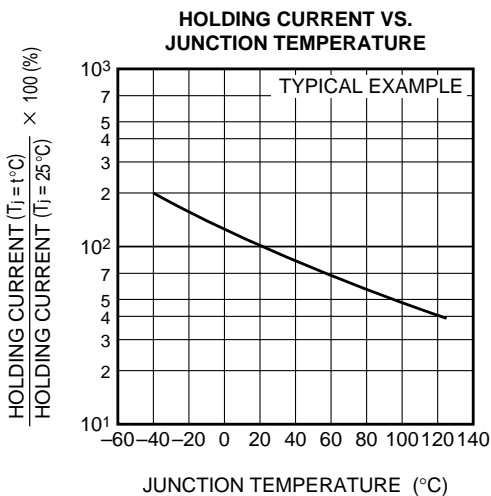
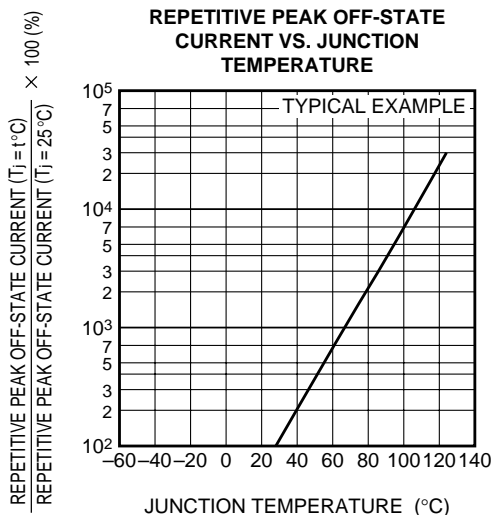
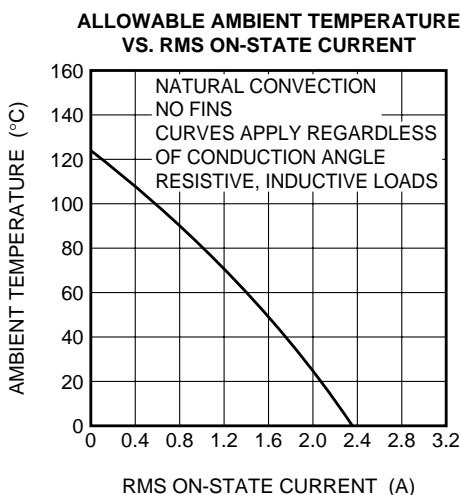
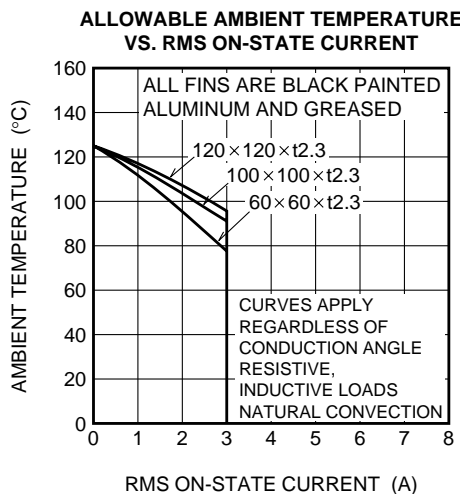
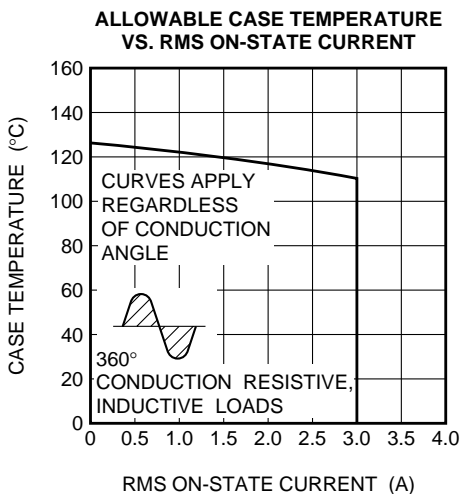

BCR3KM

Refer to the page 6 as to the product guaranteed maximum junction temperature 150°C

LOW POWER USE
INSULATED TYPE, PLANAR PASSIVATION TYPE

BREAKOVER VOLTAGE VS. JUNCTION TEMPERATURE

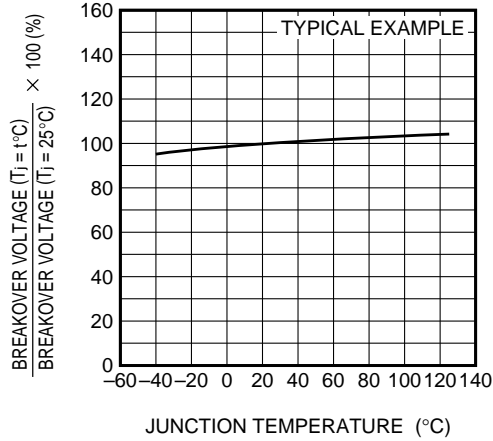

BREAKOVER VOLTAGE VS. RATE OF RISE OF OFF-STATE VOLTAGE

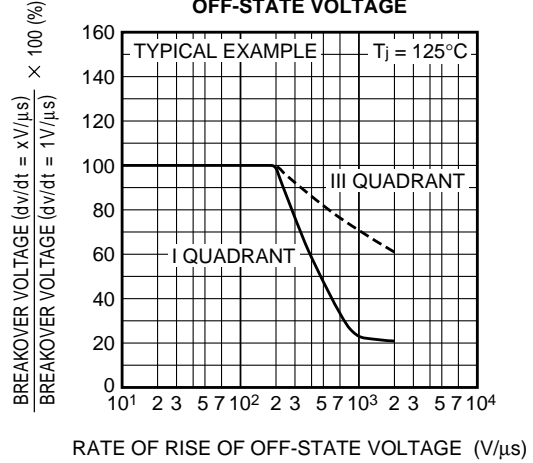

GATE TRIGGER CURRENT VS. GATE CURRENT PULSE WIDTH

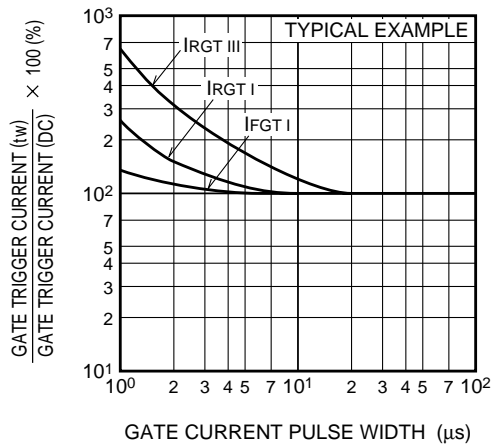

GATE TRIGGER CHARACTERISTICS TEST CIRCUITS

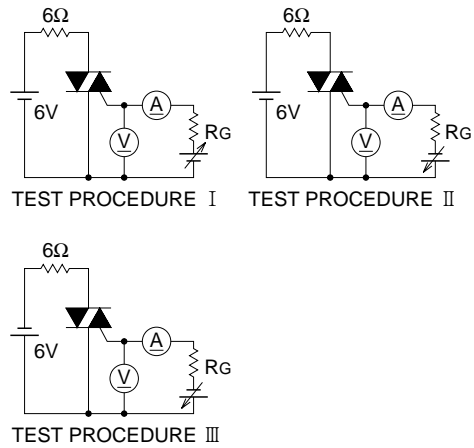

BCR3KM

LOW POWER USE

INSULATED TYPE, PLANAR PASSIVATION TYPE

The product guaranteed maximum junction temperature 150°C (See warning.)

BCR3KM

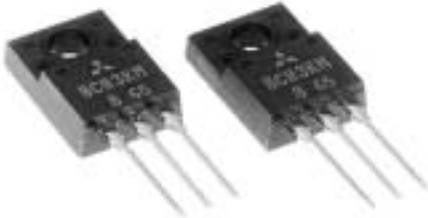

- IT (RMS) 3A
- VDRM 600V
- IFGT I , IRGT I , IRGT III 15mA (10mA) *3
- UL Recognized: Yellow Card No.E80276(N)
File No. E80271

OUTLINE DRAWING Dimensions in mm

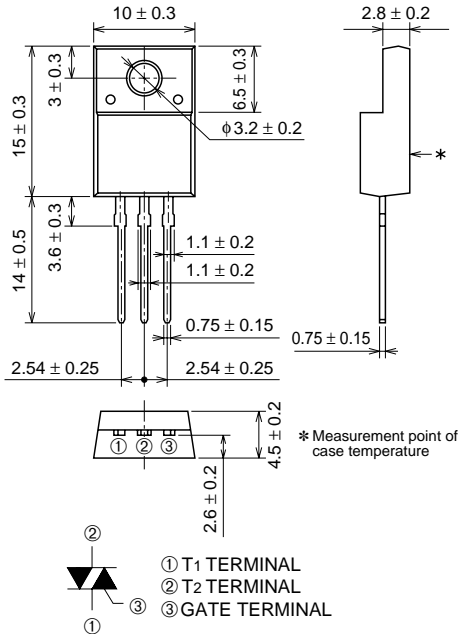

TO-220FN

APPLICATION

Control of heater such as electric rice cooker, electric pot

(Warning)

1. Refer to the recommended circuit values around the triac before using.
2. Be sure to exchange the specification before using. If not exchanged, general triacs will be supplied.

MAXIMUM RATINGS

Symbol	Parameter	Voltage class	
		12	Unit
VDRM	Repetitive peak off-state voltage*1	600	V
VDSM	Non-repetitive peak off-state voltage*1	720	V

Symbol	Parameter	Conditions	Ratings	Unit
IT (RMS)	RMS on-state current	Commercial frequency, sine full wave 360° conduction, Tc=136°C	3	A
ITSM	Surge on-state current	60Hz sinewave 1 full cycle, peak value, non-repetitive	30	A
I ² _t	I ² _t for fusing	Value corresponding to 1 cycle of half wave 60Hz, surge on-state current	3.7	A ² s
PGM	Peak gate power dissipation		3	W
P _{G(AV)}	Average gate power dissipation		0.3	W
VGM	Peak gate voltage		6	V
IGM	Peak gate current		0.5	A
T _j	Junction temperature		-40 ~ +150	°C
T _{stg}	Storage temperature		-40 ~ +150	°C
—	Weight		2.0	g
V _{iso}	Isolation voltage	Ta=25°C, AC 1 minute, T1 · T2 · G terminal to case	2000	V

*1. Gate open.

BCR3KM

The product guaranteed maximum junction temperature 150°C (See warning.)

LOW POWER USE
INSULATED TYPE, PLANAR PASSIVATION TYPE

ELECTRICAL CHARACTERISTICS

Symbol	Parameter	Test conditions	Limits			Unit	
			Min.	Typ.	Max.		
IDRM	Repetitive peak off-state current	T _j =150°C, V _{DRM} applied	—	—	2.0	mA	
V _{TM}	On-state voltage	T _c =25°C, I _{TM} =4.5A, Instantaneous measurement	—	—	1.5	V	
V _{FGT I}	Gate trigger voltage *2	T _j =25°C, V _D =6V, R _L =6Ω, R _G =330Ω	I	—	—	1.5	V
V _{RGT I}			II	—	—	1.5	V
V _{RGT III}			III	—	—	1.5	V
I _{FGT I}	Gate trigger current *2	T _j =25°C, V _D =6V, R _L =6Ω, R _G =330Ω	I	—	—	15*3	mA
I _{RGT I}			II	—	—	15*3	mA
I _{RGT III}			III	—	—	15*3	mA
V _{GD}	Gate non-trigger voltage	T _j =125°C/150°C, V _D =1/2V _{DRM}	0.2/0.1	—	—	V	
R _{th (j-c)}	Thermal resistance	Junction to case *4	—	—	4.0	°C/W	
R _{th (j-a)}	Thermal resistance	Junction to ambient	—	—	50	°C/W	

*2. Measurement using the gate trigger characteristics measurement circuit.

*3. High sensitivity (I_{GT} ≤ 10mA) is also available. (IGT item ①)

*4. The contact thermal resistance R_{th (c-f)} in case of greasing is 0.5°C/W.

PERFORMANCE CURVES

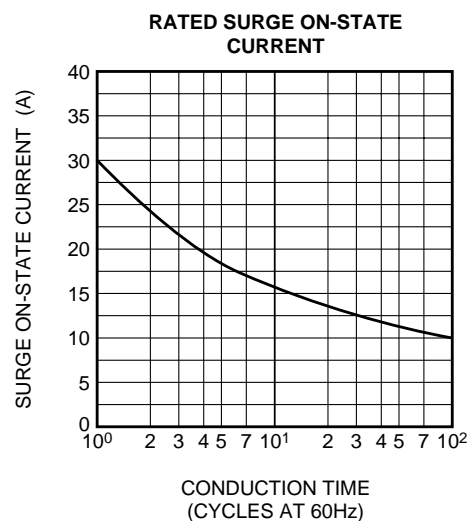
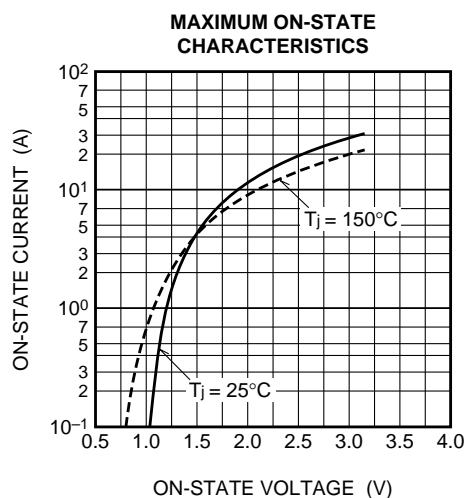

BCR3KM

The product guaranteed maximum junction temperature 150°C (See warning.)

LOW POWER USE
INSULATED TYPE, PLANAR PASSIVATION TYPE

**GATE CHARACTERISTICS
(I, II AND III)**

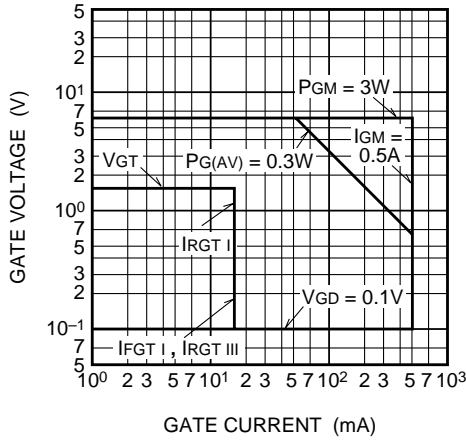

**GATE TRIGGER CURRENT VS.
JUNCTION TEMPERATURE**

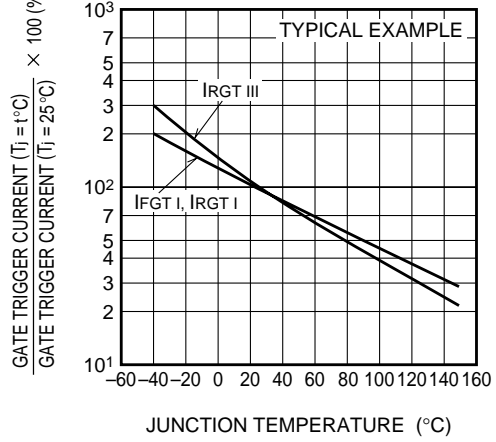

**GATE TRIGGER VOLTAGE VS.
JUNCTION TEMPERATURE**

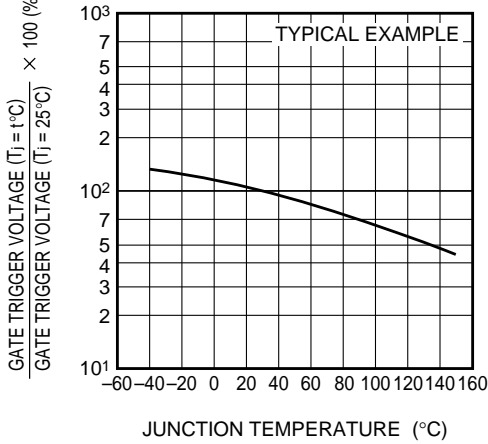

**MAXIMUM TRANSIENT THERMAL
IMPEDANCE CHARACTERISTICS
(JUNCTION TO CASE)**

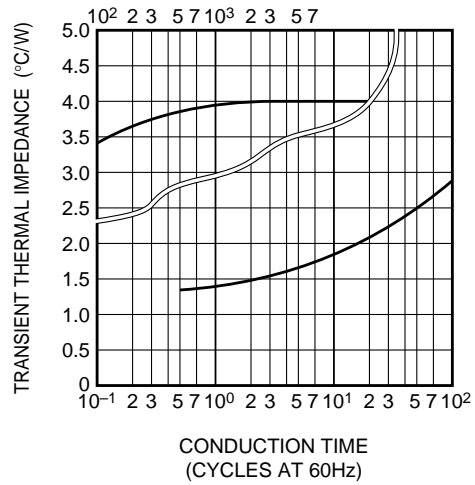

**MAXIMUM TRANSIENT THERMAL
IMPEDANCE CHARACTERISTICS
(JUNCTION TO AMBIENT)**

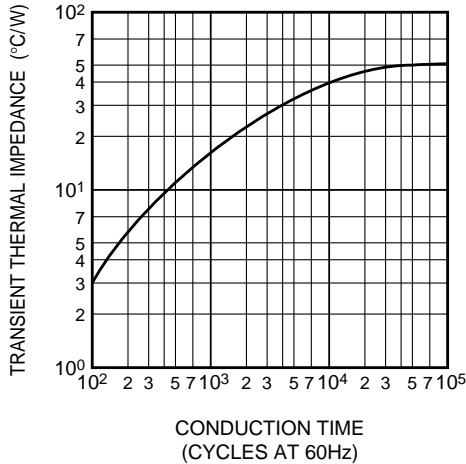

**MAXIMUM ON-STATE POWER
DISSIPATION**

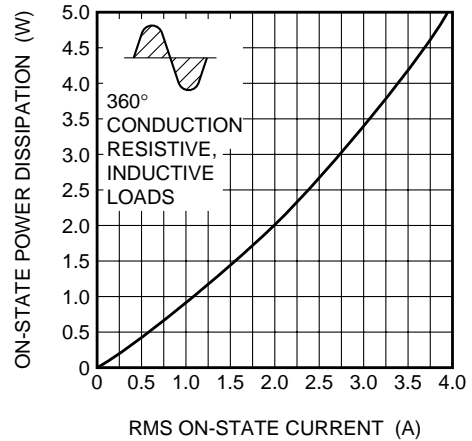

BCR3KM

The product guaranteed maximum junction temperature 150°C (See warning.)

LOW POWER USE
INSULATED TYPE, PLANAR PASSIVATION TYPE

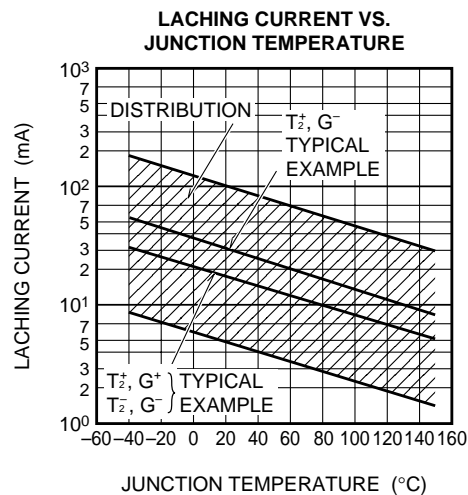
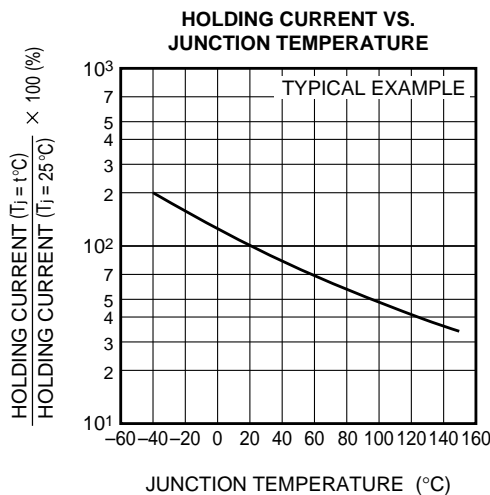
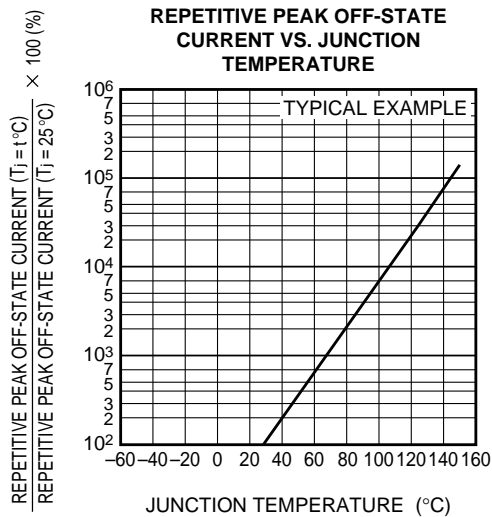
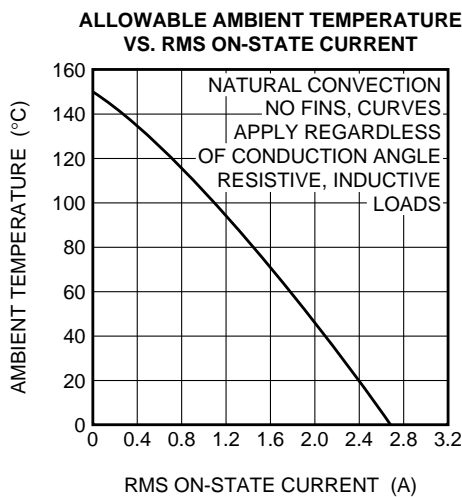
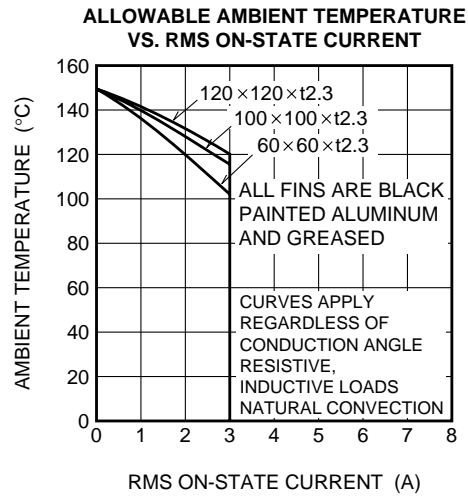
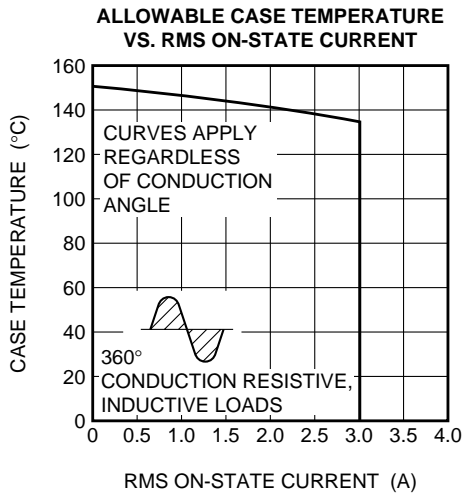

BCR3KM

The product guaranteed maximum junction temperature 150°C (See warning.)

LOW POWER USE
INSULATED TYPE, PLANAR PASSIVATION TYPE

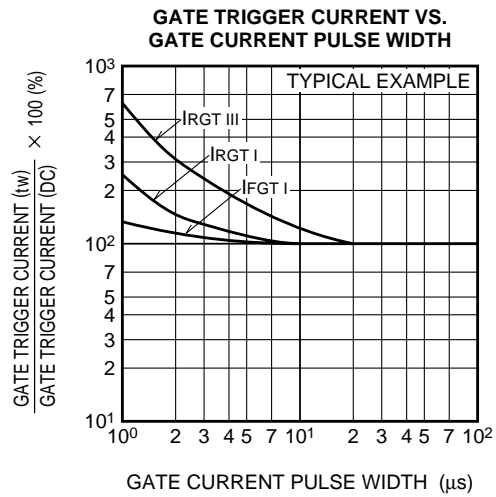
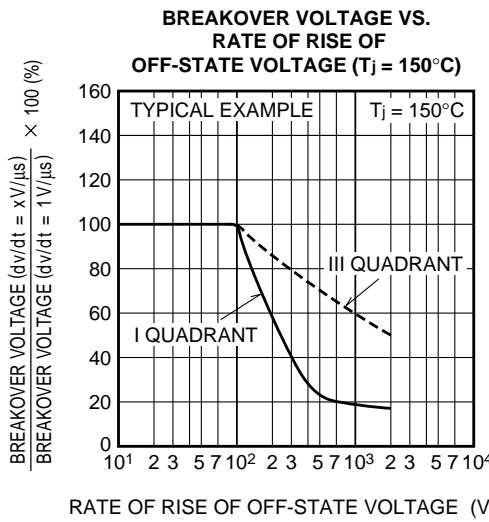
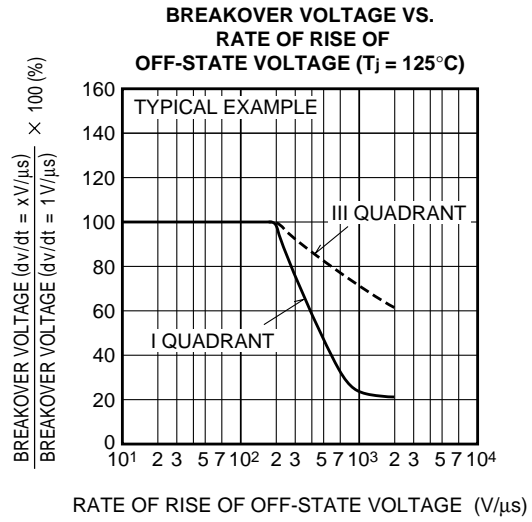
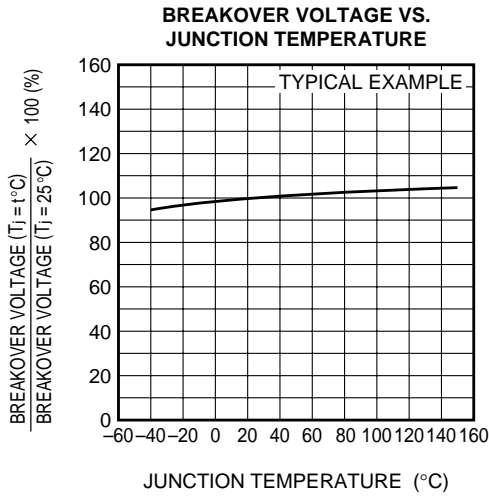

GATE TRIGGER CHARACTERISTICS TEST CIRCUITS

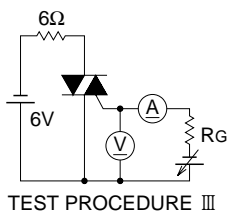
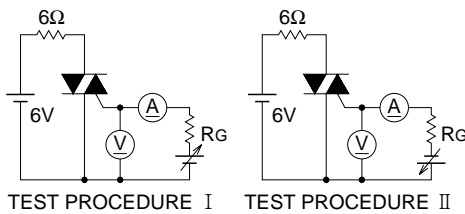

RECOMMENDED CIRCUIT VALUES AROUND THE TRIAC

