

1. PART NO. EXPRESSION :

SCI0805S-2N8KF

(a) (b) (c) (d) (e)(f)

(a) Series code

(b) Dimension code

(c) Type code : S (Standard)

(d) Inductance code : 2N8 = 2.8nH

(e) Tolerance code : G = ±2%, J = ±5%, K = ±10%

(f) F : RoHS Compliant

2. CONFIGURATION & DIMENSIONS :

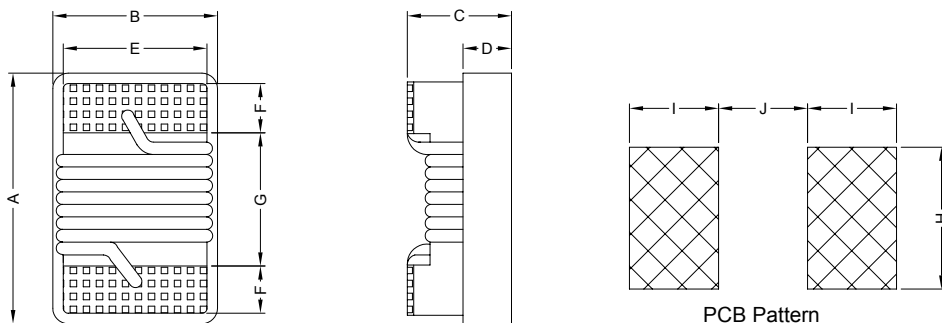

PCB Pattern

Unit:m/m

A	B	C	D	E	F	G	H	I	J
2.29 Max.	1.73 Max.	1.52 Max.	0.51 Ref.	1.27 Ref.	0.51 Ref.	1.02 Ref.	1.78 Ref.	1.02 Ref.	0.76 Ref.

3. SCHEMATIC :

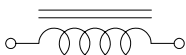

4. MATERIALS :

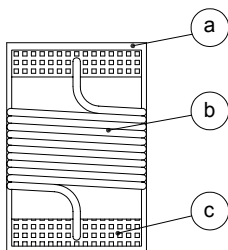

(a) Core : Ceramic U core

(b) Wire : Enamelled Copper Wire

(c) Terminal Metallization : Ag + Ni + Au



RoHS Compliant

NOTE : Specifications subject to change without notice. Please check our website for latest information.

22.06.2010



SUPERWORLD ELECTRONICS (S) PTE LTD

5. GENERAL SPECIFICATION :

- a) Storage temp. : -25°C to +80°C
- b) Operating temp. : -40°C to +125°C
- c) Temperature rise : 40°C Max.
- d) Rated current : Base on temp. rise & $\Delta L/L0A=10\%$ Max.
- e) Resistance to solder heat : 260°C.10sec

6. ELECTRICAL CHARACTERISTICS :

Part No.	Tolerance Available	L (nH)	Test Freq (MHz)	Q Min.	Q Test Freq (MHz)	SRF (MHz) Min.	DCR (Ω) Max.	IDC (mA) Max.
SCI0805S-2N8□F	K, J	2.8	250	80	1500	7900	0.060	800
SCI0805S-3N0□F	K, J	3.0	250	65	1500	7900	0.060	800
SCI0805S-3N3□F	K, J	3.3	250	50	1500	6000	0.080	600
SCI0805S-5N6□F	K, J	5.6	250	65	1000	5500	0.080	600
SCI0805S-6N8□F	K, J	6.8	250	50	1000	5500	0.110	600
SCI0805S-7N5□F	K, J	7.5	250	50	1000	4500	0.140	600
SCI0805S-8N2□F	K, J	8.2	250	50	1000	4700	0.120	600
SCI0805S-8N7□F	K, J	8.7	250	50	1000	3900	0.210	400
SCI0805S-10N□F	K, J, G	10	250	60	500	4200	0.100	600
SCI0805S-12N□F	K, J, G	12	250	50	500	4000	0.150	600
SCI0805S-15N□F	K, J, G	15	250	50	500	3400	0.170	600
SCI0805S-18N□F	K, J, G	18	250	50	500	3300	0.200	600
SCI0805S-22N□F	K, J, G	22	250	55	500	2600	0.220	500
SCI0805S-24N□F	K, J, G	24	250	50	500	2000	0.220	500
SCI0805S-27N□F	K, J, G	27	250	55	500	2500	0.250	500
SCI0805S-33N□F	K, J, G	33	250	60	500	2050	0.270	500
SCI0805S-36N□F	K, J, G	36	250	55	500	1700	0.270	500
SCI0805S-39N□F	K, J, G	39	250	60	500	2000	0.290	500
SCI0805S-43N□F	K, J, G	43	200	60	500	1650	0.340	500
SCI0805S-47N□F	K, J, G	47	200	60	500	1650	0.310	500
SCI0805S-56N□F	K, J, G	56	200	60	500	1550	0.340	500
SCI0805S-68N□F	K, J, G	68	200	60	500	1450	0.380	500
SCI0805S-72N□F	K, J, G	72	150	65	500	1400	0.400	500
SCI0805S-82N□F	K, J, G	82	150	65	500	1300	0.420	400
SCI0805S-91N□F	K, J, G	91	150	65	500	1200	0.480	400



RoHS Compliant

NOTE : Specifications subject to change without notice. Please check our website for latest information.

22.06.2010



SUPERWORLD ELECTRONICS (S) PTE LTD

6. ELECTRICAL CHARACTERISTICS :

Part No.	Tolerance Available	L (nH)	Test Freq (MHz)	Q Min.	Q Test Freq (MHz)	SRF (MHz) Min.	DCR (Ω) Max.	IDC (mA) Max.
SCI0805S-R10□F	K, J, G	100	150	65	500	1200	0.460	400
SCI0805S-R11□F	K, J, G	110	150	50	250	1000	0.480	400
SCI0805S-R12□F	K, J, G	120	150	50	250	1100	0.510	400
SCI0805S-R15□F	K, J, G	150	100	50	250	920	0.560	400
SCI0805S-R18□F	K, J, G	180	100	50	250	870	0.640	400
SCI0805S-R20□F	K, J, G	200	100	50	250	860	0.660	400
SCI0805S-R22□F	K, J, G	220	100	50	250	850	0.700	400
SCI0805S-R24□F	K, J, G	240	100	44	250	690	1.00	350
SCI0805S-R25□F	K, J, G	250	100	45	250	680	1.00	350
SCI0805S-R27□F	K, J, G	270	100	48	250	650	1.00	350
SCI0805S-R30□F	K, J, G	300	100	48	250	620	1.20	330
SCI0805S-R33□F	K, J, G	330	100	48	250	600	1.40	310
SCI0805S-R36□F	K, J, G	360	100	48	250	580	1.45	300
SCI0805S-R39□F	K, J, G	390	100	48	250	560	1.50	290
SCI0805S-R43□F	K, J, G	430	50	33	100	430	1.70	230
SCI0805S-R47□F	K, J, G	470	50	33	100	375	1.70	220
SCI0805S-R56□F	K, J, G	560	25	23	50	340	1.90	210
SCI0805S-R62□F	K, J, G	620	25	23	50	220	2.20	210
SCI0805S-R68□F	K, J, G	680	25	23	50	200	2.20	190
SCI0805S-R75□F	K, J, G	750	25	23	50	200	2.30	180
SCI0805S-R82□F	K, J, G	820	25	23	50	200	2.35	180
SCI0805S-1R0□F	K, J, G	1000	25	20	50	100	2.50	170
SCI0805S-1R2□F	K, J, G	1200	7.96	18	25	100	2.50	170
SCI0805S-1R5□F	K, J, G	1500	7.96	16	25	100	2.50	170
SCI0805S-1R8□F	K, J, G	1800	7.96	16	7.96	80	2.50	170
SCI0805S-2R2□F	K, J, G	2200	7.96	16	7.96	60	2.70	160
SCI0805S-2R7□F	K, J, G	2700	7.96	16	7.96	50	2.95	150

Inductance tolerance :

- : G : $\pm 2\%$
- J : $\pm 5\%$
- K : $\pm 10\%$



RoHS Compliant

NOTE : Specifications subject to change without notice. Please check our website for latest information.

22.06.2010



SUPERWORLD ELECTRONICS (S) PTE LTD

7. PACKAGING INFORMATION :

Reel Configuration :

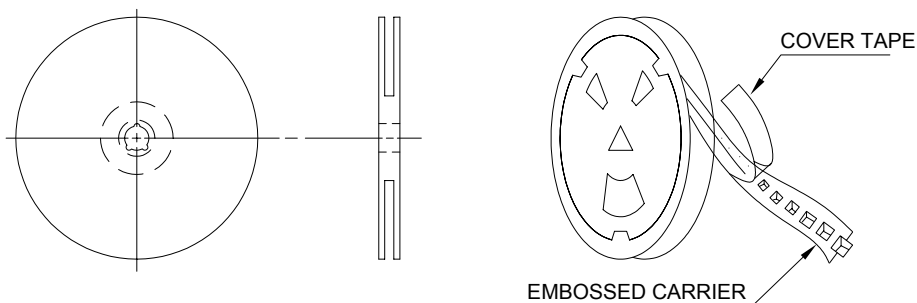

Paper Tape :

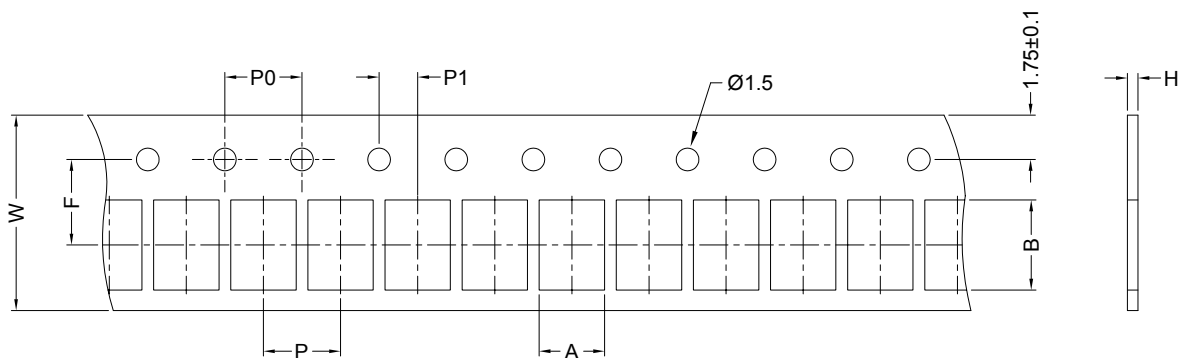

Dimension (unit: mm)

Series	A	B	H	F	P	P0	P1	W	Qty
SCI0402S	0.72	1.19	0.60	3.50	4.00	4.00	2.00	8.00	4000pcs / reel
SCI0603S	1.35	1.95	0.95	3.50	4.00	4.00	2.00	8.00	4000pcs / reel



RoHS Compliant

NOTE : Specifications subject to change without notice. Please check our website for latest information.

22.06.2010



SUPERWORLD ELECTRONICS (S) PTE LTD

Embossed Carrier Tape :

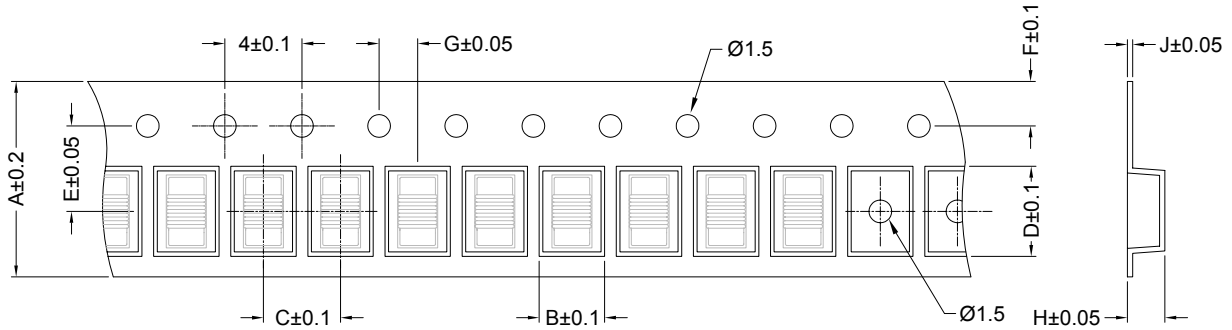

Dimension (unit: mm)

Series	A	B	C	D	E	F	G	H	J	Qty
SCI0805S	8	1.85	4	2.30	3.5	1.75	2	1.45	0.23	2000pcs / reel
SCI0805LP	8	1.80	4	2.30	3.5	1.75	2	0.90	0.23	2000pcs / reel
SCI0805HQ	8	1.85	4	2.30	3.5	1.75	2	1.45	0.23	2000pcs / reel
SCI1008S	8	2.70	4	2.80	3.5	1.75	2	2.00	0.23	2000pcs / reel
SCI1008LP	8	2.70	4	2.80	3.5	1.75	2	1.50	0.23	2000pcs / reel
SCI1008HQ	8	2.70	4	2.80	3.5	1.75	2	2.00	0.23	2000pcs / reel

Leader/Trailer Tape :

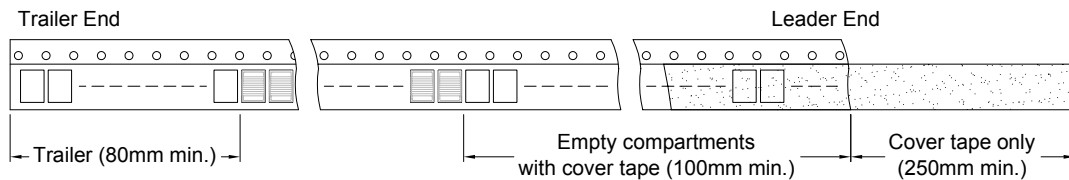

Peel-off Force :

Peel-off force should be in the range of 0.1N~0.7N at a peel-off speed of 300±10mm/min.

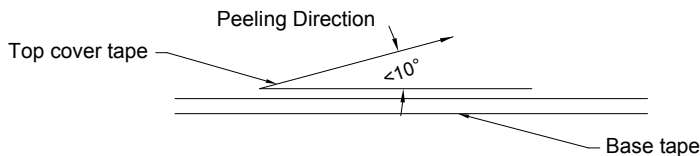

RoHS Compliant

NOTE : Specifications subject to change without notice. Please check our website for latest information.

22.06.2010



SUPERWORLD ELECTRONICS (S) PTE LTD

8. ENVIRONMENTAL CHARACTERISTICS :

Electrical Performance Test :

ITEM		SPECIFICATION	TEST CONDITIONS / TEST METHODS
1	Inductance	Refer to Electrical Characteristics List	HP4291B
2	Q		HP4291B
3	SRF		HP8753D
4	DC Resistance Rdc		Mico-Ohmmeter (GOM-801G)
5	Rated Current IDC		The device should be REFLOW soldered (230±5°C for 10 seconds) to a tinned copper subs rate. A dynamiter
6	Over Load Test	After test, inductors shall have no evidence of electrical and mechanical damage	Applied 2 times of rated allowed DC current to inductor for a period of 5 minute.
7	Withstanding Voltage Test	After test, inductors shall have no evidence of electrical and mechanical damage	AC voltage of 500VAC applied between inductors terminal and case for 1 minute.
8	Insulation Resistance Test	1000 MOhm min.	100VDC applied between inductor terminal and case



RoHS Compliant

NOTE : Specifications subject to change without notice. Please check our website for latest information.

22.06.2010



SUPERWORLD ELECTRONICS (S) PTE LTD

Mechanical Performance Test :

ITEM		SPECIFICATION	TEST CONDITIONS / TEST METHODS
1	Vibration	Appearance : No damage L change : within $\pm 5\%$ Q change : within $\pm 10\%$	Test device shall be soldered on the substrate Oscillation Frequency : 10 to 55 to 10Hz for 1 min. Amplitude : 1.5mm Time : 2hrs for each axis (X, Y, Z), total 6hrs.
2	Resistance to Soldering Heat	Appearance : No damage L change : within $\pm 5\%$ Q change : within $\pm 10\%$	Pre-heating : 150°C, 1 min Solder Composition : Sn/Pb=63/67 Solder Temperature : 230 \pm 5°C Immersion Time : 20 \pm 2sec Solder Temperature : 260 \pm 5°C Immersion Time : 5 \pm 2sec
3	Component Adhesion (Push Test)	1 lbs. For 0402 2 lbs. For 0603 3 lbs. For the rest	The device should be REFLOW soldered (230 \pm 5°C for 10 seconds) to a tinned copper subs rate. A dynamiter force gauge should be applied to the side of the component. The device must withstand a minimum force of 2 or 4 pounds without a failure of the termination attached to component.
3	Component Adhesion (Push Test)	The electrodes shall be at least 90% covered with new solder coating.	Pre-heating : 150°C, 1min Solder Composition : Sn/Pb=63/67 Solder Temperature : 230 \pm 5°C Immersion Time : 4 \pm 1sec
4	Drop Test	After test, the chip inductor don't fell of broke on the P.C.Board	Drop 1 time for each face and 1 time for each corner. Total drop 10 times. Drop Height : 100cm Drop Weight : 125g
5	Solderability Test	The terminal should at least be 90% covered with solder	after fluxing (alpha 100 or equiv), inductor shall be dipped in a melted solder bath at 232 \pm 5°C for 5 seconds.
6	Resistance to solvent test	There shall be no case of deformation change in appearance of obliteration of marking	MIL-STD202F, METHOD 215D



RoHS Compliant

NOTE : Specifications subject to change without notice. Please check our website for latest information.

22.06.2010



SUPERWORLD ELECTRONICS (S) PTE LTD

PG. 7

Climatic Test :

ITEM		SPECIFICATION	TEST CONDITIONS / TEST METHODS															
1	Temperature Characteristics	Appearance : No damage L change : within $\pm 10\%$ Q change : within $\pm 20\%$	-40°C ~ +125°C															
2	Humidity Resistance		Temperature : 40 \pm 2°C Relative Humidity : 90~95% Time : 96hrs \pm 2hrs Measured after exposure in the room condition for 2hrs															
3	Low Temperature Storage Test		Temperature : -40 \pm 2°C Time : 48 \pm 2hrs Inductors are to be tested after 1 hour at room temperature.															
4	Thermal Shock Test		One cycle : <table border="1" style="margin-left: 20px;"> <thead> <tr> <th>Step</th> <th>Temperature (°C)</th> <th>Time (min)</th> </tr> </thead> <tbody> <tr> <td>1</td> <td>-25\pm3</td> <td>30</td> </tr> <tr> <td>2</td> <td>25\pm2</td> <td>15</td> </tr> <tr> <td>3</td> <td>85\pm3</td> <td>30</td> </tr> <tr> <td>4</td> <td>25\pm2</td> <td>15</td> </tr> </tbody> </table> Total : 5 cycles	Step	Temperature (°C)	Time (min)	1	-25 \pm 3	30	2	25 \pm 2	15	3	85 \pm 3	30	4	25 \pm 2	15
Step	Temperature (°C)		Time (min)															
1	-25 \pm 3		30															
2	25 \pm 2		15															
3	85 \pm 3	30																
4	25 \pm 2	15																
5	High Temperature Storage Test	Temperature : 125 \pm 2°C Time : 48 \pm 2hrs Load : Allowed DC current																
6	High Temperature Load Life Test	Temperature : 85 \pm 2°C Time : 1000 \pm 12hrs Load : Allowed DC current																
7	Humidity Load Life	Temperature : 40 \pm 2°C Relative Humidity : 90~95% Time : 1000 \pm 12hrs Load : Allowed DC current																



RoHS Compliant

NOTE : Specifications subject to change without notice. Please check our website for latest information.

22.06.2010



SUPERWORLD ELECTRONICS (S) PTE LTD