

**PLEASE CHECK WWW.MOLEX.COM FOR LATEST PART INFORMATION**

**Part Number:** [0781191258](#)  
**Status:** **Active**  
**Overview:** ffc fpc smt  
**Description:** 0.50mm (.020") Pitch FFC/FPC Connector, SMT, Non ZIF, Vertical, Gold Plating, 25 Circuits, Lead Free

**Documents:**

[3D Model](#) [Product Specification PS-78119-001 \(PDF\)](#)  
[Drawing \(PDF\)](#) [RoHS Certificate of Compliance \(PDF\)](#)

**Agency Certification**

CSA LR19980  
 UL E29179

**General**

Product Family FFC/FPC Connectors  
 Series [78119](#)  
 Overview [ffc fpc smt](#)  
 Product Name N/A

**Physical**

Circuits (Loaded) 25  
 Color - Resin Natural  
 Contact Position N/A  
 Durability (mating cycles max) 20  
 Entry Angle Vertical  
 Flammability 94V-0  
 Mated Height (in) 0.161 In  
 Mated Height (mm) 4.10 mm  
 Material - Metal Copper Alloy  
 Material - Plating Mating Gold, Nickel  
 Number of Rows 1  
 Orientation Vertical  
 PCB Locator No  
 PCB Retention None  
 Packaging Type Embossed Tape on Reel  
 Pitch - Mating Interface (in) 0.020 In  
 Pitch - Mating Interface (mm) 0.50 mm  
 Pitch - Term. Interface (in) 0.020 In  
 Pitch - Term. Interface (mm) 0.50 mm  
 Polarized to PCB No  
 Stackable No  
 Temperature Range - Operating -40°C to +85°C  
 Termination Interface: Style Surface Mount  
 Wire/Cable Type FFC/FPC

**Electrical**

Current - Maximum per Contact 0.5A  
 Voltage - Maximum 50V AC

**Material Info**

**Reference - Drawing Numbers**

Package Specification SPK-78119-001  
 Product Specification PS-78119-001  
 Sales Drawing SD-78119-001

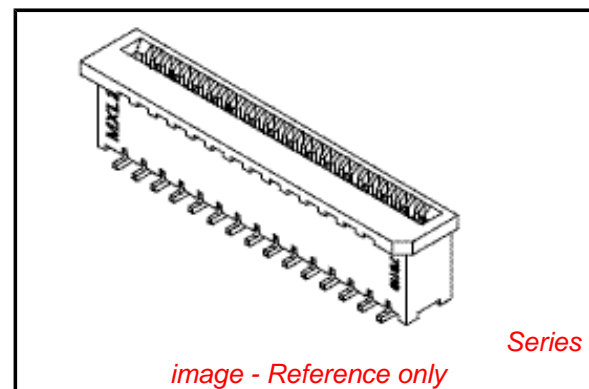

*image - Reference only*

**EU RoHS**

**ELV and RoHS  
 Compliant**  
**REACH SVHC  
 Contains SVHC: No**  
**Halogen-Free  
 Status  
 Not Reviewed**

**China RoHS**



**Need more information on product  
 environmental compliance?**

Email [productcompliance@molex.com](mailto:productcompliance@molex.com)  
 For a multiple part number RoHS Certificate of  
 Compliance, [click here](#)

Please visit the [Contact Us](#) section for any  
 non-product compliance questions.

**Search Parts in this Series**

[78119Series](#)

**Mates With**

[Standard FFC/FPC Cables](#)

This document was generated on 06/07/2010

**PLEASE CHECK [WWW.MOLEX.COM](http://WWW.MOLEX.COM) FOR LATEST PART INFORMATION**

10 9 8 7 6 5 4 3 2 1

F

E

D

C

B

A

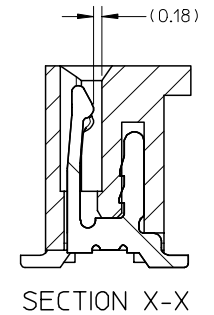
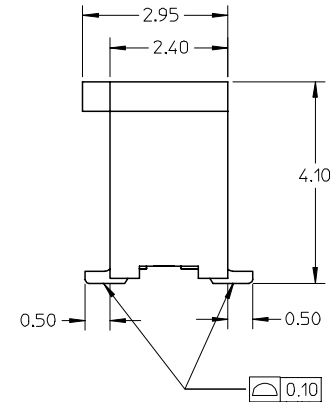
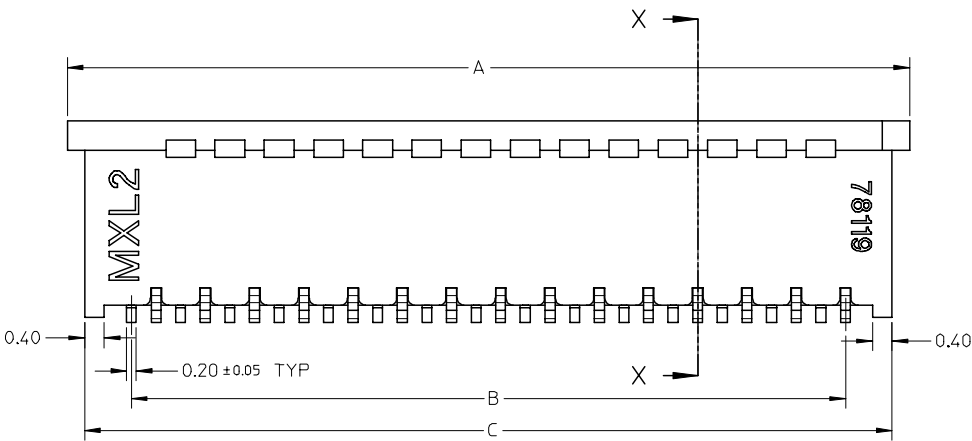
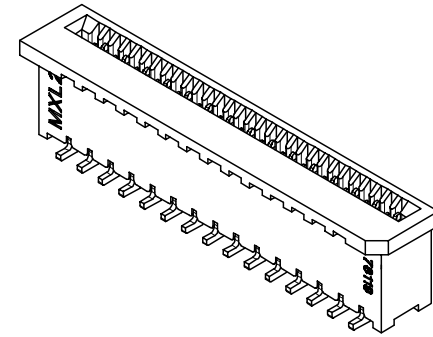
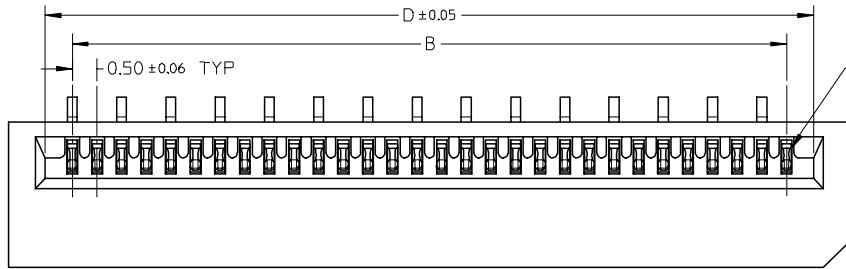

NOTE:

1. MATERIAL:  
HOUSING: PA46 GLASS FILLED, UL94V-0, COLOR: NATURAL  
TERMINAL: COPPER ALLOY
2. PLATING: 1) 0.10 μm MIN. GOLD PLATING OVER NICKEL PLATING OVERALL  
2) 1-3 μm TIN-BISMUTH OVER NICKEL PLATING OVERALL
3. PRODUCT SPECIFICATION: PS-78119-001
4. PRODUCT ARE PACKED IN TAPE & REEL.

REVISED	DESCRIPTION
EC NO: S2007-0721	2007/03/05
DRWN: BOKOK	2007/03/05
CHKD: CGOH	2007/03/05
APPR: KCLING	2007/03/05
A2	REV

QUALITY SYMBOLS	▽=0
	∇=0

GENERAL TOLERANCES (UNLESS SPECIFIED)	
	mm
	INCH
4 PLACES	± ---
3 PLACES	± ---
2 PLACES	± 0.15
1 PLACE	± ---
ANGULAR ± 3°	
DRAFT WHERE APPLICABLE MUST REMAIN WITHIN DIMENSIONS	

DIMENSION STYLE	
MM ONLY	
DRAWN BY	DATE
YLQ1A0	2006/04/11
CHECKED BY	DATE
BOKOK	2006/04/18
APPROVED BY	DATE
PTL IM	2006/04/18
MATERIAL NO.	
SEE TABLE	
SIZE	A3

SCALE	DESIGN UNITS	THIRD ANGLE PROJECTION
NTS	METRIC	
TITLE		
0.50MM PITCH, FPC CONN. NON-ZIF, SMT		
MOLEX INCORPORATED		
DOCUMENT NO.	SHEET NO.	
SD-78119-001	1 OF 7	

9 8 7 6 5 4 3 2 1

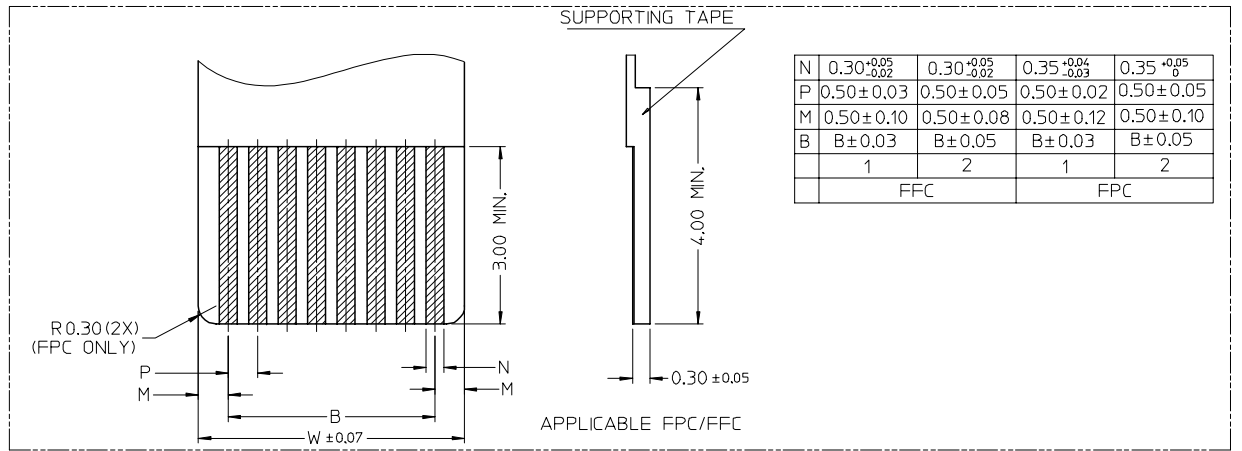
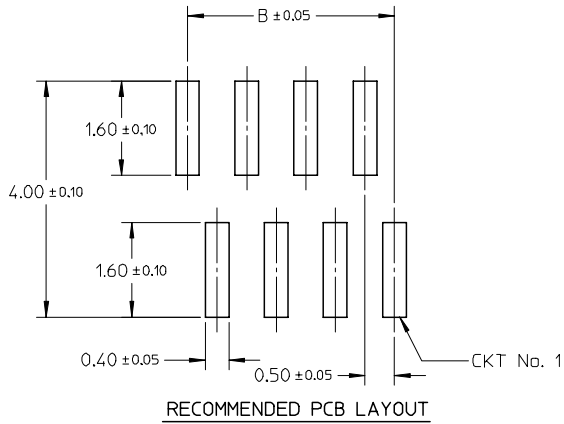

N	0.30 <sup>+0.05</sup> <sub>-0.02</sub>	0.30 <sup>+0.05</sup> <sub>-0.02</sub>	0.35 <sup>+0.04</sup> <sub>-0.03</sub>	0.35 <sup>+0.05</sup> <sub>0</sub>
P	0.50 ± 0.03	0.50 ± 0.05	0.50 ± 0.02	0.50 ± 0.05
M	0.50 ± 0.10	0.50 ± 0.08	0.50 ± 0.12	0.50 ± 0.10
B	B ± 0.03	B ± 0.05	B ± 0.03	B ± 0.05
	1	2	1	2
	FFC		FPC	

REVISED EC NO: S2007-0721 DRWN: BOKOK CHKD: CGOH APPR: KCLING	2007/03/05 2007/03/05 2007/03/05	QUALITY SYMBOLS ▽=0 ◻=0	GENERAL TOLERANCES (UNLESS SPECIFIED)		DIMENSION STYLE MM ONLY		SCALE NTS	DESIGN UNITS METRIC	THIRD ANGLE PROJECTION		
	4 PLACES ± --- ± --- 3 PLACES ± --- ± --- 2 PLACES ± 0.15 ± --- 1 PLACE ± --- ± ---	mm INCH	DRAWN BY YLQ1A0 DATE 2006/04/11	TITLE 0.50MM PITCH, FPC CONN. NON-ZIF, SMT		APPROVED BY BOKOK DATE 2006/04/18		MOLEX INCORPORATED		SHEET NO. 2 OF 7	
	ANGULAR ± 3 °		MATERIAL NO. SEE TABLE		DOCUMENT NO. SD-78119-001		SIZE A3		THIS DRAWING CONTAINS INFORMATION THAT IS PROPRIETARY TO MOLEX INCORPORATED AND SHOULD NOT BE USED WITHOUT WRITTEN PERMISSION		
	DRAFT WHERE APPLICABLE MUST REMAIN WITHIN DIMENSIONS										
	REV A2		DESCRIPTION								

GOLD PLATING TERMINAL ASSEMBLY PART NUMBERS

ASSY P/N W/O PACKAGING	CKT	DIM A	DIM B	DIM C	DIM D	PLATING TYPE
78119-0068	6	5.10	2.50	4.40	3.60	1
78119-0078	7	5.60	3.00	4.90	4.10	
78119-0088	8	6.10	3.50	5.40	4.60	
78119-0098	9	6.60	4.00	5.90	5.10	
78119-0108	10	7.10	4.50	6.40	5.60	
78119-0118	11	7.60	5.00	6.90	6.10	
78119-0128	12	8.10	5.50	7.40	6.60	
78119-0138	13	8.60	6.00	7.90	7.10	
78119-0148	14	9.10	6.50	8.40	7.60	
78119-0158	15	9.60	7.00	8.90	8.10	
78119-0168	16	10.10	7.50	9.40	8.60	
78119-0178	17	10.60	8.00	9.90	9.10	
78119-0188	18	11.10	8.50	10.40	9.60	
78119-0198	19	11.60	9.00	10.90	10.10	
78119-0208	20	12.10	9.50	11.40	10.60	
78119-0218	21	12.60	10.00	11.90	11.10	
78119-0228	22	13.10	10.50	12.40	11.60	
78119-0238	23	13.60	11.00	12.90	12.10	
78119-0248	24	14.10	11.50	13.40	12.60	
78119-0258	25	14.60	12.00	13.90	13.10	
78119-0268	26	15.10	12.50	14.40	13.60	
78119-0278	27	15.60	13.00	14.90	14.10	
78119-0288	28	16.10	13.50	15.40	14.60	
78119-0298	29	16.60	14.00	15.90	15.10	
78119-0308	30	17.10	14.50	16.40	15.60	

ASSY P/N W/O PACKAGING	CKT	DIM A	DIM B	DIM C	DIM D	PLATING TYPE
78119-0318	31	17.60	15.00	16.90	16.10	1
78119-0328	32	18.10	15.50	17.40	16.60	
78119-0338	33	18.60	16.00	17.90	17.10	
78119-0348	34	19.10	16.50	18.40	17.60	
78119-0358	35	19.60	17.00	18.90	18.10	
78119-0368	36	20.10	17.50	19.40	18.60	
78119-0378	37	20.60	18.00	19.90	19.10	
78119-0388	38	21.10	18.50	20.40	19.60	
78119-0398	39	21.60	19.00	20.90	20.10	
78119-0408	40	22.10	19.50	21.40	20.60	
78119-0418	41	22.60	20.00	21.90	21.10	
78119-0428	42	23.10	20.50	22.40	21.60	

REVISED EC NO: S2007-0721 DRWN: BOKOK CHKD: CGOH APPR: KCLING 2007/03/05 2007/03/05 2007/03/05	QUALITY SYMBOLS ▽=0 ▽=0	GENERAL TOLERANCES (UNLESS SPECIFIED)		DIMENSION STYLE MM ONLY		SCALE NTS	DESIGN UNITS METRIC	THIRD ANGLE PROJECTION	
		4 PLACES ± --- ± ---	4 PLACES ± --- ± ---	DRAWN BY YLQ1A0	DATE 2006/04/11	TITLE 0.50MM PITCH, FPC CONN. NON-ZIF, SMT			
		3 PLACES ± --- ± ---	3 PLACES ± --- ± ---	CHECKED BY BOKOK	DATE 2006/04/18				
		2 PLACES ± 0.15 ± ---	2 PLACES ± --- ± ---	APPROVED BY PTL IM	DATE 2006/04/18	MOLEX INCORPORATED			
1 PLACE ± --- ± ---	1 PLACE ± --- ± ---	MATERIAL NO. SEE TABLE		DOCUMENT NO. SD-78119-001	SHEET NO. 3 OF 7				
A2	REV	DRAFT WHERE APPLICABLE MUST REMAIN WITHIN DIMENSIONS		SIZE A3	THIS DRAWING CONTAINS INFORMATION THAT IS PROPRIETARY TO MOLEX INCORPORATED AND SHOULD NOT BE USED WITHOUT WRITTEN PERMISSION				

10 9 8 7 6 5 4 3 2 1

F

F

TIN-BISMUTH PLATING TERMINAL ASSEMBLY PART NUMBERS

ASSY P/N W/O PACKAGING	CKT	DIM A	DIM B	DIM C	DIM D	PLATING TYPE
78119-0069	6	5.10	2.50	4.40	3.60	2
78119-0079	7	5.60	3.00	4.90	4.10	
78119-0089	8	6.10	3.50	5.40	4.60	
78119-0099	9	6.60	4.00	5.90	5.10	
78119-0109	10	7.10	4.50	6.40	5.60	
78119-0119	11	7.60	5.00	6.90	6.10	
78119-0129	12	8.10	5.50	7.40	6.60	
78119-0139	13	8.60	6.00	7.90	7.10	
78119-0149	14	9.10	6.50	8.40	7.60	
78119-0159	15	9.60	7.00	8.90	8.10	
78119-0169	16	10.10	7.50	9.40	8.60	
78119-0179	17	10.60	8.00	9.90	9.10	
78119-0189	18	11.10	8.50	10.40	9.60	
78119-0199	19	11.60	9.00	10.90	10.10	
78119-0209	20	12.10	9.50	11.40	10.60	
78119-0219	21	12.60	10.00	11.90	11.10	
78119-0229	22	13.10	10.50	12.40	11.60	
78119-0239	23	13.60	11.00	12.90	12.10	
78119-0249	24	14.10	11.50	13.40	12.60	
78119-0259	25	14.60	12.00	13.90	13.10	
78119-0269	26	15.10	12.50	14.40	13.60	
78119-0279	27	15.60	13.00	14.90	14.10	
78119-0289	28	16.10	13.50	15.40	14.60	
78119-0299	29	16.60	14.00	15.90	15.10	
78119-0309	30	17.10	14.50	16.40	15.60	

ASSY P/N W/O PACKAGING	CKT	DIM A	DIM B	DIM C	DIM D	PLATING TYPE
78119-0319	31	17.60	15.00	16.90	16.10	2
78119-0329	32	18.10	15.50	17.40	16.60	
78119-0339	33	18.60	16.00	17.90	17.10	
78119-0349	34	19.10	16.50	18.40	17.60	
78119-0359	35	19.60	17.00	18.90	18.10	
78119-0369	36	20.10	17.50	19.40	18.60	
78119-0379	37	20.60	18.00	19.90	19.10	
78119-0389	38	21.10	18.50	20.40	19.60	
78119-0399	39	21.60	19.00	20.90	20.10	
78119-0409	40	22.10	19.50	21.40	20.60	
78119-0419	41	22.60	20.00	21.90	21.10	
78119-0429	42	23.10	20.50	22.40	21.60	

E

E

D

D

C

C

B

B

A

A

REVISED EC NO: S2007-0721 DRWN: BOKOK CHKD: CGOH APPR: KCLING 2007/03/05 2007/03/05 2007/03/05	QUALITY SYMBOLS	GENERAL TOLERANCES (UNLESS SPECIFIED)	DIMENSION STYLE	SCALE	DESIGN UNITS	THIRD ANGLE PROJECTION
	$\nabla = 0$ $\nabla \text{C} = 0$	mm    INCH 4 PLACES ± --- ± --- 3 PLACES ± --- ± --- 2 PLACES ± 0.15 ± --- 1 PLACE ± --- ± --- ANGULAR ± 3 °	MM ONLY	NTS	METRIC	
	DESCRIPTION	DRAFT WHERE APPLICABLE MUST REMAIN WITHIN DIMENSIONS	DRAWN BY    DATE YLQ1A0    2006/04/11 CHECKED BY    DATE BOKOK    2006/04/18 APPROVED BY    DATE PTL IM    2006/04/18	TITLE	0.50MM PITCH, FPC CONN. NON-ZIF, SMT	
	REV	SIZE	SEE TABLE	MATERIAL NO. DOCUMENT NO.	MOLEX INCORPORATED SD-78119-001	SHEET NO.

9 8 7 6 5 4 3 2 1

10 9 8 7 6 5 4 3 2 1

F  
E  
D  
C  
B  
A

F  
E  
D  
C  
B  
A

EMBOSSED TYPE A

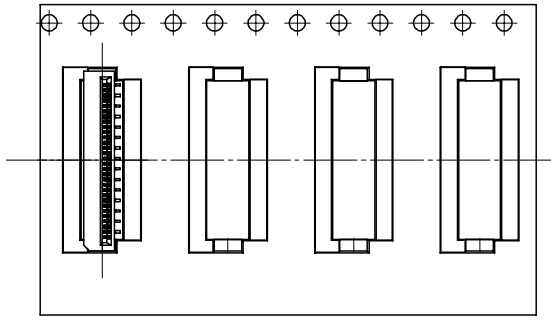

CUSTOMER  
PULL OUT DIRECTION

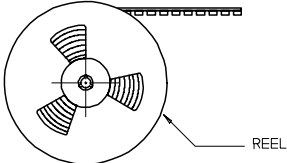

REEL

NOTES:

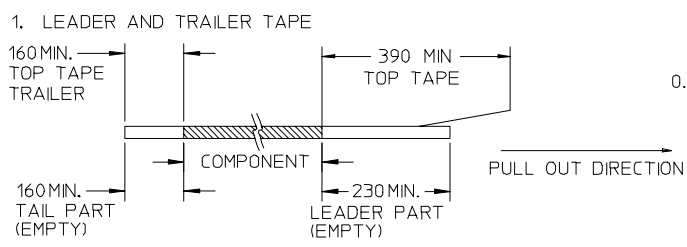

2. PEELING OFF FORCE OF THE TOP TAPE: 20-80gf.  
(PEELING DIRECTION AS SHOWN IN FOLLOWING FIGURE)

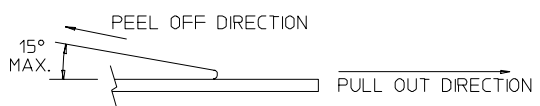

3. PACKAGING STANDARD IS AS PER EIA-481.  
4. TAPE & REEL QUANTITY = 1000 PCS/REEL

EMBOSSED TYPE B

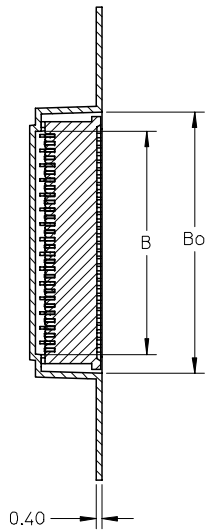
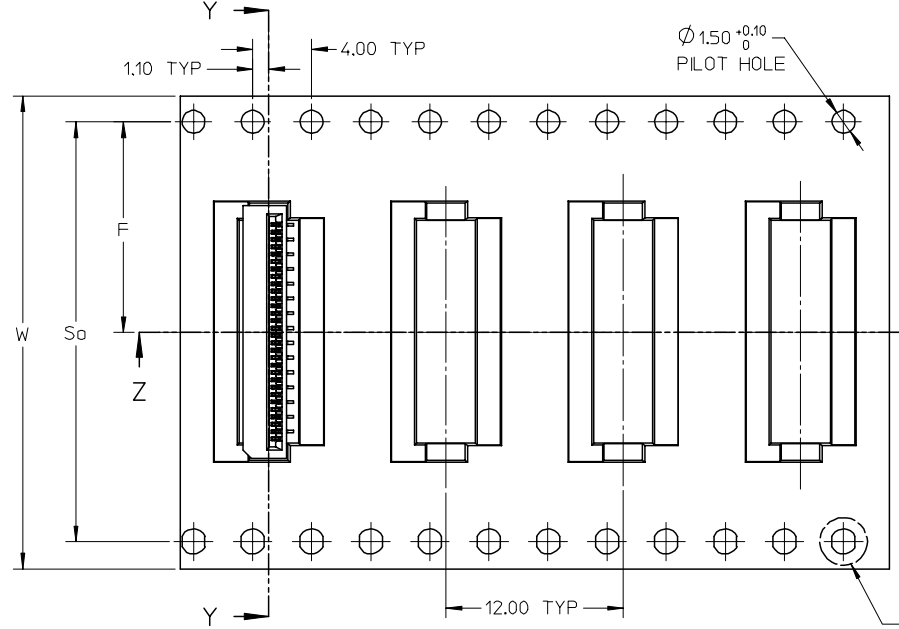

SECTION Y-Y

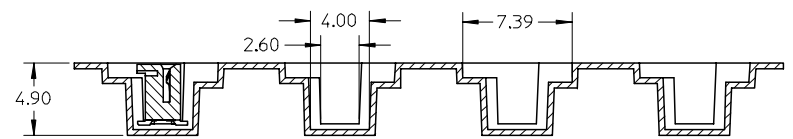

SECTION Z-Z

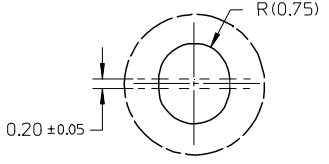

DETAIL 1

REVISED	DESCRIPTION
EC NO: S2007-0721	2007/03/05
DRWN: BOKOK	2007/03/05
CHKD: CGOH	2007/03/05
APPR: KCLING	2007/03/05
A2	REV

QUALITY SYMBOLS	$\nabla = 0$
	$\triangle = 0$

GENERAL TOLERANCES (UNLESS SPECIFIED)	
	mm
4 PLACES	$\pm 0.15$
3 PLACES	$\pm 0.20$
2 PLACES	$\pm 0.30$
1 PLACE	$\pm 0.40$
ANGULAR $\pm 3^\circ$	
DRAFT WHERE APPLICABLE MUST REMAIN WITHIN DIMENSIONS	

DIMENSION STYLE	
MM ONLY	
DRAWN BY	DATE
YLQ1A0	2006/04/11
CHECKED BY	DATE
BOKOK	2006/04/18
APPROVED BY	DATE
PTL IM	2006/04/18
MATERIAL NO.	
SEE TABLE	
SIZE	A3

SCALE	DESIGN UNITS	THIRD ANGLE PROJECTION	
NTS	METRIC		
TITLE		0.50MM PITCH, FPC CONN. NON-ZIF, SMT	
MOLEX INCORPORATED		DOCUMENT NO.	SHEET NO.
SD-78119-001			5 OF 7
THIS DRAWING CONTAINS INFORMATION THAT IS PROPRIETARY TO MOLEX INCORPORATED AND SHOULD NOT BE USED WITHOUT WRITTEN PERMISSION			

9 8 7 6 5 4 3 2 1

GOLD PLATING TERMINAL ASSEMBLY PART NUMBERS

ASSY P/N PACKED IN T&R	ASSY P/N W/O PACKAGING	CKT	W	So	F	Bo	B	EMBOSSED TYPE	ASSY P/N PACKED IN T&R	ASSY P/N W/O PACKAGING	CKT	W	So	F	Bo	B	EMBOSSED TYPE			
78119-1068	78119-0068	6	24.00	-	11.50	5.40	3.10	A	78119-1318	78119-0318	31	32.00	28.40	14.20	17.90	15.60	B			
78119-1078	78119-0078	7	24.00	-	11.50	5.90	3.60		78119-1328	78119-0328	32	32.00	28.40	14.20	18.40	16.10				
78119-1088	78119-0088	8	24.00	-	11.50	6.40	4.10		78119-1338	78119-0338	33	32.00	28.40	14.20	18.90	16.60				
78119-1098	78119-0098	9	24.00	-	11.50	6.90	4.60		78119-1348	78119-0348	34	32.00	28.40	14.20	19.40	17.10				
78119-1108	78119-0108	10	24.00	-	11.50	7.40	5.10		78119-1358	78119-0358	35	32.00	28.40	14.20	19.90	17.60				
78119-1118	78119-0118	11	24.00	-	11.50	7.90	5.60		78119-1368	78119-0368	36	32.00	28.40	14.20	20.40	18.10				
78119-1128	78119-0128	12	24.00	-	11.50	8.40	6.10		78119-1378	78119-0378	37	32.00	28.40	14.20	20.90	18.60				
78119-1138	78119-0138	13	24.00	-	11.50	8.90	6.60		78119-1388	78119-0388	38	32.00	28.40	14.20	21.40	19.10				
78119-1148	78119-0148	14	24.00	-	11.50	9.40	7.10		78119-1398	78119-0398	39	44.00	40.40	20.20	21.90	19.60				
78119-1158	78119-0158	15	24.00	-	11.50	9.90	7.60		78119-1408	78119-0408	40	44.00	40.40	20.20	22.40	20.10				
78119-1168	78119-0168	16	24.00	-	11.50	10.40	8.10		78119-1418	78119-0418	41	44.00	40.40	20.20	22.90	20.60				
78119-1178	78119-0178	17	24.00	-	11.50	10.90	8.60		78119-1428	78119-0428	42	44.00	40.40	20.20	23.40	21.10				
78119-1188	78119-0188	18	24.00	-	11.50	11.40	9.10													
78119-1198	78119-0198	19	24.00	-	11.50	11.90	9.60													
78119-1208	78119-0208	20	24.00	-	11.50	12.40	10.10													
78119-1218	78119-0218	21	32.00	28.40	14.20	12.90	10.60		B											
78119-1228	78119-0228	22	32.00	28.40	14.20	13.40	11.10													
78119-1238	78119-0238	23	32.00	28.40	14.20	13.90	11.60													
78119-1248	78119-0248	24	32.00	28.40	14.20	14.40	12.10													
78119-1258	78119-0258	25	32.00	28.40	14.20	14.90	12.60													
78119-1268	78119-0268	26	32.00	28.40	14.20	15.40	13.10													
78119-1278	78119-0278	27	32.00	28.40	14.20	15.90	13.60													
78119-1288	78119-0288	28	32.00	28.40	14.20	16.40	14.10													
78119-1298	78119-0298	29	32.00	28.40	14.20	16.90	14.60													
78119-1308	78119-0308	30	32.00	28.40	14.20	17.40	15.10													

REVISED EC NO: S2007-0721 DRWN: BOKOK CHKD: CGOH APPR: KCLING 2007/03/05 2007/03/05 2007/03/05	QUALITY SYMBOLS	GENERAL TOLERANCES (UNLESS SPECIFIED)	DIMENSION STYLE	SCALE	DESIGN UNITS	THIRD ANGLE PROJECTION
	$\nabla = 0$ $\triangle = 0$	mm    INCH 4 PLACES ± --- ± --- 3 PLACES ± --- ± --- 2 PLACES ± 0.15 ± --- 1 PLACE ± --- ± --- ANGULAR ± 3°	MM ONLY	NTS	METRIC	TITLED 0.50MM PITCH, FPC CONN. NON-ZIF, SMT
	DESCRIPTION	DRAFT WHERE APPLICABLE MUST REMAIN WITHIN DIMENSIONS	DRAWN BY    DATE YLQIAO    2006/04/11 CHECKED BY    DATE BOKOK    2006/04/18 APPROVED BY    DATE PTLIM    2006/04/18			MOLEX INCORPORATED DOCUMENT NO. SD-78119-001
	REV		SIZE A3	SEE TABLE		SHEET NO. 6 OF 7



TIN-BISMUTH PLATING TERMINAL ASSEMBLY PART NUMBERS

ASSY P/N PACKED IN T&R	ASSY P/N W/O PACKAGING	CKT	W	So	F	Bo	B	EMBOSSSED TYPE	ASSY P/N PACKED IN T&R	ASSY P/N W/O PACKAGING	CKT	W	So	F	Bo	B	EMBOSSSED TYPE			
78119-1069	78119-0069	6	24.00	-	11.50	5.40	3.10	A	78119-1319	78119-0319	31	32.00	28.40	14.20	17.90	15.60	B			
78119-1079	78119-0079	7	24.00	-	11.50	5.90	3.60		78119-1329	78119-0329	32	32.00	28.40	14.20	18.40	16.10				
78119-1089	78119-0089	8	24.00	-	11.50	6.40	4.10		78119-1339	78119-0339	33	32.00	28.40	14.20	18.90	16.60				
78119-1099	78119-0099	9	24.00	-	11.50	6.90	4.60		78119-1349	78119-0349	34	32.00	28.40	14.20	19.40	17.10				
78119-1109	78119-0109	10	24.00	-	11.50	7.40	5.10		78119-1359	78119-0359	35	32.00	28.40	14.20	19.90	17.60				
78119-1119	78119-0119	11	24.00	-	11.50	7.90	5.60		78119-1369	78119-0369	36	32.00	28.40	14.20	20.40	18.10				
78119-1129	78119-0129	12	24.00	-	11.50	8.40	6.10		78119-1379	78119-0379	37	32.00	28.40	14.20	20.90	18.60				
78119-1139	78119-0139	13	24.00	-	11.50	8.90	6.60		78119-1389	78119-0389	38	32.00	28.40	14.20	21.40	19.10				
78119-1149	78119-0149	14	24.00	-	11.50	9.40	7.10		78119-1399	78119-0399	39	44.00	40.40	20.20	21.90	19.60				
78119-1159	78119-0159	15	24.00	-	11.50	9.90	7.60		78119-1409	78119-0409	40	44.00	40.40	20.20	22.40	20.10				
78119-1169	78119-0169	16	24.00	-	11.50	10.40	8.10		78119-1419	78119-0419	41	44.00	40.40	20.20	22.90	20.60				
78119-1179	78119-0179	17	24.00	-	11.50	10.90	8.60		78119-1429	78119-0429	42	44.00	40.40	20.20	23.40	21.10				
78119-1189	78119-0189	18	24.00	-	11.50	11.40	9.10													
78119-1199	78119-0199	19	24.00	-	11.50	11.90	9.60													
78119-1209	78119-0209	20	24.00	-	11.50	12.40	10.10													
78119-1219	78119-0219	21	32.00	28.40	14.20	12.90	10.60		B											
78119-1229	78119-0229	22	32.00	28.40	14.20	13.40	11.10													
78119-1239	78119-0239	23	32.00	28.40	14.20	13.90	11.60													
78119-1249	78119-0249	24	32.00	28.40	14.20	14.40	12.10													
78119-1259	78119-0259	25	32.00	28.40	14.20	14.90	12.60													
78119-1269	78119-0269	26	32.00	28.40	14.20	15.40	13.10													
78119-1279	78119-0279	27	32.00	28.40	14.20	15.90	13.60													
78119-1289	78119-0289	28	32.00	28.40	14.20	16.40	14.10													
78119-1299	78119-0299	29	32.00	28.40	14.20	16.90	14.60													
78119-1309	78119-0309	30	32.00	28.40	14.20	17.40	15.10													

REVISED EC NO: S2007-0721 DRWN: BOKOK CHKD: CGOH APPR: KCLING 2007/03/05 2007/03/05 2007/03/05	QUALITY SYMBOLS	GENERAL TOLERANCES (UNLESS SPECIFIED)	DIMENSION STYLE	SCALE	DESIGN UNITS	THIRD ANGLE PROJECTION
	$\nabla = 0$ $\triangle = 0$	mm INCH 4 PLACES ± --- ± --- 3 PLACES ± --- ± --- 2 PLACES ± 0.15 ± --- 1 PLACE ± --- ± --- ANGULAR ± 3°	MM ONLY	NTS	METRIC	TITLED 0.50MM PITCH, FPC CONN. NON-ZIF, SMT
	DESCRIPTION	DRAFT WHERE APPLICABLE MUST REMAIN WITHIN DIMENSIONS	DRAWN BY DATE YLQIAO 2006/04/11 CHECKED BY DATE BOKOK 2006/04/18 APPROVED BY DATE PTL IM 2006/04/18	MOLEX INCORPORATED SD-78119-001		SHEET NO. 7 OF 7
	REV	SIZE A3	THIS DRAWING CONTAINS INFORMATION THAT IS PROPRIETARY TO MOLEX INCORPORATED AND SHOULD NOT BE USED WITHOUT WRITTEN PERMISSION			