

LED Drive Application.

FEATURES

- Supplies stable bias current even at low battery voltage.
- Ideal for stabilizing bias current of LEDs.
- Negative temperature coefficient protects LEDs against thermal overload.

EQUIVALENT CIRCUIT

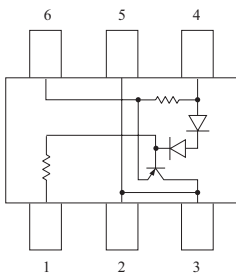

MARKING

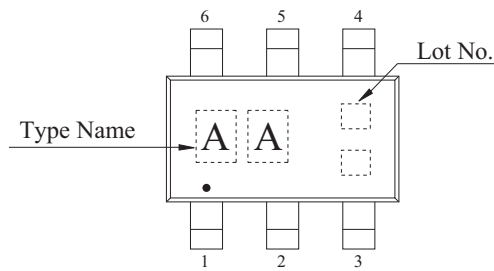

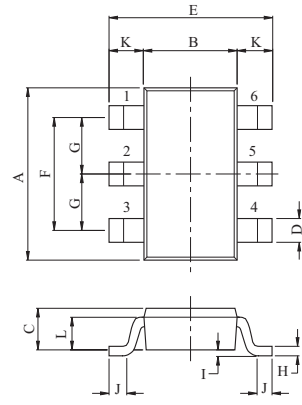

DIM	MILLIMETERS
A	2.9±0.2
B	1.6+0.2/-0.1
C	0.70±0.05
D	0.4±0.1
E	2.8+0.2/-0.3
F	1.9±0.2
G	0.95
H	0.16±0.05
I	0.00-0.10
J	0.25+0.25/-0.15
K	0.60
L	0.55

1. GND
 2. Output Current
 3. Output Current
 4. Source Voltage
 5. Output Current
 6. Rext

TS6

MAXIMUM RATING (Ta=25 °C)

CHARACTERISTIC	SYMBOL	RATING	UNIT
Source Voltage	V_S	40	V
Output Current	I_O	65	mA
Output Voltage	V_O	38	V
Reverse Voltage Between All Terminals	V_R	0.5	V
Power Dissipation	P_D^*	900	mW
Junction Temperature	T_j	150	°C
Storage Temperature Range	T_{stg}	-55 ~ 150	°C

*Package mounted on a ceramic board (600mm² × 0.8mm)

KCR402T

ELECTRICAL CHARACTERISTICS (Ta=25 °C)

CHARACTERISTIC	SYMBOL	TEST CONDITION	MIN.	TYP.	MAX.	UNIT
Collector-Emitter Breakdown Voltage	BV_{CEO}	$I_C=1mA, I_B=0$	40	-	-	V
Supply Current	I_S	$V_S=10V$	340	420	500	μA
DC Current Gain	h_{FE}	$I_C=50mA, V_{CE}=1V$	100	220	470	-
Internal Resistor	R_{int}	$I_{Rint}=20mA$	37	44	53	
Output Current	I_O	$V_S=10V, V_{OUT}=8.6V$	18	20	22	mA
Voltage Drop (V_S-V_E)	V_{Drop}	$I_O=20mA$	0.8	0.85	0.9	V
Lowest Sufficient Battery Voltage Overhead	V_{Smin}	$I_O>18mA$	-	1.4	-	V
Output Current Change Versus Ta	I_O/I_O	$V_S=10V$	-	-0.2	-	%/K
Output Current Change Versus V_S	I_O/I_O	$V_S=10V$	-	1	-	%/V

APPLICATION CIRCUIT

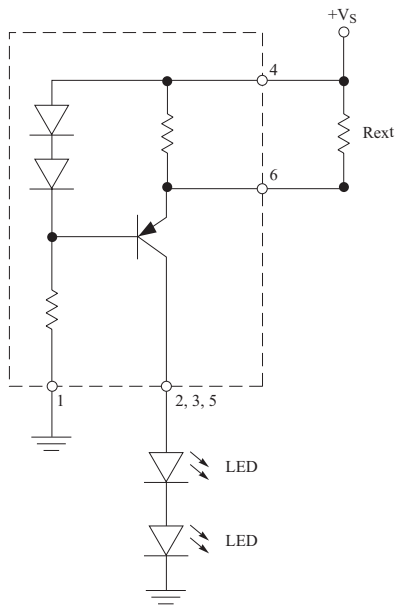

KCR402T

$I_O - V_S$

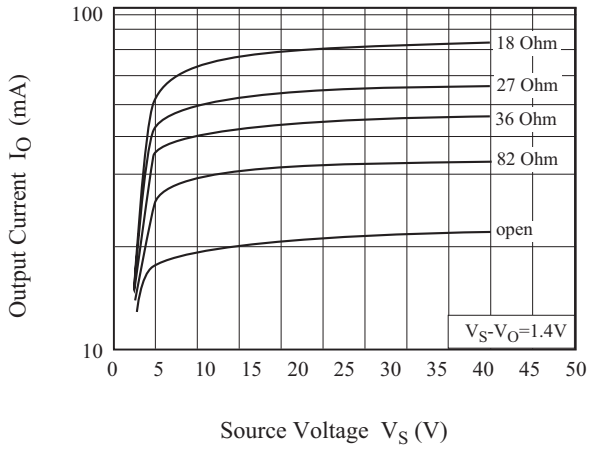

$I_S - V_S$

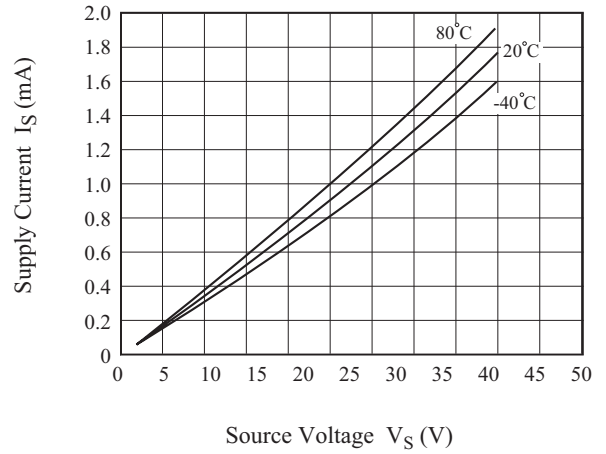

$I_O - V_S$

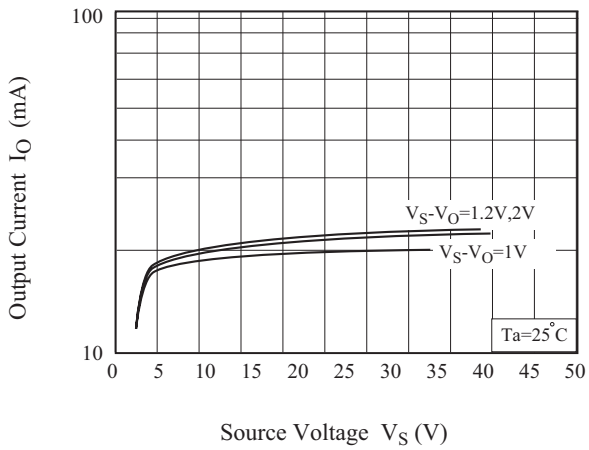

$I_O - V_S$

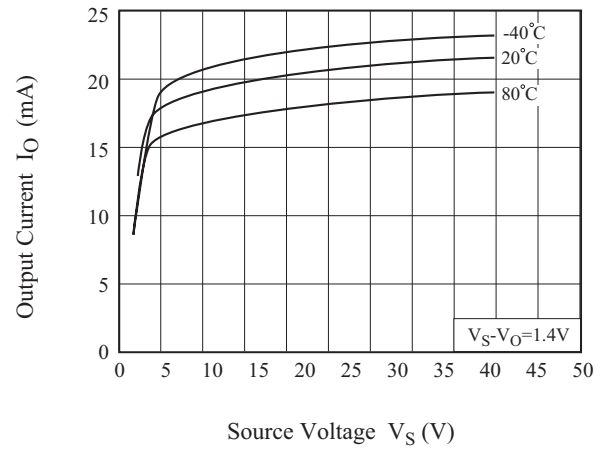

$I_O - R_{ext}$

