

Technical Data

MBC13900/D
Rev. 0, 06/2002

NPN Silicon
Low Noise Transistor



MBC13900



(Scale 2:1)

Package Information

Plastic Package
Case 318M
(SOT-343)

Ordering Information

Device	Marking	Package
MBC13900T1	900	SOT-343

The MBC13900 is a high performance transistor fabricated using Motorola's 15 GHz f_t bipolar IC process. It is housed in the 4-lead SC-70 (SOT-343) surface mount plastic package resulting in a parasitic effect reduction and RF performance enhancements. The high performance at low power makes the MBC13900 suitable for front-end applications in portable wireless systems such as pagers, cellular and cordless phones.

- Low Noise Figure, $NF_{min} = 0.8$ dB (Typ) @ 0.9 GHz, 2.0 V and 5.0 mA
- Maximum Stable Gain, 22 dB @ 0.9 GHz, 2.0 V and 5.0 mA
- Output Third Order Intercept, $OIP3 = 18$ dBm (Typ) @ 2.0 V and 5.0 mA
- Ultra small SOT-343 Surface Mount Package
- Available Only in Tape and Reel Packaging

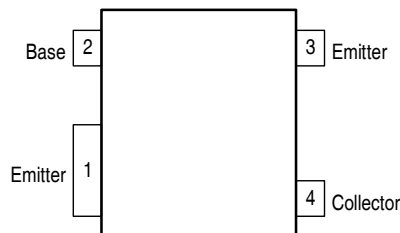

Figure 1. Pin Connections

Definitive Data: Motorola reserves the right to change the Production detail specifications as may be required to permit improvements in the design of its product. © Motorola, Inc., 2002. All rights reserved.

1 Electrical Specifications

Table 1. Maximum Ratings

Rating	Symbol	Value	Unit
Collector-Emitter Voltage	V_{CEO}	6.5	Vdc
Collector-Base Voltage	V_{CBO}	8.0	Vdc
Emitter-Base Voltage	V_{EBO}	3.0	Vdc
Power Dissipation @ $T_C = 75\text{ C}$ Derate Linearly above $T_C = 75\text{ C}$ at	$P_{D(max)}$	0.188 2.5	W mW/ C
Collector Current-Continuous	I_C	20	mA
Maximum Junction Temperature	$T_{J(max)}$	150	C
Storage Temperature	T_{stg}	-55 to 150	C

NOTES: 1. Maximum Ratings are those values beyond which damage to the device may occur. Functional operation should be restricted to the limits in the Electrical Characteristics or Recommended Operating Conditions tables.
2. ESD (electrostatic discharge) immunity meets Human Body Model (HBM) $\leq 400\text{ V}$ and Machine Model (MM) $\leq 50\text{ V}$. Additional ESD data available upon request.

Table 2. Thermal Characteristic

Characteristic	Symbol	Max	Unit
Thermal Resistance, Junction-to-Case	$R_{\theta JC}$	400	C/W

NOTES: To calculate the junction temperature use $T_J = (P_D \times R_{\theta JC}) + T_C$. The case temperature measured on collector lead adjacent to the package body.

Table 3. Electrical Characteristics

Characteristic	Symbol	Min	Typ	Max	Unit
OFF Characteristic [Note 1]					
Collector-Emitter Breakdown Voltage ($I_C = 0.1\text{ mA}$, $I_B = 0$)	$V_{(BR)CEO}$	6.5	7.5	-	Vdc
Collector-Base Breakdown Voltage ($I_C = 0.1\text{ mA}$, $I_E = 0$)	$V_{(BR)CBO}$	8.0	12	-	Vdc
Emitter-Base Breakdown Voltage ($I_E = 0.1\text{ mA}$, $I_C = 0$)	$V_{(BR)EBO}$	3.0	4.0	-	Vdc
Collector Cutoff Current ($V_{CB} = 7.0\text{ V}$, $I_E = 0$)	I_{CBO}	-	-	0.1	$\infty\text{ A}$
Emitter Cutoff Current ($V_{EB} = 2.0\text{ V}$, $I_C = 0$)	I_{EBO}	-	-	0.1	$\infty\text{ A}$
Base Cutoff Current ($V_{CE} = 5.0\text{ V}$, $I_B = 0$)	I_{CEO}	-	-	0.1	$\infty\text{ A}$
ON Characteristic [Note 1]					
DC Current Gain ($V_{CE} = 2.0\text{ V}$, $I_C = 5.0\text{ mA}$)	h_{FE}	100	-	200	-

Table 3. Electrical Characteristics (Continued)

Characteristic	Symbol	Min	Typ	Max	Unit
Dynamic Characteristics					
Current Gain Bandwidth Product ($V_{CE} = 2.0\text{ V}$, $I_C = 15\text{ mA}$, $f = 0.9\text{ GHz}$)	f_t	-	15	-	GHz
Performance Characteristic					
Insertion Gain $V_{CE} = 2.0\text{ V}$, $I_C = 5.0\text{ mA}$, $f = 0.9\text{ GHz}$ $V_{CE} = 2.0\text{ V}$, $I_C = 5.0\text{ mA}$, $f = 1.9\text{ GHz}$ $V_{CE} = 3.0\text{ V}$, $I_C = 3.0\text{ mA}$, $f = 0.9\text{ GHz}$ $V_{CE} = 3.0\text{ V}$, $I_C = 3.0\text{ mA}$, $f = 1.9\text{ GHz}$	$ S_{21} ^2$	18.5 13.5 16.5 12.5	19.5 14.5 17.5 13.5	- - - -	dB
Maximum Stable Gain and/or Maximum Available Gain [Note 2] $V_{CE} = 2.0\text{ V}$, $I_C = 5.0\text{ mA}$, $f = 0.9\text{ GHz}$ $V_{CE} = 2.0\text{ V}$, $I_C = 5.0\text{ mA}$, $f = 1.9\text{ GHz}$ $V_{CE} = 3.0\text{ V}$, $I_C = 3.0\text{ mA}$, $f = 0.9\text{ GHz}$ $V_{CE} = 3.0\text{ V}$, $I_C = 3.0\text{ mA}$, $f = 1.9\text{ GHz}$	MSG, MAG	22 18 21 17.5	23 19 22 18.5	- - - -	dB
Minimum Noise Figure $V_{CE} = 2.0\text{ V}$, $I_C = 5.0\text{ mA}$, $f = 0.9\text{ GHz}$ $V_{CE} = 2.0\text{ V}$, $I_C = 5.0\text{ mA}$, $f = 1.9\text{ GHz}$ $V_{CE} = 3.0\text{ V}$, $I_C = 3.0\text{ mA}$, $f = 0.9\text{ GHz}$ $V_{CE} = 3.0\text{ V}$, $I_C = 3.0\text{ mA}$, $f = 1.9\text{ GHz}$	NF_{min}	- - - -	0.8 0.9 0.8 0.9	0.9 1.1 0.9 1.1	dB
Associated Gain at Minimum Noise Figure $V_{CE} = 2.0\text{ V}$, $I_C = 5.0\text{ mA}$, $f = 0.9\text{ GHz}$ $V_{CE} = 2.0\text{ V}$, $I_C = 5.0\text{ mA}$, $f = 1.9\text{ GHz}$ $V_{CE} = 3.0\text{ V}$, $I_C = 3.0\text{ mA}$, $f = 0.9\text{ GHz}$ $V_{CE} = 3.0\text{ V}$, $I_C = 3.0\text{ mA}$, $f = 1.9\text{ GHz}$	G_{NF}	- - - -	22 16 21 15	- - - -	dB
Output Third Order Intercept [Note 3] $(V_{CE} = 2.0\text{ V}$, $I_C = 5.0\text{ mA}$, $f = 0.9\text{ GHz})$ $(V_{CE} = 2.0\text{ V}$, $I_C = 5.0\text{ mA}$, $f = 1.9\text{ GHz})$ $(V_{CE} = 3.0\text{ V}$, $I_C = 3.0\text{ mA}$, $f = 0.9\text{ GHz})$ $(V_{CE} = 3.0\text{ V}$, $I_C = 3.0\text{ mA}$, $f = 1.9\text{ GHz})$	OIP3	- - - -	18 21 13.5 19	- - - -	dBm

NOTES: 1. Pulse width $\leq 300\text{ }\mu\text{s}$, duty cycle $\leq 2\%$ pulsed.
2. Maximum Available Gain and Maximum Stable Gain are defined by the K factor as follows:

$$MAG = \left| \frac{S_{21}}{S_{12}} \left(K \pm \sqrt{K^2 - 1} \right) \right|, \text{ if } K > 1, \text{ MSG} = \left| \frac{S_{21}}{S_{12}} \right|, \text{ if } K < 1$$

3. Z_{in} and Z_{out} matched for optimum IP3.

2 Typical Performance Characteristics

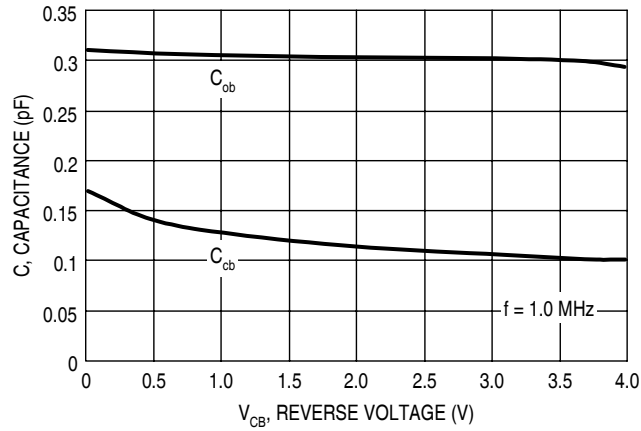

Figure 2. Capacitance versus Voltage

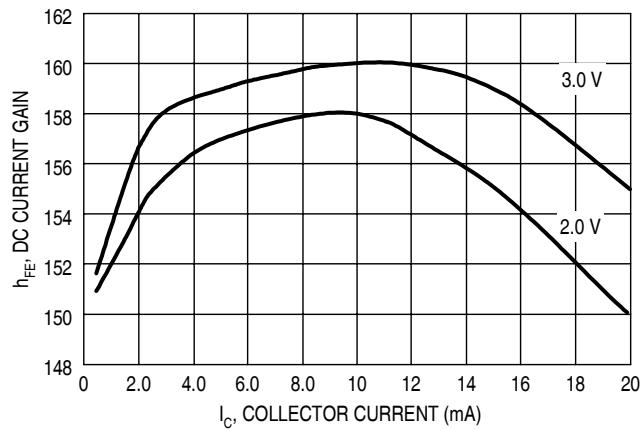

Figure 3. h_{FE} , DC Current Gain versus Collector Current

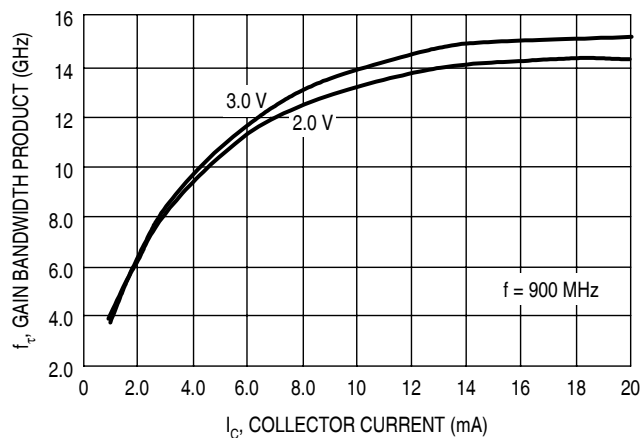

Figure 4. Gain-Bandwidth Product versus Collector Current

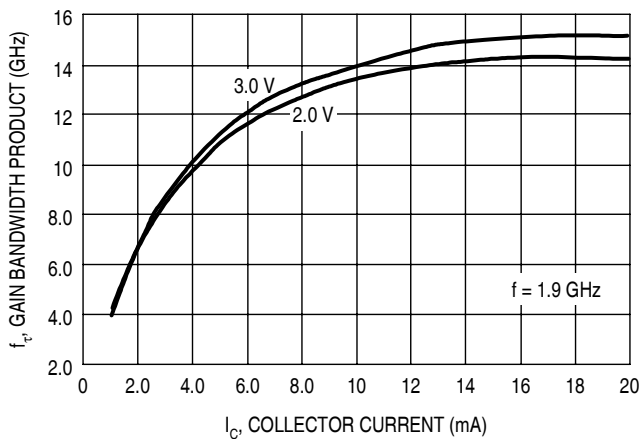

Figure 5. Gain-Bandwidth Product versus Collector Current

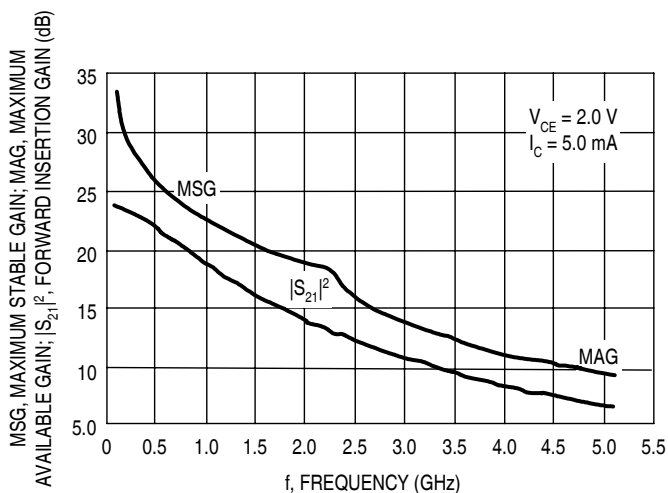

Figure 6. Maximum Stable/Available gain and Forward Insertion Gain versus Frequency

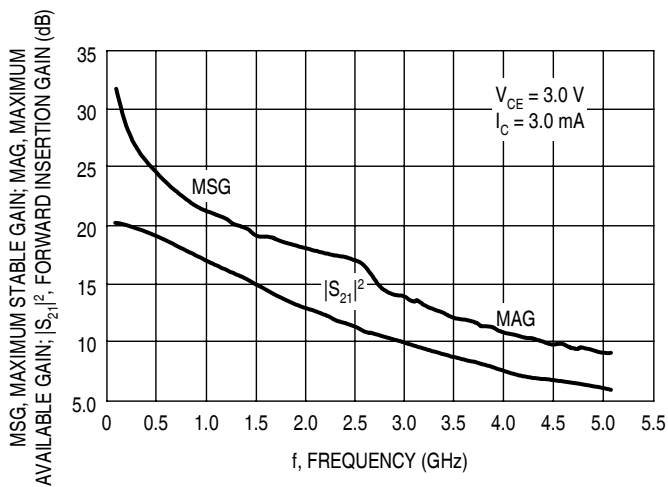

Figure 7. Maximum Stable/Available gain and Forward Insertion Gain versus Frequency

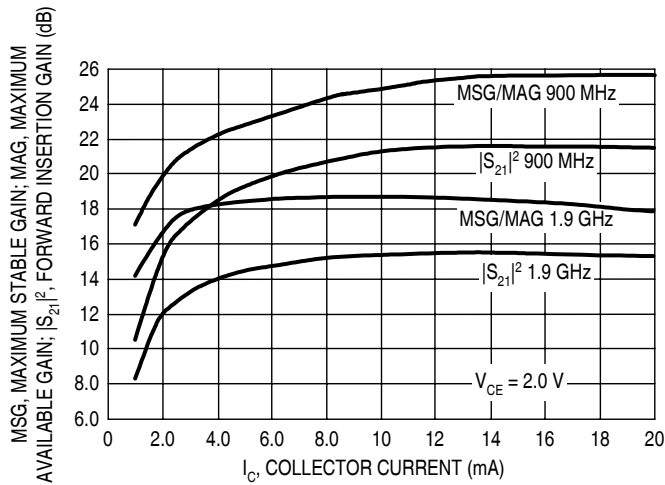

Figure 8. Maximum Stable/Available gain and Forward Insertion Gain versus Collector Current

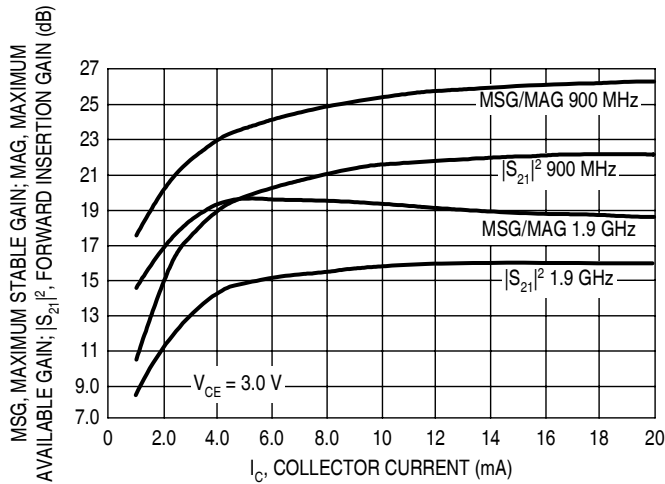

Figure 9. Maximum Stable/Available gain and Forward Insertion Gain versus Collector Current

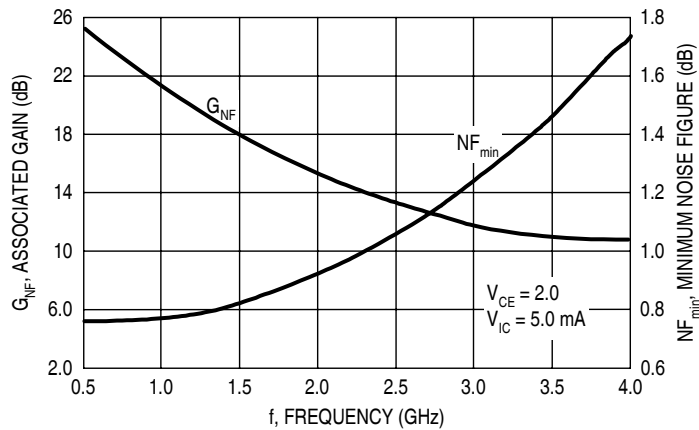

Figure 10. Minimum Noise Figure and Associated Gain versus Frequency

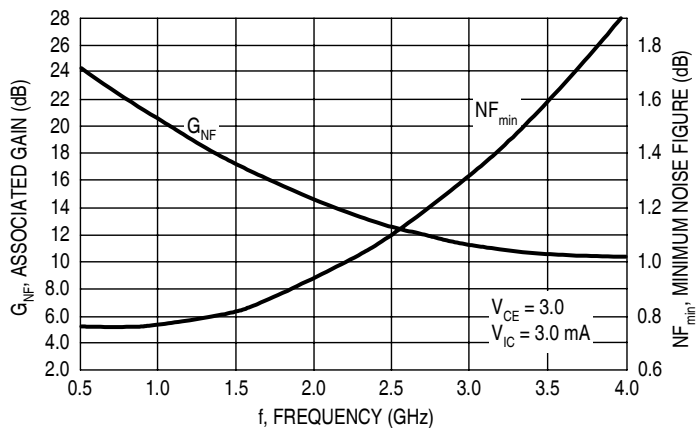

Figure 11. Minimum Noise Figure and Associated Gain versus Frequency

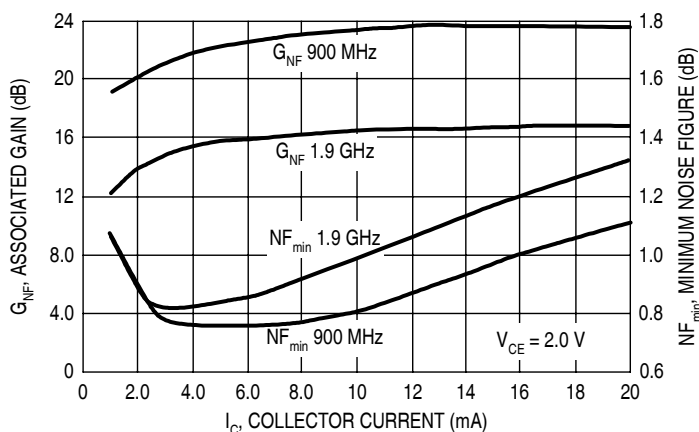

Figure 12. Minimum Noise Figure and Associated Gain versus Collector Current

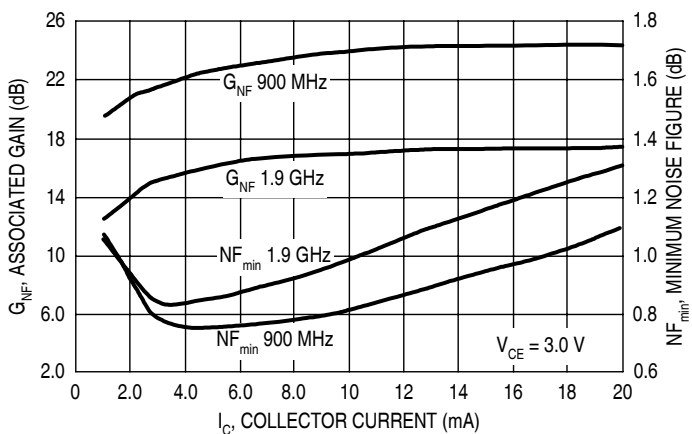

Figure 13. Minimum Noise Figure and Associated Gain versus Collector Current

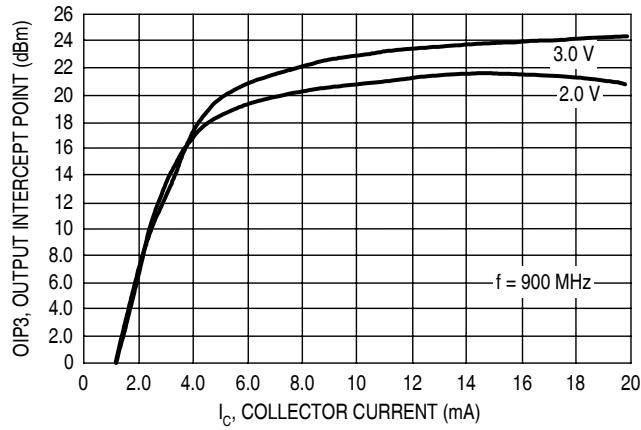

Figure 14. Output Third Order Intercept versus Collector Current

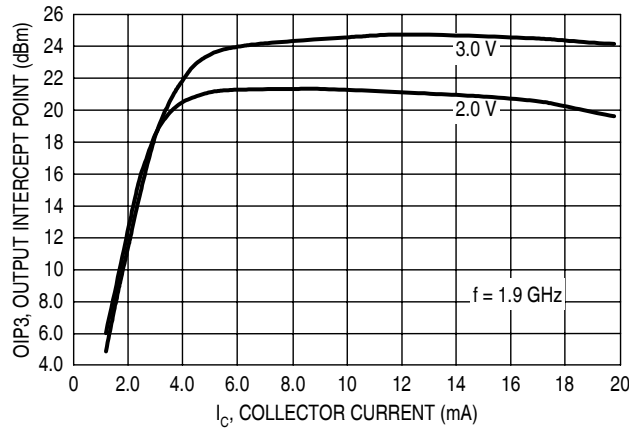

Figure 15. Output Third Order Intercept versus Collector Current

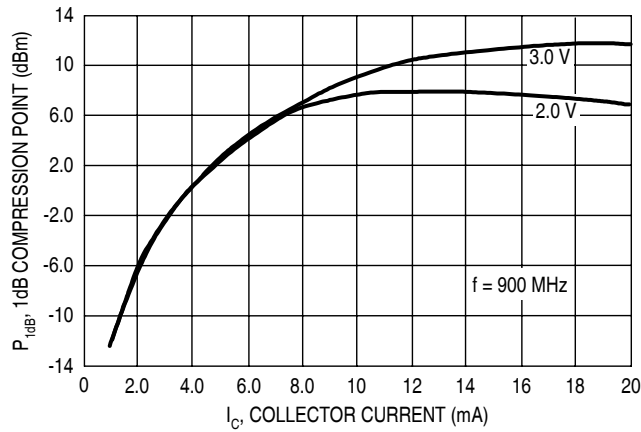

Figure 16. One dB Compression Point versus Collector Current

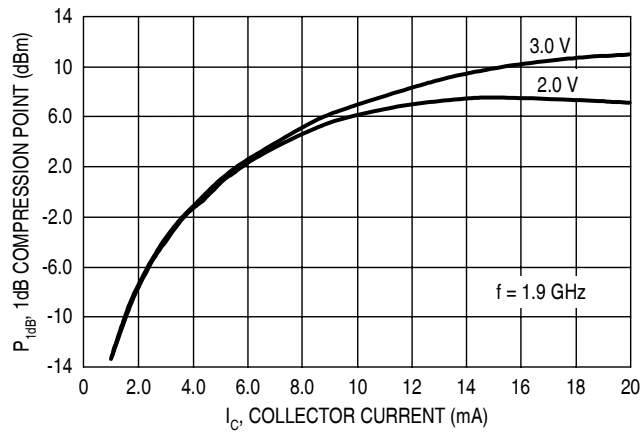

Figure 17. One dB Compression Point versus Collector Current

3 Applications Information

A flexible applications board topology has been developed to demonstrate the performance of the MBC13900 at 900 and 1900 MHz. The designs are a compromise of the competing performance requirements of gain, noise figure, input third-order intercept point (IIP3) and return losses. PCB, samples and assembly information are available from Motorola under part number KITMBC13900/D.

3.1 900 MHz LNA

Figure 18 shows the schematic and Figure 19 shows the component placement for a 900 MHz LNA. The design goals for the circuit are:

NF < 1.2 dB

Gain > 19 dB

Return Loss > 10 dB, input and output

Unconditional stability from 100 MHz to 6 GHz.

Typical performance that can be expected from this circuit at 3.0 and 3.5 V V_{CC} is listed in Table 4. The component values can be changed to enhance the performance of a particular parameter but usually at the expense of another. Gain can be improved by sacrificing stability (R3 and R5). Input return loss can be sacrificed to improve noise figure. IIP3 can be improved by increasing emitter degeneration (L3) and bias current (R2). Unused traces are available on the PCB to add emitter degeneration at leads 1 and 3 of the device.

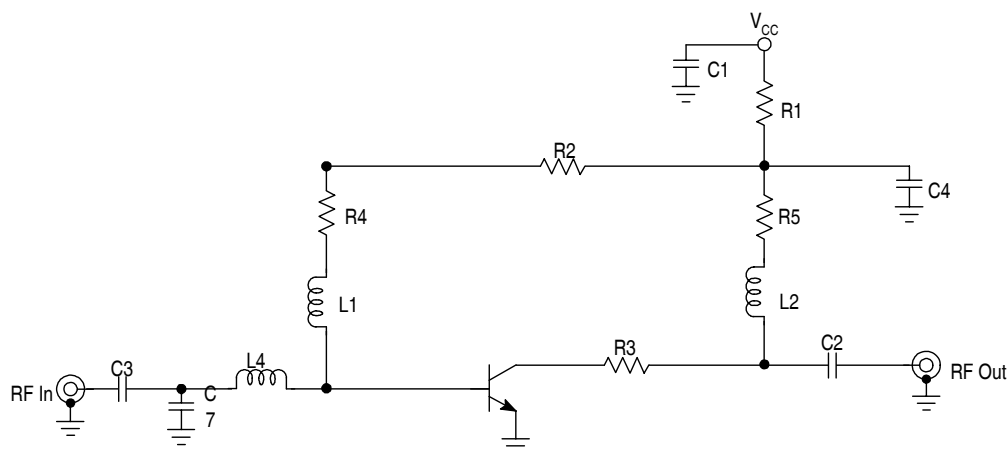
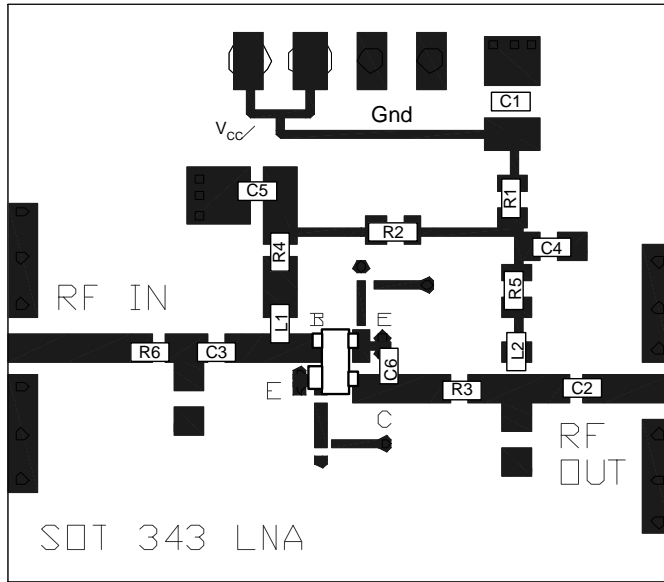

Figure 18. 900 MHz LNA Schematic



Component	Value	Comments
C1	1.0 μ F	Optional Bypassing
C2	3.3 pF	DC Block and S_{22}
C3	12 pF	DC Block and S_{11}
C4	0.01 μ F	Broadband bypass
C5	1.0 μ F	Broadband bypass
C6	0.3 pF	IIP3 improvement
L1	6.8 nH	Toko LL1608-FS, match, bias
L2	5.6 nH	Toko LL1608-FH, match, bias
L3	<0.5 nH	Emitter L on board (distance to GND vias)
R1	133 Ω	Bias
R2	49.9 k Ω	Bias
R3	16.5 Ω	Stability, S_{22}
R4	0 Ω	Jumper
R5	3.9 Ω	Stability, S_{22}
R6	0 Ω	Jumper
Vias	D = 15 mil	
PCB	FR4	$\epsilon_r=4.5$, h=25 mil, t=1.75 mil

Figure 19. 900 MHz LNA Board Layout

Table 4. Typical 900 MHz LNA Performance

V_{CC}	I_C (mA)	NF (dB)	50 Ω Insertion Gain (dB)	Output IP3 (dBm)	Input Return Loss (dB)	Output Return Loss (dB)
3.0	5.0	1.2	19.7	15	10.1	10.2
3.5	6.1	1.21	20.2	17.6	10.8	10.8

3.2 1900 MHz LNA

Figure Figure 20 shows the schematic and Figure 21 shows the component placement for a 1900 MHz LNA. The design goals for the circuit are:

NF < 1.35 dB

Gain > 14 dB

Return Loss > 10 dB, input and output

Unconditional stability from 100 MHz to 6 GHz.

Typical performance that can be expected from this circuit at 3.0 V V_{CC} and 5.0 mA is listed in Table 5. The component values can be changed to enhance the performance of a particular parameter but usually at the expense of another. Gain can be improved by sacrificing stability (R3 and R5). Input return loss can be sacrificed to improve noise figure. Input return loss can be improved at the expense of noise figure (C3, C7, L4). IIP3 can be improved by increasing emitter degeneration (L3) and bias current (R2). Unused traces are available on the PCB to add emitter degeneration at leads 1 and 3 of the device.

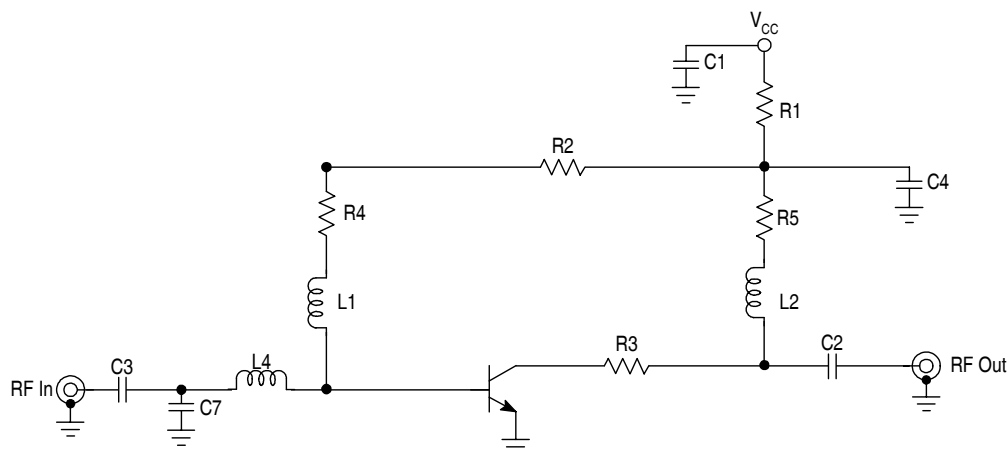
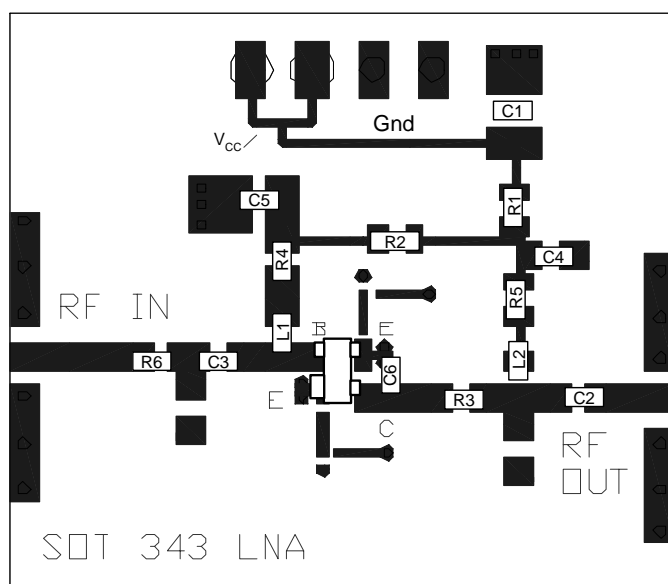

Figure 20. 1900 MHz LNA Schematic



Component	Value	Comments
C1	1.0 μ F	Optional Bypassing
C2	22 pF	DC Block and output match
C3	22 pF	DC Block and input match
C4	0.01 μ F	RF and IM subharmonic short to ground
C5	1.0 μ F	RF and IM subharmonic short to ground
C7	0.6 pF	Input match, RF / S_{11} compromise
L1	8.2 nH	Bias decoupling, input match
L2	3.3 nH	Output match, bias decoupling
L3	<0.5 nH	Emitter L on board (distance to GND vias)
L4	1.2 nH	S_{11}
R1	133 Ω	Bias
R2	49.9 k Ω	Bias
R3	8.2 Ω	Stability and S_{22} improvement
R4	0 Ω	Jumper
R5	4.7 Ω	Stability, Gain, S_{22}
Vias	D = 15 mil	
PCB	FR4	$\epsilon_r=4.5$, h=25 mil, t=1.75 mil

Figure 21. 1900 MHz LNA Board Layout

Table 5. Typical 1900 MHz LNA Performance

V_{CC}	I_C (mA)	NF (dB)	50 Ω Insertion Gain (dB)	Output IP3 (dBm)	Input Return Loss (dB)	Output Return Loss (dB)
3.0	5.0	1.28	14	19	10.4	10.7
3.5	6.1	1.29	14.4	20.2	10.8	11

Table 6. Common Emitter S-Parameters

V _{CE} (Vdc)	I _C (mA)	f (MHz)	S ₁₁		S ₂₁		S ₁₂		S ₂₂	
			S ₁₁	∠φ	S ₂₁	∠φ	S ₁₂	∠φ	S ₂₂	∠φ
2.0	1.0	0.1	0.973	-6	3.754	175	0.008	86	0.997	-3
		0.5	0.961	-33	3.366	153	0.038	71	0.968	-12
		0.9	0.895	-57	3.341	135	0.065	56	0.910	-22
		1.0	0.868	-63	3.256	131	0.070	53	0.915	-24
		1.5	0.766	-91	2.688	111	0.091	38	0.851	-33
		1.9	0.721	-114	2.610	94	0.100	26	0.788	-39
		2.0	0.706	-119	2.501	91	0.102	23	0.780	-41
		2.4	0.649	-140	2.280	77	0.104	15	0.731	-47
		3.0	0.628	-166	1.984	58	0.105	2	0.667	-56
		3.5	0.606	173	1.717	45	0.099	-3	0.650	-62
		4.0	0.606	155	1.478	33	0.094	-10	0.640	-68
		4.5	0.611	138	1.421	21	0.089	-12	0.604	-74
		5.0	0.610	122	1.309	9	0.085	-11	0.581	-81
	2.0	0.1	0.948	-8	7.181	173	0.008	86	0.993	-4
		0.5	0.907	-41	6.508	146	0.037	67	0.937	-15
		0.9	0.796	-70	5.770	126	0.059	52	0.843	-27
		1.0	0.763	-77	5.533	121	0.062	49	0.842	-29
		1.5	0.638	-107	4.304	101	0.076	36	0.753	-37
		1.9	0.585	-131	3.904	86	0.082	27	0.675	-42
		2.0	0.571	-136	3.716	83	0.083	25	0.667	-44
		2.4	0.532	-156	3.272	70	0.085	20	0.616	-48
		3.0	0.520	179	2.745	53	0.087	13	0.554	-57
		3.5	0.511	159	2.360	41	0.088	10	0.542	-62
		4.0	0.518	143	2.046	30	0.088	7	0.530	-67
		4.5	0.529	128	1.907	19	0.091	5	0.500	-72
		5.0	0.536	114	1.747	8	0.096	5	0.474	-78
	3.0	0.1	0.926	-10	10.121	172	0.008	84	0.990	-4
0.5		0.853	-48	8.944	141	0.035	65	0.906	-18	

Table 6. Common Emitter S-Parameters (Continued)

V _{CE} (Vdc)	I _C (mA)	f (MHz)	S ₁₁		S ₂₁		S ₁₂		S ₂₂	
			S ₁₁	∠φ	S ₂₁	∠φ	S ₁₂	∠φ	S ₂₂	∠φ
		0.9	0.716	-80	7.393	120	0.053	49	0.786	-30
		1.0	0.680	-87	7.000	115	0.056	47	0.780	-31
		1.5	0.556	-118	5.248	95	0.068	36	0.685	-38
		1.9	0.507	-141	4.579	81	0.073	31	0.609	-43
		2.0	0.497	-147	4.359	78	0.074	29	0.601	-44
		2.4	0.472	-166	3.778	66	0.077	25	0.554	-48
		3.0	0.468	170	3.120	51	0.082	21	0.495	-56
		3.5	0.466	152	2.680	39	0.086	18	0.485	-61
		4.0	0.476	137	2.333	28	0.091	15	0.476	-66
		4.5	0.491	123	2.148	18	0.096	12	0.447	-70
	5.0	0.503	109	1.963	8	0.104	11	0.423	-75	
	5.0	0.1	0.884	-13	15.377	170	0.007	83	0.982	-6
		0.5	0.753	-59	12.586	134	0.032	61	0.846	-22
		0.9	0.595	-94	9.434	111	0.046	49	0.699	-33
		1.0	0.561	-102	8.786	106	0.048	47	0.689	-34
		1.5	0.457	-134	6.309	88	0.058	39	0.596	-39
		1.9	0.421	-156	5.291	75	0.064	36	0.531	-42
		2.0	0.416	-161	5.033	72	0.065	36	0.525	-43
		2.4	0.408	-178	4.295	62	0.072	34	0.485	-47
		3.0	0.418	160	3.505	48	0.080	30	0.435	-54
3.5		0.424	143	3.012	37	0.088	26	0.426	-58	
10	0.1	0.785	-19	25.691	165	0.007	78	0.961	-8	
	0.5	0.575	-79	17.485	122	0.027	59	0.750	-28	
	0.9	0.438	-118	11.534	99	0.037	51	0.595	-35	
	1.0	0.421	-126	10.545	95	0.038	51	0.567	-35	

Table 6. Common Emitter S-Parameters (Continued)

V _{CE} (Vdc)	I _C (mA)	f (MHz)	S ₁₁		S ₂₁		S ₁₂		S ₂₂	
			S ₁₁	∠φ	S ₂₁	∠φ	S ₁₂	∠φ	S ₂₂	∠φ
		1.5	0.366	-156	7.311	80	0.050	48	0.500	-38
		1.9	0.356	-176	5.901	69	0.058	46	0.454	-39
		2.0	0.354	-180	5.625	67	0.060	46	0.449	-40
		2.4	0.362	166	4.737	57	0.069	44	0.417	-43
		3.0	0.392	148	3.842	45	0.082	38	0.372	-49
		3.5	0.399	134	3.307	35	0.092	34	0.357	-54
		4.0	0.414	120	2.907	25	0.103	29	0.345	-59
		4.5	0.434	109	2.613	16	0.113	25	0.328	-65
		5.0	0.453	98	2.374	6	0.124	18	0.307	-69
	15	0.1	0.708	-25	32.559	161	0.007	83	0.938	-10
		0.5	0.480	-94	19.200	115	0.024	58	0.679	-29
		0.9	0.381	-133	11.991	94	0.033	54	0.538	-34
		1.0	0.371	-141	10.889	90	0.035	54	0.515	-33
		1.5	0.344	-169	7.466	76	0.047	53	0.460	-36
		1.9	0.345	174	5.959	66	0.056	51	0.424	-37
		2.0	0.345	170	5.683	64	0.059	50	0.420	-38
		2.4	0.358	157	4.765	55	0.069	47	0.392	-41
		3.0	0.392	142	3.852	43	0.084	42	0.349	-47
		3.5	0.403	129	3.324	33	0.095	37	0.336	-52
		4.0	0.418	116	2.924	24	0.105	31	0.323	-57
		4.5	0.438	106	2.618	14	0.117	26	0.307	-63
	5.0	0.460	95	2.375	5	0.128	20	0.288	-67	
	20	0.1	0.639	-31	37.220	158	0.007	75	0.919	-12
		0.5	0.430	-107	19.608	110	0.022	58	0.629	-30
		0.9	0.365	-146	11.885	91	0.032	58	0.504	-32
		1.0	0.360	-153	10.741	87	0.034	58	0.483	-32
		1.5	0.350	-178	7.337	73	0.047	55	0.438	-34
1.9		0.357	167	5.815	64	0.056	54	0.408	-35	

Table 6. Common Emitter S-Parameters (Continued)

V _{CE} (Vdc)	I _C (mA)	f (MHz)	S ₁₁		S ₂₁		S ₁₂		S ₂₂		
			S ₁₁	∠φ	S ₂₁	∠φ	S ₁₂	∠φ	S ₂₂	∠φ	
		2.0	0.357	164	5.555	62	0.060	52	0.403	-36	
		2.4	0.371	152	4.641	53	0.069	49	0.378	-39	
		3.0	0.408	138	3.746	42	0.084	44	0.338	-45	
		3.5	0.419	126	3.239	32	0.096	39	0.323	-51	
		4.0	0.435	113	2.849	23	0.109	32	0.312	-56	
		4.5	0.453	104	2.545	13	0.119	27	0.295	-61	
		5.0	0.475	94	2.306	4	0.131	20	0.276	-66	
3.0	1.0	0.1	0.970	-7	3.745	175	0.007	86	0.999	-3	
		0.5	0.949	-31	3.341	154	0.034	73	0.989	-12	
		0.9	0.892	-55	3.339	136	0.059	59	0.939	-21	
		1.0	0.878	-61	3.275	132	0.065	54	0.919	-23	
		1.5	0.778	-89	2.724	112	0.084	39	0.869	-31	
		1.9	0.730	-111	2.648	96	0.093	28	0.808	-37	
		2.0	0.714	-116	2.543	93	0.095	26	0.801	-39	
		2.4	0.652	-137	2.326	80	0.098	17	0.755	-44	
		3.0	0.634	-164	2.040	61	0.098	5	0.689	-53	
		3.5	0.604	175	1.765	48	0.093	-1	0.670	-60	
	4.0	0.599	157	1.521	35	0.091	-8	0.660	-66		
	4.5	0.604	140	1.466	23	0.084	-10	0.626	-73		
	5.0	0.602	124	1.348	12	0.080	-9	0.606	-79		
	2.0	2.0	0.1	0.951	-8	6.981	173	0.007	88	0.992	-3
	0.5		0.913	-39	6.335	147	0.033	69	0.944	-14	
	0.9		0.807	-67	5.710	128	0.054	54	0.859	-25	
	1.0		0.774	-74	5.488	123	0.057	51	0.860	-27	
	1.5		0.647	-104	4.306	103	0.071	37	0.777	-35	
	1.9		0.591	-127	3.935	87	0.077	28	0.704	-40	
	2.0		0.576	-132	3.750	85	0.077	26	0.697	-42	
2.4	0.531		-152	3.316	72	0.080	22	0.647	-47		

Table 6. Common Emitter S-Parameters (Continued)

V _{CE} (Vdc)	I _C (mA)	f (MHz)	S ₁₁		S ₂₁		S ₁₂		S ₂₂	
			S ₁₁	∠ φ	S ₂₁	∠ φ	S ₁₂	∠ φ	S ₂₂	∠ φ
		3.0	0.516	-178	2.790	55	0.082	14	0.584	-55
		3.5	0.505	162	2.402	43	0.081	12	0.574	-60
		4.0	0.508	146	2.078	32	0.083	8	0.563	-65
		4.5	0.521	130	1.943	21	0.084	7	0.535	-70
		5.0	0.526	115	1.782	10	0.089	7	0.511	-76
	3.0	0.1	0.928	-9	10.077	172	0.007	84	0.991	-4
		0.5	0.859	-46	8.948	142	0.032	66	0.917	-17
		0.9	0.725	-77	7.487	121	0.049	51	0.806	-28
		1.0	0.687	-84	7.105	116	0.052	50	0.803	-30
		1.5	0.559	-115	5.356	97	0.063	38	0.711	-37
		1.9	0.505	-138	4.701	82	0.067	31	0.638	-41
		2.0	0.493	-143	4.473	79	0.068	31	0.631	-42
		2.4	0.462	-162	3.886	68	0.072	27	0.585	-47
		3.0	0.458	173	3.218	52	0.077	22	0.529	-54
		3.5	0.452	154	2.763	41	0.082	20	0.518	-59
		4.0	0.460	139	2.403	30	0.085	17	0.509	-64
		4.5	0.476	125	2.216	20	0.090	14	0.483	-69
		5.0	0.486	110	2.025	10	0.098	13	0.460	-74
	5.0	0.1	0.884	-12	15.441	170	0.007	82	0.985	-5
		0.5	0.756	-55	12.831	135	0.029	64	0.882	-22
		0.9	0.598	-90	9.722	112	0.042	50	0.743	-31
		1.0	0.570	-98	9.076	107	0.045	48	0.711	-32
		1.5	0.458	-129	6.576	89	0.054	42	0.629	-38
		1.9	0.415	-152	5.514	76	0.060	38	0.564	-40
		2.0	0.408	-157	5.251	74	0.061	37	0.557	-41
		2.4	0.395	-174	4.489	63	0.067	35	0.517	-45
		3.0	0.407	163	3.680	49	0.076	31	0.464	-51
		3.5	0.407	146	3.158	39	0.083	28	0.450	-56

Table 6. Common Emitter S-Parameters (Continued)

V _{CE} (Vdc)	I _C (mA)	f (MHz)	S ₁₁		S ₂₁		S ₁₂		S ₂₂	
			S ₁₁	∠φ	S ₂₁	∠φ	S ₁₂	∠φ	S ₂₂	∠φ
		4.0	0.417	131	2.768	29	0.090	25	0.438	-61
		4.5	0.434	118	2.517	19	0.098	21	0.419	-67
		5.0	0.450	105	2.294	9	0.108	17	0.398	-72
	10	0.1	0.795	-18	25.574	165	0.007	79	0.970	-7
		0.5	0.587	-74	17.871	123	0.025	60	0.780	-26
		0.9	0.438	-112	11.957	101	0.034	54	0.631	-33
		1.0	0.417	-119	10.950	97	0.036	52	0.602	-33
		1.5	0.351	-150	7.620	81	0.047	50	0.536	-37
		1.9	0.334	-171	6.171	70	0.054	47	0.490	-38
		2.0	0.332	-175	5.878	68	0.056	47	0.485	-39
		2.4	0.336	169	4.960	59	0.065	45	0.454	-42
		3.0	0.363	151	4.029	46	0.076	40	0.408	-48
		3.5	0.371	136	3.465	36	0.087	36	0.393	-53
		4.0	0.385	122	3.048	27	0.097	31	0.383	-58
		4.5	0.405	110	2.743	17	0.107	26	0.368	-63
		5.0	0.425	99	2.493	8	0.117	20	0.348	-68
		15	0.1	0.723	-22	32.706	163	0.006	79	0.949
	0.5		0.487	-88	19.861	116	0.021	60	0.695	-26
	0.9		0.373	-127	12.612	96	0.031	55	0.556	-32
	1.0		0.355	-134	11.492	92	0.033	55	0.555	-32
	1.5		0.317	-164	7.867	77	0.044	53	0.494	-34
	1.9		0.312	177	6.309	67	0.053	52	0.460	-37
	2.0		0.315	173	6.004	65	0.055	51	0.454	-37
	2.4		0.327	159	5.044	56	0.064	48	0.429	-41
	3.0		0.354	142	4.069	44	0.078	43	0.390	-47
	3.5		0.371	128	3.507	35	0.089	38	0.384	-52
		4.0	0.383	116	3.073	25	0.099	33	0.376	-57
	4.5	0.400	105	2.757	16	0.109	27	0.361	-61	

Table 6. Common Emitter S-Parameters (Continued)

V _{CE} (Vdc)	I _C (mA)	f (MHz)	S ₁₁		S ₂₁		S ₁₂		S ₂₂	
			S ₁₁	∠φ	S ₂₁	∠φ	S ₁₂	∠φ	S ₂₂	∠φ
20	5.0	0.427	95	2.500	7	0.120	21	0.341	-65	
	0.1	0.660	-27	37.408	160	0.006	79	0.933	-10	
	0.5	0.430	-98	20.678	112	0.021	60	0.672	-27	
	0.9	0.343	-137	12.691	93	0.030	59	0.548	-31	
	1.0	0.335	-144	11.493	89	0.032	59	0.526	-31	
	1.5	0.313	-172	7.854	75	0.044	57	0.479	-33	
	1.9	0.317	171	6.249	66	0.052	55	0.450	-34	
	2.0	0.318	168	5.963	64	0.055	54	0.446	-35	
	2.4	0.332	155	4.996	55	0.065	51	0.421	-38	
	3.0	0.365	140	4.042	43	0.080	45	0.381	-44	
	3.5	0.379	127	3.486	34	0.090	40	0.366	-50	
	4.0	0.393	115	3.068	25	0.102	34	0.356	-55	
	4.5	0.411	105	2.747	16	0.112	29	0.342	-61	
5.0	0.434	94	2.492	6	0.123	23	0.324	-66		

Table 7. Common Emitter Noise Parameters

V _{CE} (V)	I _C (mA)	freq (Ghz)	NFmin (dB)	Gamma Opt		R _n Ω	r _n Ω	G _{NF} (dB)	K
				Mag	Ang				
2.0	5.0	0.5	0.76	0.26	3	9.0	0.18	25.27	0.29
		0.7	0.76	0.25	14	8.5	0.17	23.60	0.37
		0.9	0.77	0.24	25	8.5	0.17	22.03	0.48
		1.0	0.77	0.24	31	8.0	0.16	21.29	0.51
		1.5	0.82	0.23	60	7.0	0.14	17.94	0.74
		1.9	0.90	0.22	85	6.5	0.13	15.73	0.90
		2.0	0.92	0.22	91	6.5	0.13	15.24	0.93
		2.4	1.03	0.22	116	5.5	0.11	13.54	1.03
		3.0	1.24	0.23	155	5.0	0.10	11.75	1.17
		3.5	1.47	0.25	-172	5.0	0.10	10.96	1.23
		4.0	1.74	0.27	137	6.5	0.13	10.81	1.29
3.0	3.0	0.5	0.76	0.38	8	12.0	0.24	24.32	0.22
		0.7	0.76	0.37	17	11.5	0.23	22.70	0.28
		0.9	0.76	0.37	26	11.0	0.22	21.19	0.36
		1.0	0.77	0.36	31	11.0	0.22	20.47	0.38
		1.5	0.82	0.35	56	9.5	0.19	17.24	0.59
		1.9	0.91	0.34	77	8.5	0.17	15.10	0.76
		2.0	0.94	0.34	83	8.0	0.16	14.63	0.79
		2.4	1.06	0.33	105	6.5	0.13	12.98	0.94
		3.0	1.32	0.31	141	5.0	0.10	11.27	1.12
		3.5	1.59	0.30	173	4.5	0.09	10.52	1.24
		4.0	1.92	0.29	-153	6.5	0.13	10.39	1.34

Table 8. SPICE Parameters (MBC13900 Die Parameters)

Name	Value	Name	Value	Name	Value
IS	2.77E-16	IRB	0.006	TF	6.34E-12
BF	181.6	RBM	0.047	XTF	3.051
NF	1.012	RE	4.431	VTF	1.336
VAF	40.66	RC	5.845	ITF	0.202
IKF	0.237	XTB	0.6	PTF	0
ISE	3.79E-14	EG	1.195	TR	1.02E-09
NE	2.00	XTI	0.8	FC	0.95
BR	4.547	CJE	4.52E-13		
NR	1.00	VJE	1.95		
VAR	2.722	MJE	0.58		
IKR	9.98E-04	CJC	1.56E-13		
ISC	3.78E-15	VJC	0.424		
NC	2.00	MJC	0.232		
RB	9.055	XCJC	0.187		

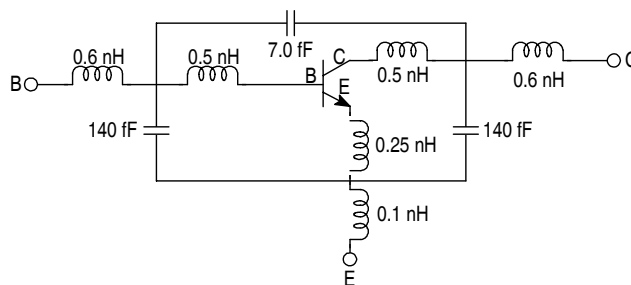
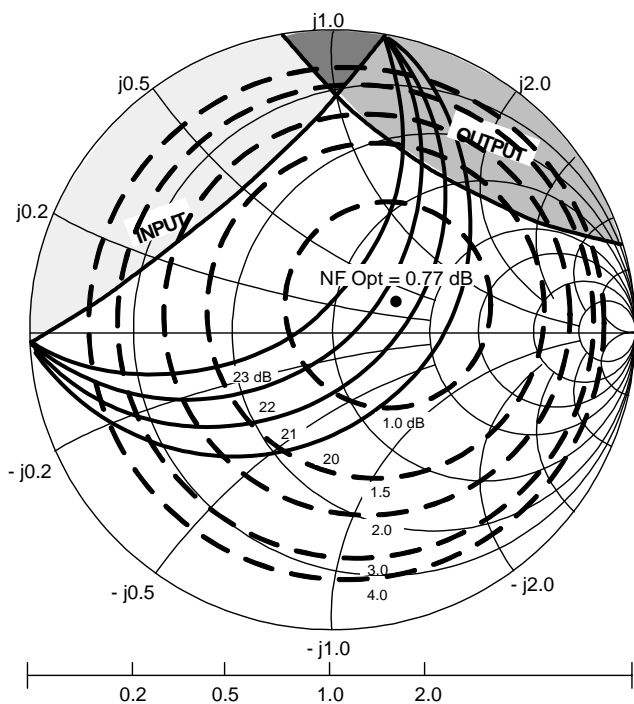

Figure 22. Simplified Package Model



$V_{CE} = 2.0\text{ V}$
 $I_C = 5.0\text{ mA}$
 ---Potentially Unstable

f (GHz)	NF Opt (dB)	Γ_O	Rn	K
0.9	0.77	$0.24 \angle 25.2^\circ$	8.5	0.48

Figure 23. Constant Gain and Noise Figure Contours (f = 900 MHz)

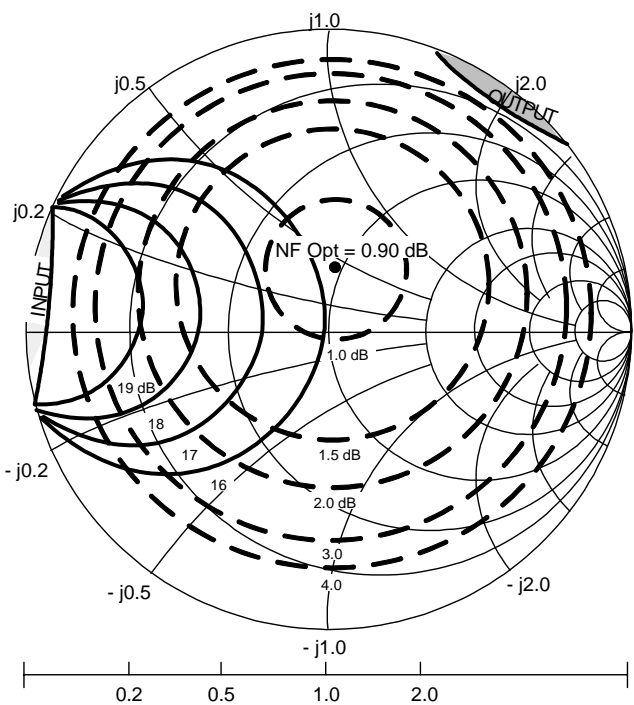

$V_{CE} = 2.0\text{ V}$
 $I_C = 5.0\text{ mA}$
 ---Potentially Unstable

f (GHz)	NF Opt (dB)	Γ_O	Rn	K
1.9	0.90	$0.22 \angle 84.5^\circ$	6.5	0.90

Figure 24. Constant Gain and Noise Figure Contours (f = 1.9 GHz)

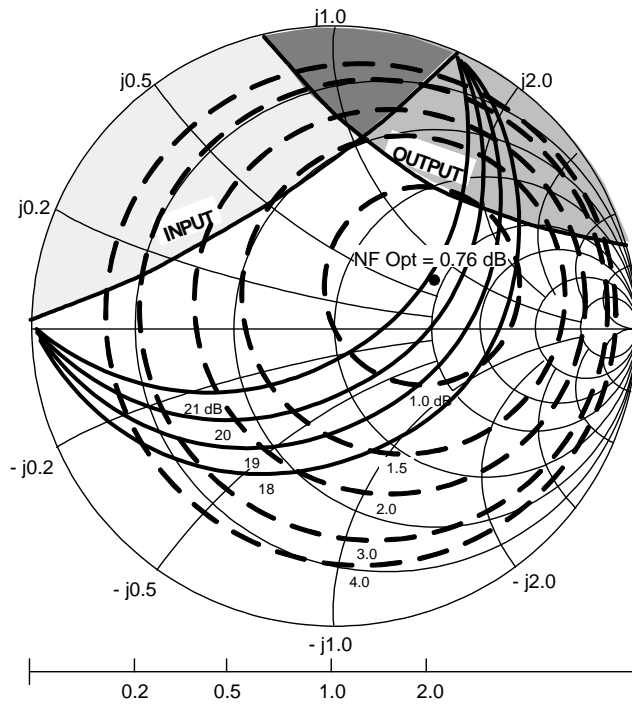

$V_{CE} = 3.0\text{ V}$
 $I_C = 3.0\text{ mA}$
 ---Potentially Unstable

f (GHz)	NF Opt (dB)	Γ_O	Rn	K
0.9	0.76	$0.37 \angle 26.3^\circ$	11	0.36

Figure 25. Constant Gain and Noise Figure Contours (f = 900 MHz)

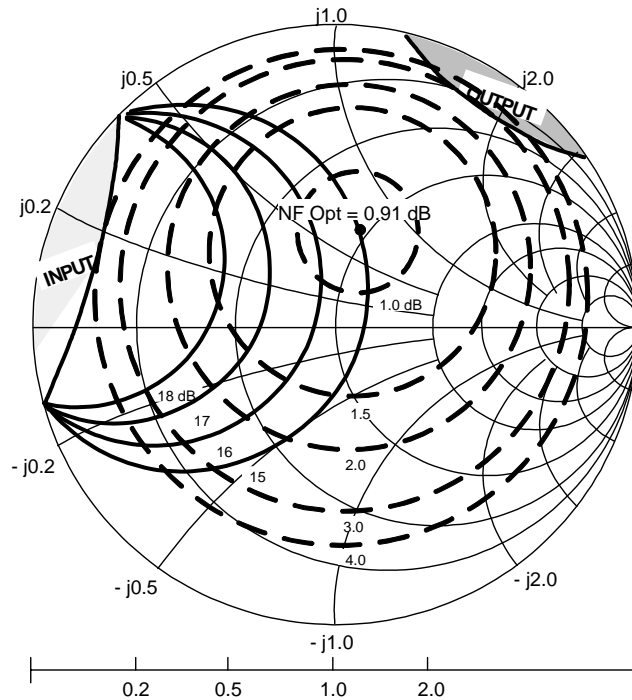

$V_{CE} = 3.0\text{ V}$
 $I_C = 3.0\text{ mA}$
 ---Potentially Unstable

f (GHz)	NF Opt (dB)	Γ_O	Rn	K
1.9	0.91	$0.34 \angle 77.2^\circ$	8.5	0.76

Figure 26. Constant Gain and Noise Figure Contours (f = 1.9 GHz)

4 Packaging

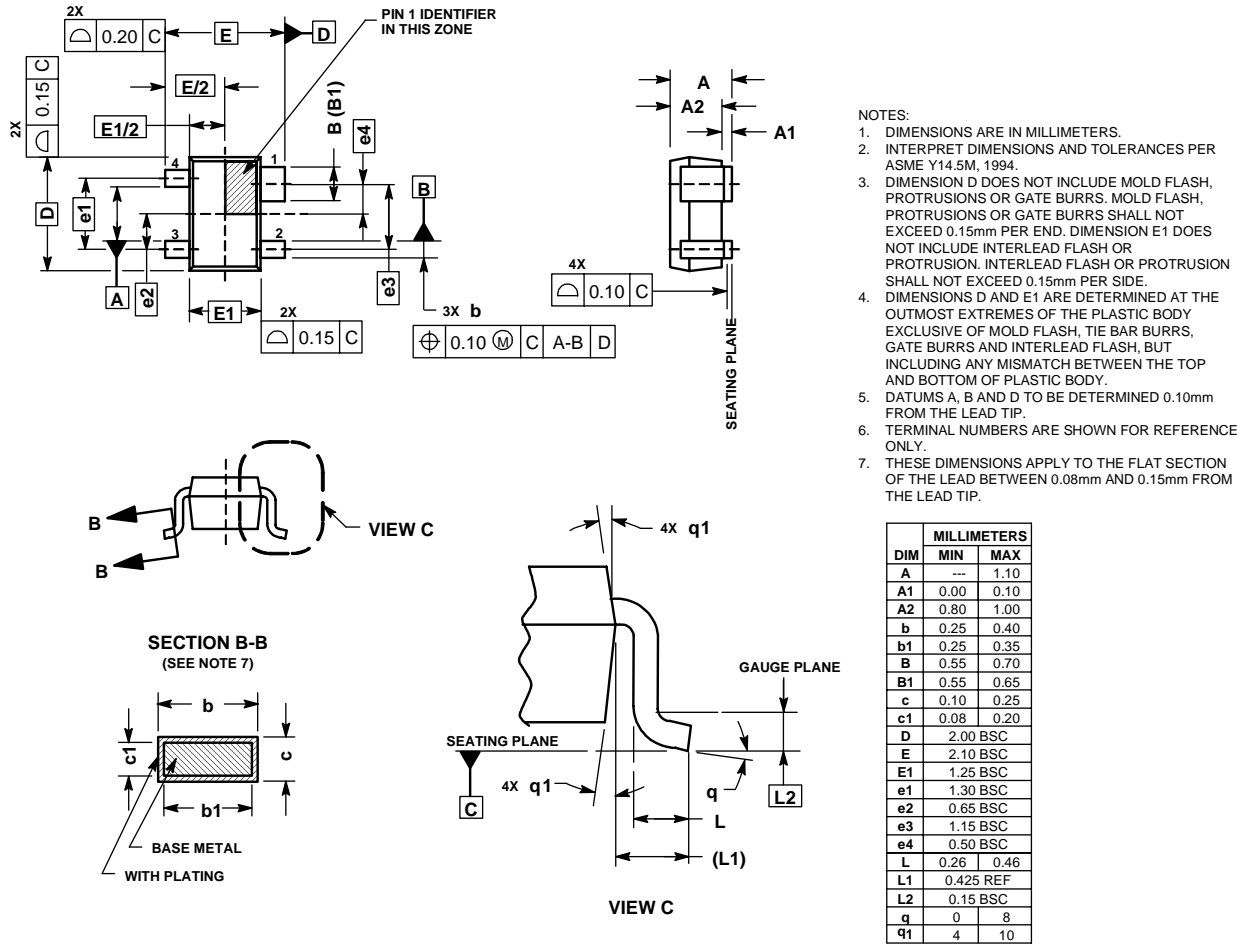

Figure 27. Outline Dimensions for SOT-343
(Case 318M-01, Issue 0)

NOTES

HOW TO REACH US:

USA/EUROPE/LOCATIONS NOT LISTED:

Motorola Literature Distribution;
P.O. Box 5405, Denver, Colorado 80217
1-303-675-2140 or 1-800-441-2447

JAPAN:

Motorola Japan Ltd.; SPS, Technical Information Center,
3-20-1, Minami-Azabu Minato-ku, Tokyo 106-8573 Japan
81-3-3440-3569

ASIA/PACIFIC:

Motorola Semiconductors H.K. Ltd.; Silicon Harbour
Centre, 2 Dai King Street, Tai Po Industrial Estate,
Tai Po, N.T., Hong Kong
852-26668334

TECHNICAL INFORMATION CENTER:

1-800-521-6274

HOME PAGE:

<http://www.motorola.com/semiconductors>

Information in this document is provided solely to enable system and software implementers to use Motorola products. There are no express or implied copyright licenses granted hereunder to design or fabricate any integrated circuits or integrated circuits based on the information in this document.

Motorola reserves the right to make changes without further notice to any products herein. Motorola makes no warranty, representation or guarantee regarding the suitability of its products for any particular purpose, nor does Motorola assume any liability arising out of the application or use of any product or circuit, and specifically disclaims any and all liability, including without limitation consequential or incidental damages. Typical parameters which may be provided in Motorola data sheets and/or specifications can and do vary in different applications and actual performance may vary over time. All operating parameters, including typicals must be validated for each customer application by customer's technical experts. Motorola does not convey any license under its patent rights nor the rights of others. Motorola products are not designed, intended, or authorized for use as components in systems intended for surgical implant into the body, or other applications intended to support or sustain life, or for any other application in which the failure of the Motorola product could create a situation where personal injury or death may occur. Should Buyer purchase or use Motorola products for any such unintended or unauthorized application, Buyer shall indemnify and hold Motorola and its officers, employees, subsidiaries, affiliates, and distributors harmless against all claims, costs, damages, and expenses, and reasonable attorney fees arising out of, directly or indirectly, any claim of personal injury or death associated with such unintended or unauthorized use, even if such claim alleges that Motorola was negligent regarding the design or manufacture of the part.



MOTOROLA

Motorola and the Stylized M Logo are registered in the U.S. Patent and Trademark Office. All other product or service names are the property of their respective owners. Motorola, Inc. is an Equal Opportunity/Affirmative Action Employer.

© Motorola, Inc. 2002

MBC13900/D

**For More Information On This Product,
Go to: www.freescale.com**