

Messerleisten

Male connectors

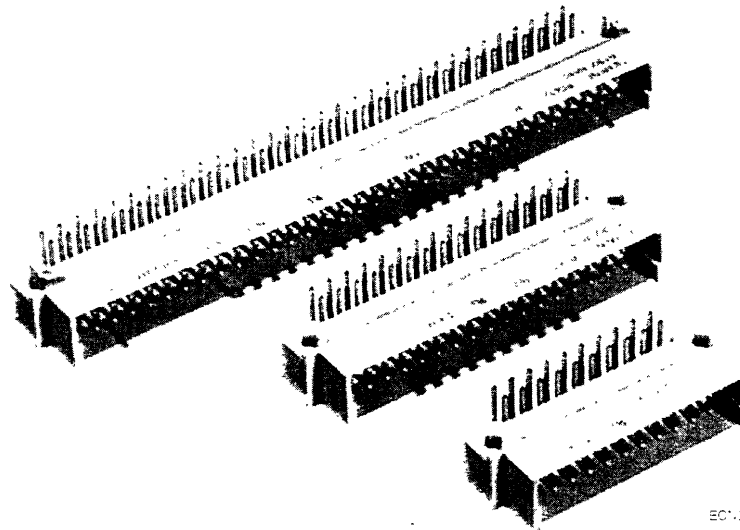

ECN 1334-L

Steckverbinder PQ 612
Connector PC 612

Schematische Darstellung nach DIN-Vorlage

Schematic depiction in accordance with DIN

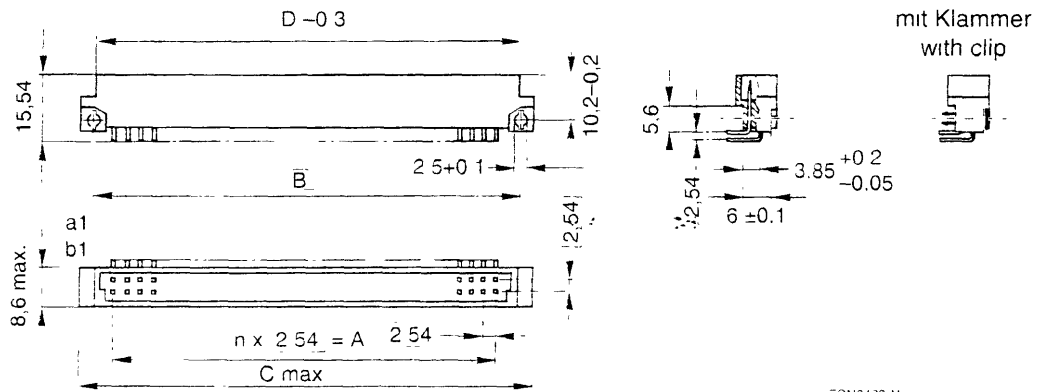

ECN 0133-N

Bauform / Type	n	A	B	C	D
B	31	78.74	88.9	94	89
B/2	15	38.1	48.26	53.36	48.36
B/3	9	22.86	33.02	38.12	33.12

Montagehinweise für Federleisten Bauform C mit 90° abgewinkelten Lötstiften und Befestigungswinkeln

Notes on installation for female connectors Type C with 90°-angled solder pins and mounting brackets

(dargestellt ist ein 96poliges Leistenpärchen im gesteckten Zustand)

(the figure shows a connector pair with 96 contacts mated)

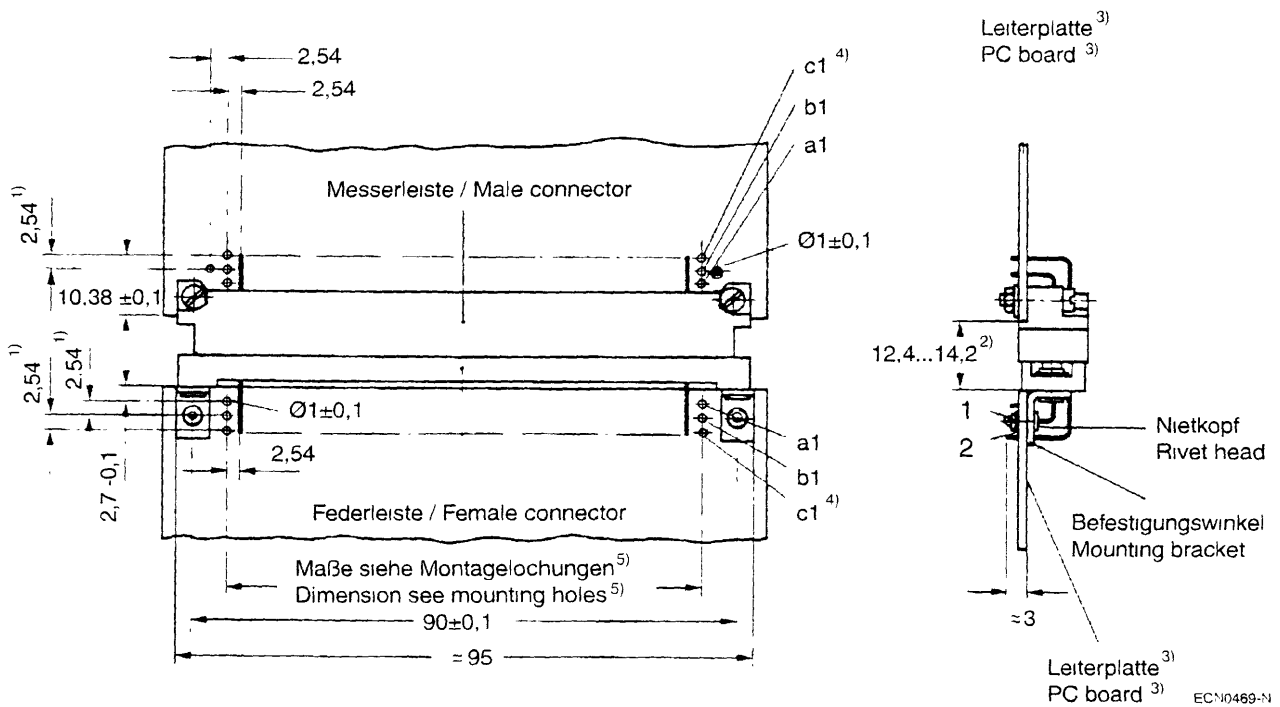

- 1) Toleranz zwischen beliebigen Teilungen ± 0,05
- 2) Erforderlich für sichere Kontaktgabe
- 3) Leiterplattenanordnung fluchtend
- 4) d h. Kontaktreihe C Kontakt 1
- 5) siehe entsprechende Leiste

- 1) Mutual pitch tolerance ± 0.05
- 2) Required for reliable contacting
- 3) PC board arranged flush
- 4) i e contact row c contact 1
- 5) corresponding connector

Folgende Befestigungsteile werden für ein Pärchen benötigt:

The following securing hardware is required for a mated pair:

- | | | |
|---|--|----------------------|
| 1 | 2 Nieten | } handels-
üblich |
| 2 | 2 Scheiben 2.2 DIN 433-A4
(Bohrung für Niet Ø 2,2 D 11) | |

- | | | |
|---|---|-----------------------------|
| 1 | 2 rivets | } Commercially
available |
| 2 | 2 washers 2.2 DIN 433-A4
(Hole for rivet Ø 2.2 D 11) | |

Montagelochung (Bauelementeseite) für gedruckte Schaltungen

Mounting holes (component side) for printed circuits

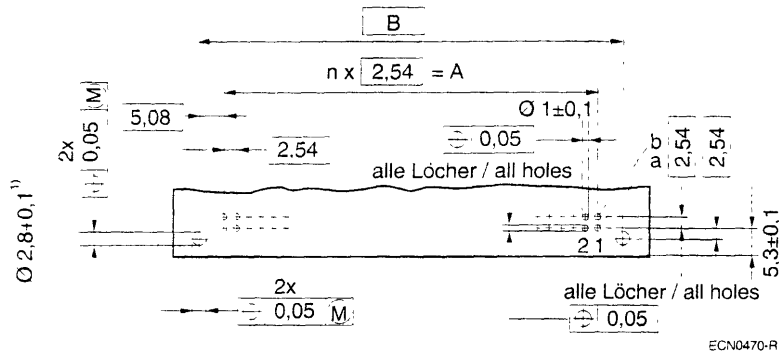

1) Befestigung siehe Seite 30

1) Mounting, see page 30

Bauform / Type	Abmessungen / Dimensions in mm				
	n	A	B	C	D
B	31	78.74	88.9	94	89
B/2	15	38.1	48.26	53.36	48.36
B/3	9	22.86	33.02	38.12	33.12

Bestellschema Messerleisten

Order code for male connectors

Datenstelle / Data position: 1 2 3 4 5 6 7 8 9 10 11 12 13 14 15
V 4 2 2 5 4 - B 1 * * * - **B 6 * ***

Anforderungsstufe / Performance level

Kontaktfläche / Contact surface	
1	I Au über Pd über Ni Au on Pd on Ni
2	II

Anford.stufe II bevorzugen / Performance level II preferred

Anschlußart / Type of connection

Maß L / Dimension L mm	
00 3 - 0.4	Lötstifte 0,6 x 0,6 mm, 90° abgewinkelt Solder pins angled at 90°
01 2,9 ± 0,3	Lotstifte 0,6 x 0,6 mm Solder pins
02 4,5 ± 0,3	
40 13 ± 0,5	Wickelstifte 0,6 x 0,6 mm Wire-wrap pins
35 5,5 ± 0,3	Lötösen Solder lugs

Bestückungsschema / Contact assignment

Polzahl / No. of contacts	
0	a v + + + ... + + + v 64 b v + + + ... + + + v
1	a v + + + ... + + + v 32 b o o o o ... o o o o
5	a o v o + ... o + o v 32 b o v o + ... o + o v

o ohne Kontakt / No contact
 + normaler Kontakt / Normal contact
 v entweder normaler Kontakt oder, bei Standardvoreilung, voreilender Kontakt / Either normal contact or, for standard pre-mating, pre-mating contact

Ausführung / Version

4	Basisausführung / Basic version
1	 mit Klammer; nur für Anschlußart 00 with clip, only for type of connection 00
3	mit Standardvoreilung / with standard pre-mating

Stackverbinder PC 612
Connectors PC 612

Lieferprogramm

Delivery program

Bestellbezeichnung / Order designation	VE Stück / Packed in units of ea.	Verpackung / Packing	Bestellbezeichnung / Order designation	VE Stück / Packed in units of ea.	Verpackung / Packing
V42254-B1100-B640	40	Blister	V42254-B1200-B635	40	Blister
V42254-B1100-B641	40		V42254-B1200-B640	40	
V42254-B1100-B645	40		V42254-B1200-B641	40	
V42254-B1102-B640	40		V42254-B1200-B645	40	
V42254-B1200-B610	40		V42254-B1202-B640	40	
V42254-B1200-B611	40		V42254-B1202-B641	40	
			V42254-B1240-B640	20	

Vorzugsteile fettgedruckt / Preferred parts in bold print

Bestellschema Messerleisten





Order code for male connectors

Datenstelle Data position	1	2	3	4	5	6	7	8	9	10	11	12	13	14	15		
	V	4	2	2	5	4	-	B	1	*	*	*	-	B	3	*	*

Anforderungsstufe / Performance level	
↓	Kontaktoberfläche / Contact surface
1	I Au über Pd über Ni
2	II Au on Pd on Ni

Anford. stufe II bevorzugen / Performance level II preferred

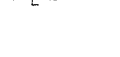
Bestückungsschema / Contact assignment											Polzahl No of contacts
1	2	3	4	..	13	14	15	16			
0	a	v	+	+	+	..	+	+	+	v	32
	b	v	+	+	+	...	+	+	+	v	
1	a	v	+	+	+	..	+	+	+	v	16
	b	o	o	o	o		o	o	o	o	
5	a	o	v	o	+		o	+	o	v	16
	b	o	v	o	+		o	+	o	v	

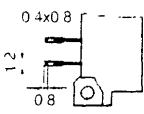
Anschlußart Type of connection	Maß L Dimension L mm
 Lotstifte 0,6 x 0,6 mm. 90° abgewinkelt Solder pins angled at 90°	00 3 - 0,4
 Lotstifte 0,6 x 0,6 mm Solder pins	01 2,9 ± 0,3 02 4,5 ± 0,3
 Wickelstifte 0,6 x 0,6 mm Wire-wrap pins	40 13 + 0,5
 Lotosen Solder lugs	35 5,5 ± 0,3
	

o ohne Kontakt / No contact
+ normaler Kontakt / Normal contact
v entweder normaler Kontakt oder, bei Standardvoreileitung, voreileitender Kontakt / Either normal contact or for standard pre-mating, pre-mating contact

Ausführung / Version	
2	Basisausführung / Basic version
1	 mit Klammer: nur für Anschlußart 00 with clip: only for type of connection 00
3	mit Standardvoreileitung / with standard pre-mating

Lieferprogramm

Delivery program

Bestellbezeichnung Order designation	VE Stück Packed in units of ea	Verpackung Packing
V42254-B1102-B320	60	Blister
V42254-B1200-B310	60	
V42254-B1200-B320	60	
V42254-B1200-B321	60	

Bestellbezeichnung Order designation	VE Stück Packed in units of ea	Verpackung Packing
V42254-B1200-B325	60	Blister
V42254-B1201-B320	60	
V42254-B1202-B320	60	
V42254-B1240-B320	30	

Vorzugsteile fettgedruckt / Preferred parts in bold print



Bestellschema Messerleisten

Order code for male connectors

Datenstelle Data position	1	2	3	4	5	6	7	8	9	10	11	12	13	14	15		
	V	4	2	2	5	4	-	B	1	*	*	*	-	B	2	*	*

Anforderungsstufe / Performance level	
↓	Kontaktfläche / Contact surface
1	I Au über Pd über Ni
2	II Au on Pd on Ni

Anford.stufe II bevorzugen / Performance level II preferred

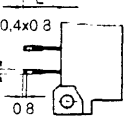
Anschlußart Type of connection	Maß L Dimension L mm
 Lötstifte 0.6 x 0.6 mm. 90° abgewinkelt Solder pins angled at 90°	00 3 - 0.4
 Lotstifte 0.6 x 0.6 mm Solder pins	01 2.9 ± 0.3 02 4.5 ± 0.3
 Wickelstifte 0.6 x 0.6 mm Wire-wrap pins	40 13 + 0.5
 Lotosen Solder lugs	35 5.5 ± 0.3

Bestückungsschema / Contact assignment	Polzahl No of contacts									
	1	2	3	4	7	8	9	10		
0 a	v	+	+	+	..	+	+	+	v	20
b	v	+	+	+		+	+	+	v	

+ normaler Kontakt / Normal contact
v entweder normaler Kontakt oder, bei Standardvoreilung, voreilender Kontakt / Either normal contact or, for standard pre-mating, pre-mating contact

Ausführung / Version	
0	Basisausführung Basic version
1	 mit Klammer; nur für Anschlußart 00 with clip, only for type of connection 00
3	mit Standardvoreilung / with standard pre-mating

Lieferprogramm

Delivery program

Bestellbezeichnung Order designation	VE Stück Packed in units of ea.	Verpackung Packing
V42254-B1100-B200	80	Blister
V42254-B1100-B230	80	
V42254-B1101-B230	80	
V42254-B1200-B200	80	
V42254-B1200-B210	80	
V42254-B1202-B200	80	

Steckverbinder PC 612
Connectors PC 612

Federleisten

Female connectors

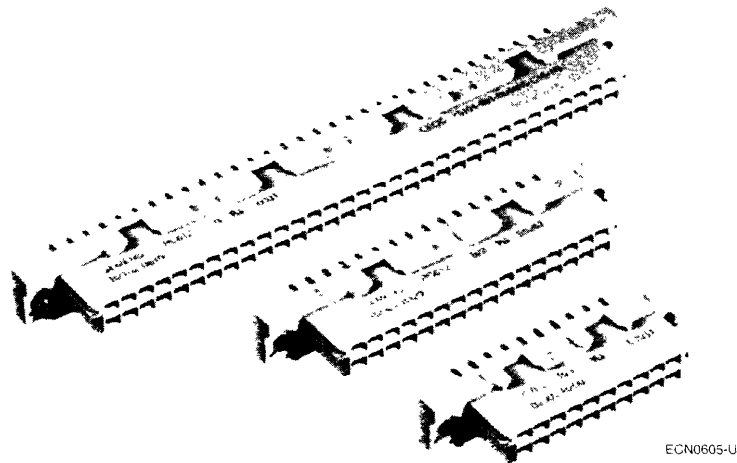

Bauform / Type	Abmessungen / Dimensions in mm						
	n	A	B	C	D	E	F
B	31	78.74	90	95	85	85	5.63
B/2	15	38.1	50	55	45	44.36	5.95
B/3	9	22,86	34.76	39,76	30	29.12	5,95

Schematische Darstellung nach DIN-Vorlage

Schematic depiction in accordance with DIN

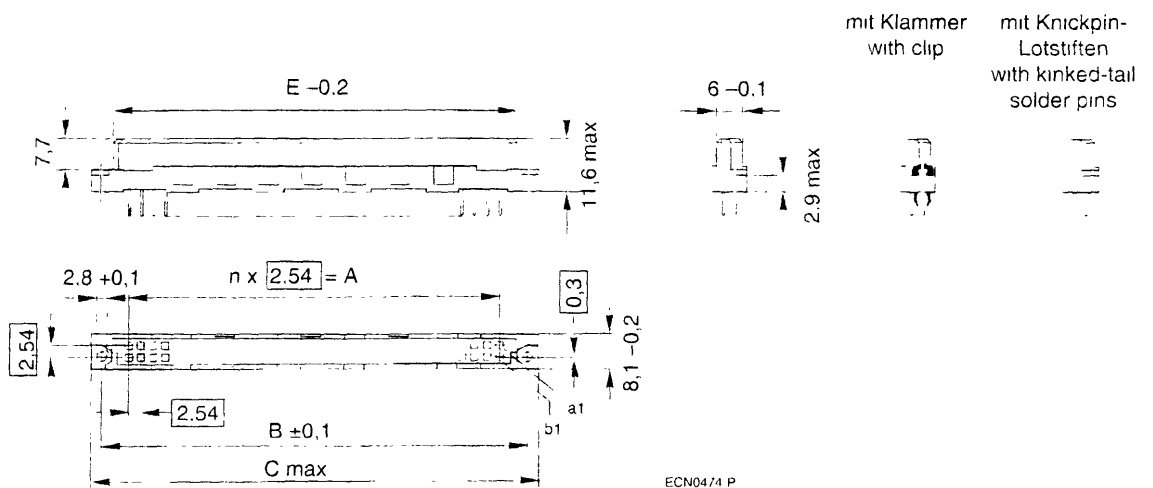

Hinweis:

Federleisten der Bauformen B, B/2 und B/3 sind auch in Schneidklemmtechnik (BK-DIN 389) lieferbar. Siehe dazu Datenbuch Steckverbinder Steckverbinder Sub-D und Schneidklemmverbinder Bestell-Nr. A23001-G21-D019-X-7400

Note:

Female connectors of the types B, B/2 and B/3 can also be supplied with IDC method of termination (BK-DIN 389). Refer to the data book on plug connectors Plug connector sub-D and insulation displacement connector order no A23001-G21-D019-X-7400

Montagelochung (Bauelementeseite) für gedruckte Schaltungen

Mounting holes (component side) for printed circuits

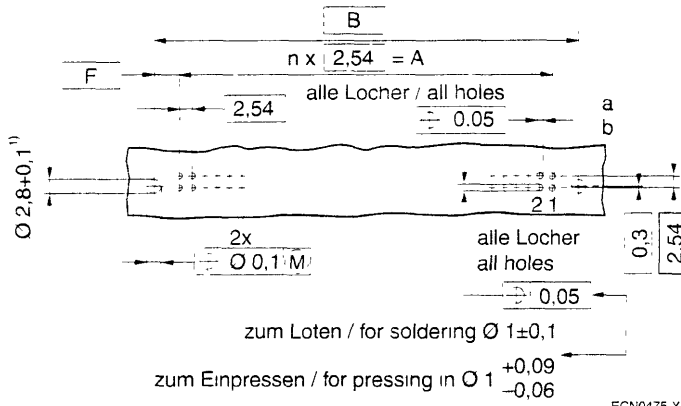

1) Befestigung siehe Seite 30

1) Mounting, see page 30

Bauform / Type	Abmessungen / Dimensions in mm						
	n	A	B	C	D	E	F
B	31	78,74	90	95	85	85	5,63
B/2	15	38,1	50	55	45	44,36	5,95
B/3	9	22,86	34,76	39,76	30	29,12	5,95

Montagelochung (Bauelementeseite) für gedruckte Schaltungen, für Leisten mit Lötstiften 90° abgewinkelt und Befestigungswinkeln

Mounting holes (component side) for printed circuits, for connectors with solder pins angled at 90° and mounting brackets

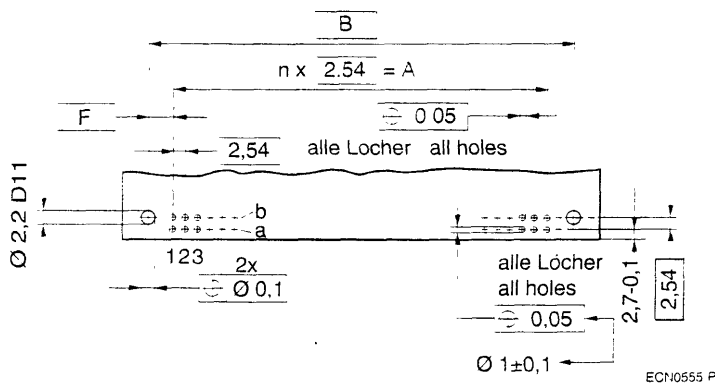

Montagehinweise siehe Seite 40

Notes on installation see page 40

Montagelochung (Bauelementeseite) für freie Verdrahtung

Mounting holes (component side) for conventional wiring

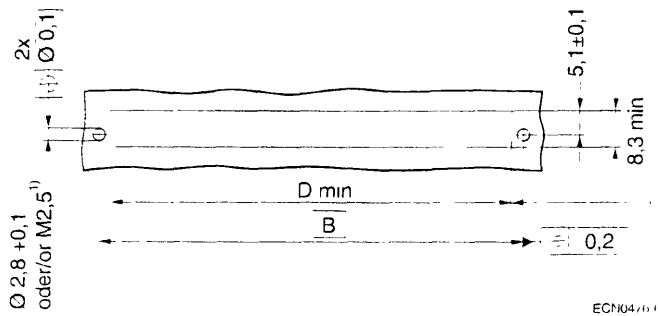

1) Befestigung siehe Seite 30

1) Mounting, see page 30

Bauform / Type	Abmessungen / Dimensions in mm						
	n	A	B	C	D	E	F
B	31	78.74	90	95	85	85	5.63
B/2	15	38.1	50	55	45	44.36	5.95
B/3	9	22.86	34.76	39.76	30	29.12	5.95

Bestellschema Federleisten in Löt- und Wickeltechnik

Order code for female connectors in solder and wrap technology

Datenstelle Data position	1	2	3	4	5	6	7	8	9	10	11	12	13	14	15		
	V	4	2	2	5	4	-	B	2	*	*	*	-	B	6	*	*

Anforderungsstufe / Performance level

Kontaktfläche / Contact surface

1	I	Au über Pd über Ni
2	II	Au on Pd on Ni

Anford.stufe II bevorzugen / Performance level II preferred

Anschlußart Type of connection	Maß L Dimension L mm
-----------------------------------	----------------------------

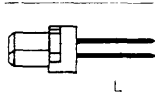
	Lötstifte 0,32 x 0,76 mm Solder pins	01	2,9 ± 0,3
		05	3,7 ± 0,3
		02	4,5 ± 0,3
		03	6,3 ± 0,3
	Lotstifte 0,6 x 0,6 mm Solder pins	04	7,3 ± 0,3

für LP-Loch $\varnothing 1 \pm 0,1$
for PCB hole \varnothing

	Wickelstifte 0,6 mm x 0,6 mm Wire-wrap pins	40	13 + 0,5
--	--	----	----------

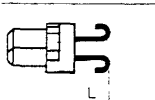
	Lothaken Solder hooks	30	5,5 ± 0,3
	Innenmaß Internal dimension 0,7 min x 2		

	Lotosen Solder lugs	35	5,5 ± 0,3

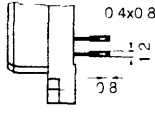
	0,4 x 0,8		
	5 24	Für Befestigung For mounting $\varnothing 2,5$	10

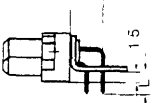
	Lotstifte 90° abgewinkelt und Befestigungswinkel Solder pins angled at 90° and mounting bracket		



Bestückungsschema / Contact assignment

Polzahl
No of contacts

		1	2	3	4	..	29	30	31	32	
0	a	+	+	+	-	..	+	-	+	+	64
	b	+	+	+	+	..	+	+	+	+	
1	a	+	+	+	+	..	+	+	+	+	32
	b	o	o	o	o	..	o	o	o	o	
5	a	o	+	o	+	..	o	+	o	+	32
	b	o	+	o	+	..	o	+	o	+	

o ohne Kontakt / No contact
+ normaler Kontakt / Normal contact

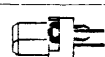
Ausführung / Version

4	Basisausführung / Basic version	
1	 mit Klammer (nicht für Anschlußart 10) with clip (not for type of connection 10)	
7	 mit Knickpin-Lotstiften, für Anschlußart 01, 02 und 05 / with kinked-tail solder pins: for type of connection 01, 02 and 05	

Lieferprogramm / Delivery program

Bestellbezeichnung Order designation	VE Stück Packed in units of ea	Verpackung Packing
V42254-B2101-B640	40	Blister
V42254-B2101-B645	40	
V42254-B2102-B640	40	
V42254-B2102-B641	40	
V42254-B2103-B640	40	
V42254-B2110-B640	15	
V42254-B2130-B641	40	
V42254-B2135-B640	40	
V42254-B2135-B641	40	
V42254-B2140-B640	20	
V42254-B2201-B610	40	
V42254-B2201-B611	40	
V42254-B2201-B640	40	
V42254-B2201-B641	40	
V42254-B2202-B640	40	
V42254-B2202-B641	40	
V42254-B2202-B645	40	
V42254-B2204-B640	40	
V42254-B2235-B640	40	
V42254-B2240-B640	20	
V42254-B2240-B641	20	

Vorzugsteile fettgedruckt / Preferred parts in bold print

Steckverbinder PC 612
Connectors PC 612

Bestellschema Federleisten in Einpreßtechnik

Order code for female connectors in press-in technology

Datenstelle
Data position

1 2 3 4 5 6 7 8 9 10 11 12 13 14 15
V 4 2 2 5 4 - P 2 * * * - B 6 4 *

Anforderungsstufe / Performance level

		Kontaktfläche / Contact surface
1	I	Au über Pd über Ni
2	II	Au on Pd on Ni

Anford.stufe II bevorzugen / Performance level II preferred

Bestückungsschema / Contact assignment

		1	2	3	4	...	29	30	31	32	Polzahl No. of contacts
0	a	+	+	-	+	...	+	+	+	+	64
	b	+	+	-	+	...	+	+	+	+	
5	a	o	+	o	+	...	o	+	o	+	32
	b	o	+	o	+	...	o	+	o	+	

o ohne Kontakt / No contact
 + normaler Kontakt / Normal contact

Anschlußart Type of connection	Maß L Dimension L mm
Einpreßanschlüsse (Lötersatz) empfohlen für LP-Dicke ab 2,2 mm Press-in terminals (Solder substitute) recommended for PCB thickness of 2.2 mm or more	63 3,7 ± 0,3
Einpreßanschlüsse (Lötersatz) empfohlen für LP-Dicke 1,4 - 2,4 mm Press-in terminals (Solder substitute) Recommended for PCB thickness of 1.4 - 2.4 mm	70 6 ± 0,3
Einpreßanschlüsse (Lötersatz) empfohlen für LP-Dicke 1,4 - 2,4 mm Press-in terminals (Solder substitute) Recommended for PCB thickness of 1.4 - 2.4 mm	77 3,7 ± 0,3
Einpreßanschlüsse mit Wickelstiften 0.6 x 0.6 mm Press-in terminals with wire-wrap pins 0.6 x 0.6 mm	60 13 + 0,5
Einpreßanschlüsse mit Wickelstiften 0.6 x 0.6 mm und Übergabesteckbereich (Anf. Stufe II) Press-in terminals with wire-wrap pins 0.6 x 0.6 mm and adapter insertion area (Perf. level II)	61 17 + 0,5
Einpreßanschlüsse mit Wickelstiften 0.6 x 0.6 mm und Übergabesteckbereich (Anf. Stufe II) Press-in terminals with wire-wrap pins 0.6 x 0.6 mm and adapter insertion area (Perf. level II)	66 13 + 0,5
Einpreßanschlüsse mit Wickelstiften 0.6 x 0.6 mm und Übergabesteckbereich (Anf. Stufe II) Press-in terminals with wire-wrap pins 0.6 x 0.6 mm and adapter insertion area (Perf. level II)	67 17 + 0,5

Lieferprogramm

Delivery program

Bestellbezeichnung Order designation	VE Stück Packed in units of ea.	Verpackung Packing
V42254-P2260-B640	20	Blister
V42254-P2261-B640	20	
V42254-P2263-B640	40	
V42254-P2263-B645	40	
V42254-P2266-B640	20	

Bestellschema Federleisten in Löt- und Wickeltechnik

Order code for female connectors in solder and wrap technology

Datenstelle
Data position

1 2 3 4 5 6 7 8 9 10 11 12 13 14 15
V 4 2 2 5 4 - **B** 2 * * * - **B** 3 * *

Anforderungsstufe / Performance level

Kontaktfläche / Contact surface

1	I	Au über Pd über Ni
2	II	Au on Pd on Ni

Anford.stufe II bevorzugen / Performance level II preferred

Bestückungsschema / Contact assignment

Polzahl
No. of contacts

		1	2	3	4	...	13	14	15	16	
0	a	+	+	+	+	...	+	+	+	+	32
	b	+	+	+	+	...	+	+	+	+	
1	a	+	+	+	+	...	+	+	+	+	16
	b	o	o	o	o	...	o	o	o	o	
5	a	o	+	o	+	...	o	+	o	+	16
	b	o	+	o	+	...	o	+	o	+	

o ohne Kontakt / No contact
+ normaler Kontakt / Normal contact

Anschlußart
Type of connection

Maß L
Dimension L
mm

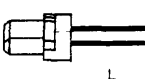
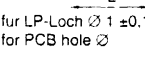
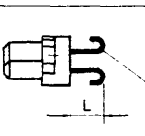
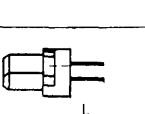
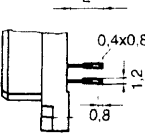
	Lötstifte 0,32 x 0,76 mm Solder pins	01	2,9 ± 0,3
	Wickelstifte 0,6 x 0,6 mm Wire-wrap pins	40	13 + 0,5
	Löthaken Solder hooks	30	5,5 ± 0,3
	Lotosen Solder lugs	35	5,5 ± 0,3
	Lotstifte 90° abgewinkelt und Befestigungswinkel Solder pins angled at 90 and mounting bracket	10	3 - 0,4

Ausführung / Version

2 Basisausführung / Basic version

1  mit Klammer (nicht für Anschlußart 10)
with clip (not for type of connection 10)

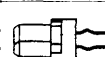
7  mit Knickpin-Lotstiften, für Anschlußart 01 und 02
with kinked-tail solder pins, for type of connection 01 and 02

Lieferprogramm / Delivery program

Bestellbezeichnung Order designation	VE Stück Packed in units of ea	Verpackung Packing
V42254-B2102-B320	60	Blister
V42254-B2201-B320	60	
V42254-B2201-B325	60	
V42254-B2202-B310	60	
V42254-B2202-B320	60	
V42254-B2202-B321	60	
V42254-B2202-B325	60	
V42254-B2210-B320	30	
V42254-B2240-B320	30	

Vorzugsteile fettgedruckt / Preferred parts in bold print

Bestellschema Federleisten in Einpreßtechnik

Order code for female connectors in press-in technology

Datenstelle Data position	1	2	3	4	5	6	7	8	9	10	11	12	13	14	15
	V	4	2	2	5	4	-	P	2	*	* *	-	B	3	2 0

Anforderungsstufe / Performance level	
↓	Kontaktfläche / Contact surface
1	I Au über Pd über Ni
2	II Au on Pd on Ni

Anford stufe II bevorzugen / Performance level II preferred

Bestückungsschema / Contact assignment								Polzahl No of contacts	
	1	2	3	4	13	14	15	16	
0 a	+	+	+	+	+	+	-	-	32
b	+	+	+	+	+	+	-	-	

o ohne Kontakt / No contact
+ normaler Kontakt / Normal contact

Anschlußart Type of connection	Maß L Dimension L mm
Einpreßanschlüsse (Lotersatz) empfohlen für LP-Dicke ab 2.2 mm Press-in terminals (Solder substitute) Recommended for PCB thickness of 2.2 mm or more	63 3.7 ± 0.3 70 6 ± 0.3
Einpreßanschlüsse (Lotersatz) empfohlen für LP-Dicke 1.4 - 2.4 mm Press-in terminals (Solder substitute) recommended for PCB thickness of 1.4 - 2.4 mm	77 3.7 ± 0.3
Einpreßanschlüsse mit Wickelstiften 0.6 x 0.6 mm Press-in terminals with wire-wrap pins 0.6 x 0.6 mm	60 13 + 0.5 61 17 + 0.5
Einpreßanschlüsse mit Wickelstiften 0.6 x 0.6 mm und Übergabesteckbereich (Anf Stufe II) Press-in terminals with wire-wrap pins 0.6 x 0.6 mm and adapter insertion area (Perf level II)	66 13 + 0.5 67 17 + 0.5

Lieferprogramm

Bestellbezeichnung Order designation
V42254-P2260-B320
V42254-P2263-B320
V42254-P2266-B320

Delivery program

VE Stück Packed in units of ea	Verpackung Packing
30	Blister
60	
30	

Bestellschema Federleisten in Löt- und Wickeltechnik

Order code for female connectors in solder and wrap technology

Datenstelle
Data position

1 2 3 4 5 6 7 8 9 10 11 12 13 14 15
V 4 2 2 5 4 - B 2 * * * - B 2 * *

Anforderungsstufe / Performance level

Kontaktfläche / Contact surface

1	I	Au über Pd über Ni Au on Pd on Ni
2	II	Au on Pd on Ni

Anford. stufe II bevorzugen / Performance level II preferred

Bestückungsschema / Contact assignment

Polzahl
No. of contacts

	1	2	3	4	7	8	9	10	
0 a	+	+	+	+		+	+	+	20
b	+	+	+	+		+	+	+	

+ normaler Kontakt / Normal contact

Ausführung / Version

0 Basisausführung / Basic version

1  mit Klammer (nicht für Anschlußart 10)
with clip (not for type of connection 10)

7  mit Knickpin-Lotstiften: für Anschlußart 01 und 02
with kinked-tail solder pins: for type of connection 01 and 02

Anschlußart
Type of connection

Maß L
Dimension L
mm

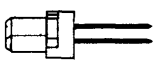

Lotstifte 0,32 x 0,76 mm
Solder pins

01	2,9 ± 0,3
02	4,5 ± 0,3

für LP-Loch $\varnothing 1 \pm 0,1$
for PCB hole $\varnothing 1$

Wickelstifte 0,6 x 0,6 mm
Wire-wrap pins

40	13 + 0,5
----	----------

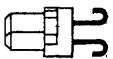

Lothaken
Solder hooks

30	5,5 ± 0,3
----	-----------

Innenmaß / Internal dimension
0,7 min. x 2

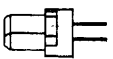

Lotosen
Solder lugs

35	5,5 ± 0,3
----	-----------

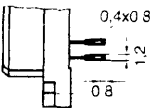

Für Befestigung / For mounting $\varnothing 2,5$ 10 3 - 0,4

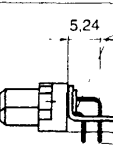

Lotstifte 90° abgewinkelt
und Befestigungswinkel
Solder pins angled at 90°
and mounting bracket

Lieferprogramm / Delivery program

Bestellbezeichnung Order designation	VE Stück Packed in units of ea	Verpackung Packing
V42254-B2101-B200	80	Blister
V42254-B2101-B210	80	
V42254-B2102-B200	80	
V42254-B2201-B200	80	
V42254-B2201-B210	80	
V42254-B2202-B200	80	
V42254-B2240-B200	40	

Steckverbinder PC 612
Connectors PC 612

Messerleisten

Male connectors

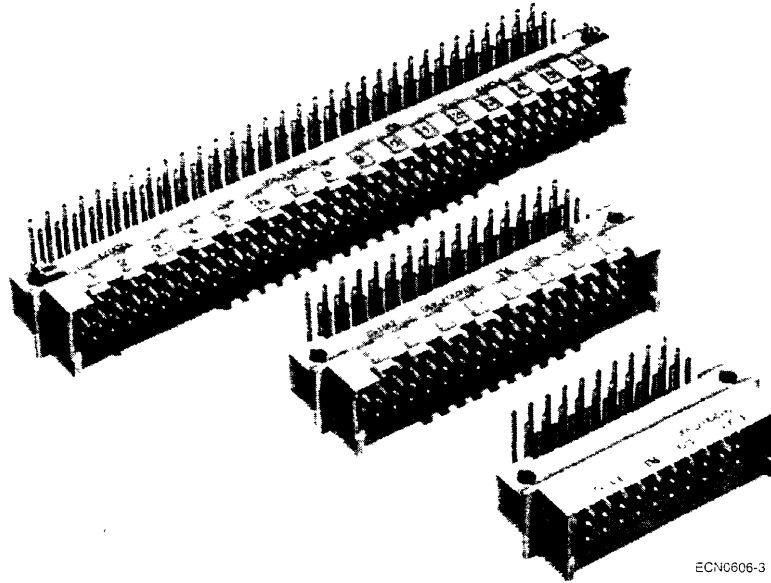

ECN6606-3

Steckverbinder PC 612
Connectors PC 612

Bauform / Type	Abmessungen / Dimensions in mm				
	n	A	B	C	D
C	31	78,74	88,9	94	89
C/2	15	38,1	48,26	53,36	48,36
C/3	9	22,86	33,02	38,12	33,12

Schematische Darstellung nach DIN-Vorlage

Schematic depiction in accordance with DIN

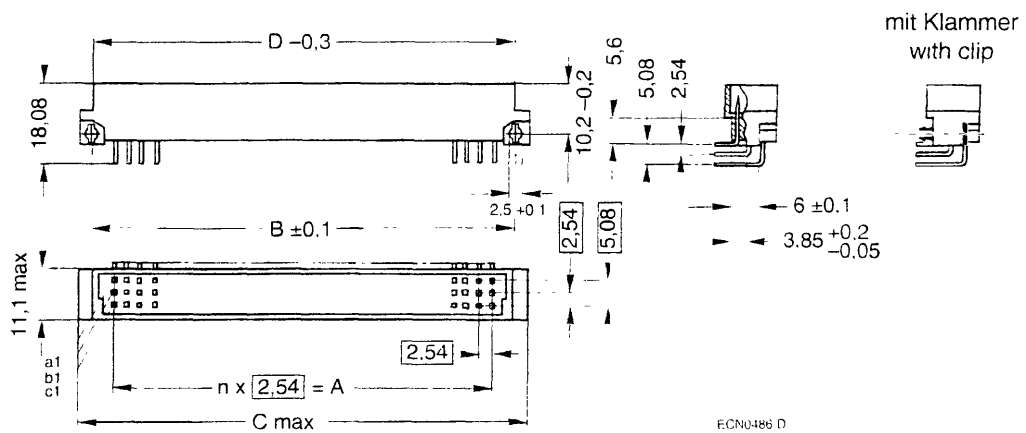

ECN0486 D