

IEC Appliance Inlet C14 with Filter



C14

 70° C

**Description**

- Panel Mount:
Screw-on mounting from front side
- 2 Functions:
Appliance Inlet Protection class I, Line-filter in standard version
- Quick connect terminals 6.3 x 0.8 mm

Approvals

- VDE License Number: 40004665
- UL License Number: E72928

Characteristics

- Compact design with optimal shielding
- All single elements are already wired
- Universal line filter for standard applications
- Qualified for use in equipment according IEC/EN 60950

References

[General Product Information](#)

Weblinks

[Approvals, RoHS, CHINA-RoHS, Mating Connectors, e-Store, Distributor-Stock-Check, Accessories](#)

Technical Data

Ratings IEC	1 - 10A @ Ta 40 °C / 250VAC; 50Hz
Ratings UL/CSA	1 - 10A @ Ta 40 °C / 125VAC; 60Hz
Leakage Current	standard < 0.5 mA (250V / 60Hz)
Dielectric Strength	> 1.7 kVDC between L-N > 2.7 kVDC between L/N-PE Test voltage (2 sec)
Impulse Withstand Voltage	> 2.5 kV between L-N (CX2) > 5 kV between L/N-PE
Allowable Operation Temp.	-25 °C to 85 °C
Climatic Category	25/085/21 acc. to IEC 60068-1
Degree of Protection	from front side IP 40 acc. to IEC 60529
Protection Class	Suitable for appliances with protection class 1 acc. to IEC 61140
Terminal	Quick connect terminals 6.3 x 0.8 mm
Panel Thickness s	Screw: max 8 mm Mounting screw torque max 0.5 Nm
Material: Housing	Thermoplastic, black, UL 94V-0

Appliance-Inlet/-Outlet	C14 acc. to IEC/EN 60320-1, UL 498, CSA C22.2 no. 42 (for cold conditions) pin-temperature 70 °C, 10A, Protection Class 1
Line Filter	Standard Version, IEC 60939, IEC 60601-1, UL 1283, UL 544, EN 133 200, CSA C22.2 no. 8 Technical details
MTBF	> 3'100'000h acc. to MIL-HB-217 F

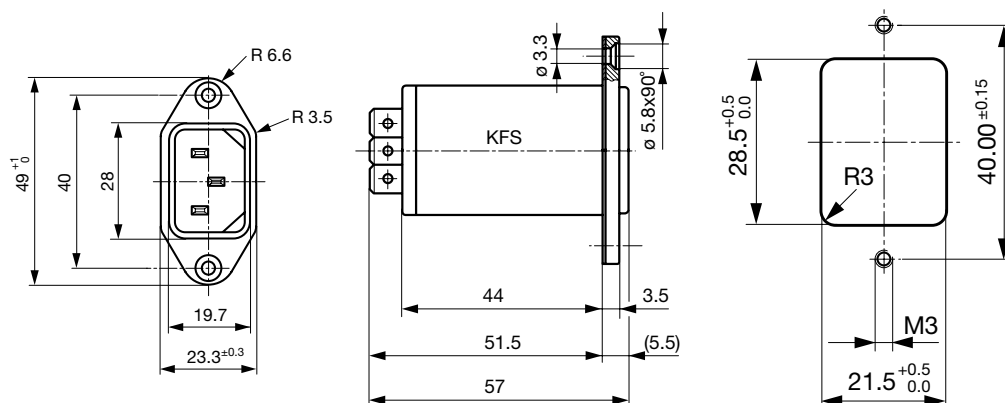
Dimensions

Technical Data of Filter-Components

Rated Current [A]	Filter-Type	Inductances L [mH]	Capacitance CX [nF]	Capacitance CY [nF]
1	Standard Version	2 x 10	47	2.2
2	Standard Version	2 x 4	47	2.2
4	Standard Version	2 x 1.5	47	2.2
6	Standard Version	2 x 0.8	47	2.2
10	Standard Version	2 x 0.3	47	2.2

Diagrams

Standard version

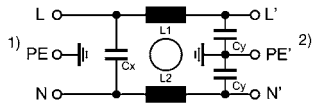

- 1) Line
- 2) Load

Attenuation Loss

--- differential mode ____ common mode

Standard version

1 A

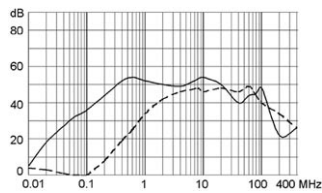

2 A

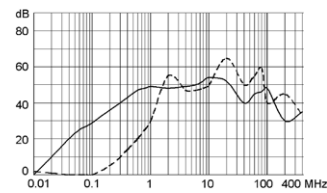

4 A

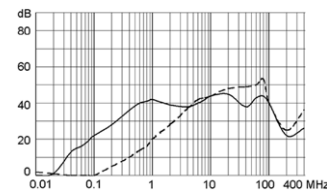

6 A

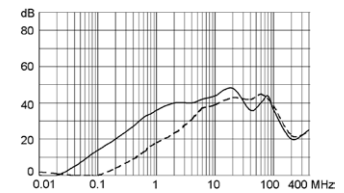

10 A

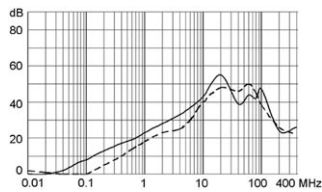

Variants

Type	Rated Current [A]	Filter-Type	CX Class	Order Number
KFS	1	Standard Version	X2	4300.5051
KFS	2	Standard Version	X2	4300.5052
KFS	4	Standard Version	X2	4300.5053
KFS	6	Standard Version	X2	4300.5054
KFS	10	Standard Version	X2	4300.5055

Packaging unit

10 Pcs

Accessories

Description

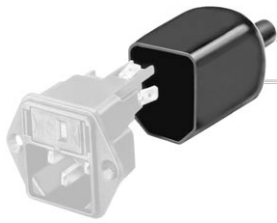

Assorted Covers
Rear Cover

0859.0048



Cord retaining kits
Cord retaining strain relief

Flat head, Z

0888.0021

Countersunk, C

4700.0003

Mating Outlets/Connectors

Category / Description

Appliance Outlet Overview complete



IEC Appliance Outlet F, Screw-on Mounting, Front Side, Solder or Quick-connect Terminal

4787

IEC Appliance Outlet F, Snap-in Mounting, Front Side, Solder or Quick-connect Terminal

4788

IEC Appliance Outlet F or H, Screw-on Mounting, Front Side, Solder, PCB or Quick-connect Terminal

5091

IEC Appliance Outlet F or H, Screw-on Mounting, Front Side, Solder or Quick-connect Terminal

5092

Appliance Outlet further types to KFS

Connector Overview complete



IEC Connector C15, Rewireable, Straight

0101

IEC Connector C15A, Rewireable, Straight

0102

IEC Connector C15A, Rewireable, Straight

0102-G

IEC Connector C15A, Rewireable, Angled

0112

IEC Connector C13, Rewireable, Angled

4012

Connector further types to KFS

...

Power Cord Overview complete



Power Cord with IEC Connector C13, Angled

0311

Power Cord with IEC Connector C13, Angled

3011

Power Cord with IEC Connector C13, Angled

3012

Power Cord with IEC Connector C13, Angled

3013

Power Cord with IEC Connector C13

3020

Power Cord further types to KFS

...