

**Features**

- High surge current capability
- Designed for a wide range of applications
- Stud cathode and stud anode version
- Leaded version available
- Types up to 1600V  $V_{RRM}$

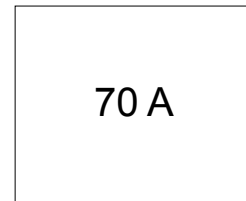

**Typical Applications**

- Battery charges
- Converters
- Power supplies
- Machine tool controls

**Major Ratings and Characteristics**

Parameters	70HF(R)		Units
	10 to 120	140 to 160	
$I_{F(AV)}$	70	70	A
@ $T_C$	140	110	°C
$I_{F(RMS)}$	110		A
$I_{FSM}$ @ 50Hz	1200		A
@ 60Hz	1250		A
$I^2t$ @ 50Hz	7100		A <sup>2</sup> s
@ 60Hz	6450		A <sup>2</sup> s
$V_{RRM}$ range	100 to 1200	1400 to 1600	V
$T_J$ range	- 65 to 180	- 65 to 150	°C



## 70HF(R) Series

Bulletin I20202 rev. E 03/04

International  
IR Rectifier

### ELECTRICAL SPECIFICATIONS

#### Voltage Ratings

Type number	Voltage Code	$V_{RRM}$ , maximum repetitive peak reverse voltage V	$V_{RSM}$ , maximum non-repetitive peak reverse voltage V	$V_{R(BR)}$ , minimum avalanche voltage V	$I_{RRM}$ max. @ $T_J = T_J$ max. mA
70HF(R)	10	100	200	200	15
	20	200	300	300	
	40	400	500	500	
	60	600	720	725	9
	80	800	960	950	
	100	1000	1200	1150	
	120	1200	1440	1350	
	140	1400	1650	1550	4.5
160	1600	1900	1750		

#### Forward Conduction

Parameter	70HF(R)		Units	Conditions	
	10 to 120	140 to 160			
$I_{F(AV)}$ Max. average forward current @ Case temperature	70	70	A	180° conduction, half sine wave	
	140	110	°C		
$I_{F(RMS)}$ Max. RMS forward current	110		A		
$I_{FSM}$ Max. peak, one-cycle forward, non-repetitive surge current	1200		A	t = 10ms	No voltage reappplied
	1250			t = 8.3ms	
	1000			t = 10ms	100% $V_{RRM}$ reappplied
	1050			t = 8.3ms	
$I^2t$ Maximum $I^2t$ for fusing	7100		A <sup>2</sup> s	t = 10ms	No voltage reappplied
	6450			t = 8.3ms	
	5000			t = 10ms	100% $V_{RRM}$ reappplied
	4550			t = 8.3ms	
$I^2/t$ Maximum $I^2/t$ for fusing	71000		A <sup>2</sup> /s	t = 0.1 to 10ms, no voltage reappplied	
$V_{F(TO)1}$ Low level value of threshold voltage	0.79		V	(16.7% $\times \pi \times I_{F(AV)} < I < \pi \times I_{F(AV)}$ ), $T_J = T_J$ max.	
$V_{F(TO)2}$ High level value of threshold voltage	1.00			(I $> \pi \times I_{F(AV)}$ ), $T_J = T_J$ max.	
$r_{f1}$ Low level value of forward slope resistance	2.33		m $\Omega$	(16.7% $\times \pi \times I_{F(AV)} < I < \pi \times I_{F(AV)}$ ), $T_J = T_J$ max.	
$r_{f2}$ High level value of forward slope resistance	1.53			(I $> \pi \times I_{F(AV)}$ ), $T_J = T_J$ max.	
$V_{FM}$ Max. forward voltage drop	1.35	1.46	V	$I_{pk} = 220A$ , $T_J = 25^\circ C$ , $t_p = 400\mu s$ rectangular wave	

Thermal and Mechanical Specifications

Parameter	70HF(R)		Units	Conditions
	10 to 120	140 to 160		
T <sub>J</sub> Max. junction operating temperature range	-65 to 180	-65 to 150	°C	
T <sub>stg</sub> Max. storage temperature range	-65 to 180	-65 to 150		
R <sub>thJC</sub> Max. thermal resistance, junction to case	0.45		K/W	DC operation
R <sub>thCS</sub> Max. thermal resistance, case to heatsink	0.25			Mounting surface, smooth, flat and greased
T Max. allowed mounting torque ±10%	2.3 - 3.4		Nm	Not lubricated threads
	20 - 30		lbf·in	
wt Approximate weight	17 (0.6)		g (oz)	
Case style	DO-203AB (DO5)			See Outline Table

$\Delta R_{thJC}$  Conduction

(The following table shows the increment of thermal resistance R<sub>thJC</sub> when devices operate at different conduction angles than DC)

Conduction angle	Sinusoidal conduction	Rectangular conduction	Units	Conditions
180°	0.08	0.06	K/W	T <sub>J</sub> = T <sub>J</sub> max.
120°	0.10	0.11		
90°	0.13	0.14		
60°	0.19	0.20		
30°	0.30	0.30		

Ordering Information Table

**Device Code**

<b>70</b>	<b>HF</b>	<b>R</b>	<b>160</b>	<b>M</b>
-----------	-----------	----------	------------	----------

(1)
(2)
(3)
(4)
(5)

- 1** - 70 = Standard device  
71 = Not isolated lead  
72 = Isolated lead with silicone sleeve  
(Red = Reverse polarity)  
(Blue = Normal polarity)
- 2** - HF = Standard diode
- 3** - None = Stud Normal Polarity (Cathode to Stud)  
R = Stud Reverse Polarity (Anode to Stud)
- 4** - Voltage code: Code x 10 = V<sub>RRM</sub> (See Voltage Ratings table)
- 5** - None = Stud base DO-203AB (DO-5) 1/4" 28UNF-2A  
M = Stud base DO-203AB (DO-5) M6 X 1

**70HF(R) Series**

Bulletin I20202 rev. E 03/04

Outlines Table

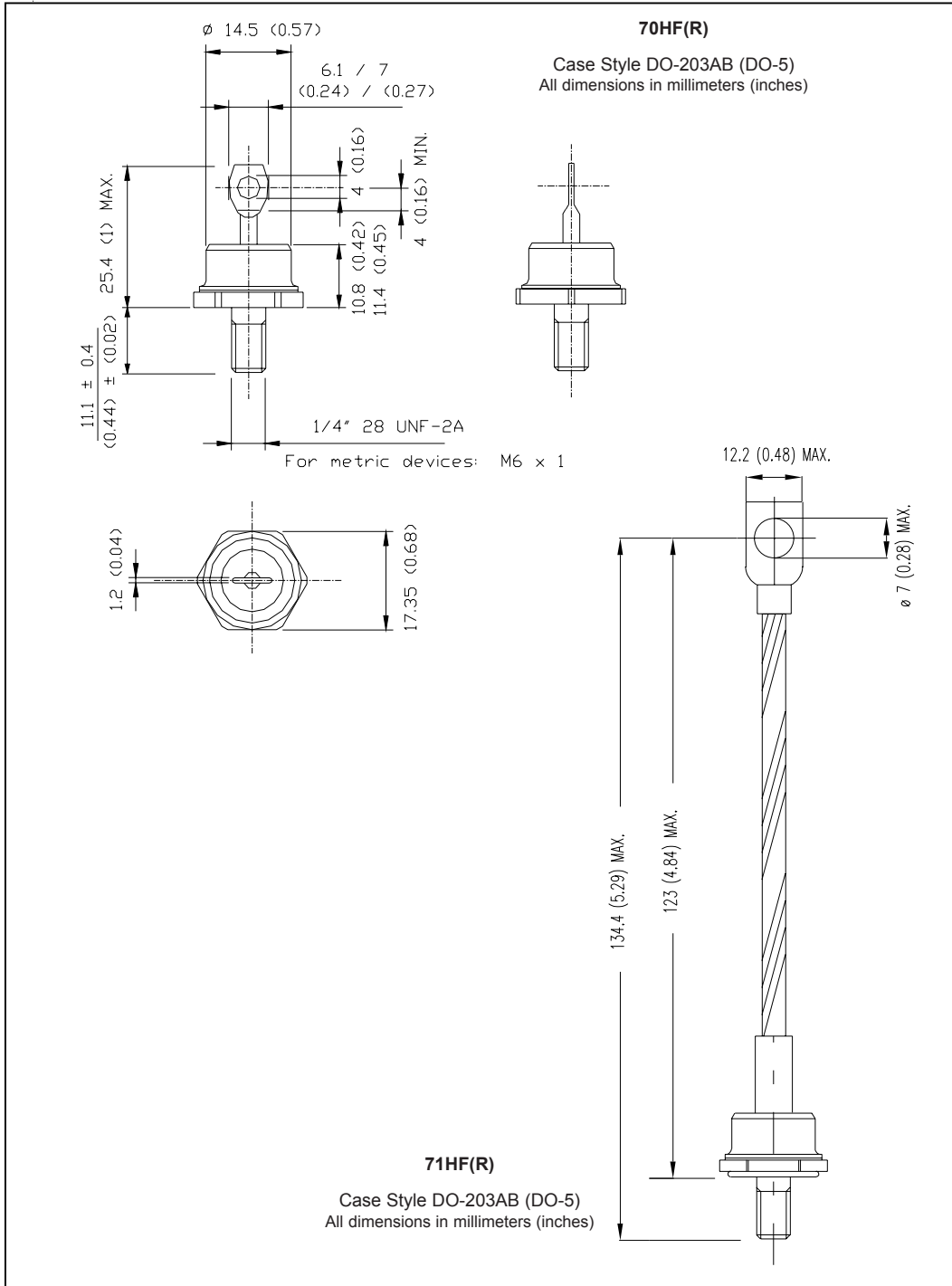



Fig. 1 - Current Ratings Characteristics



Fig. 2 - Current Ratings Characteristics

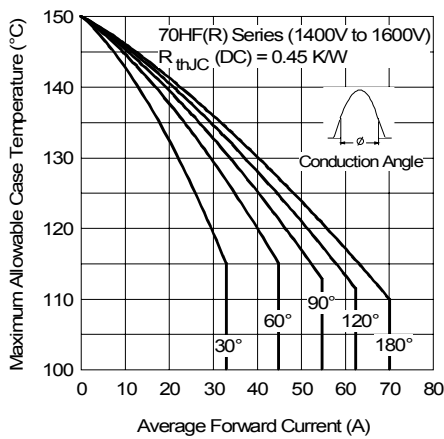

Fig. 3 - Current Ratings Characteristics

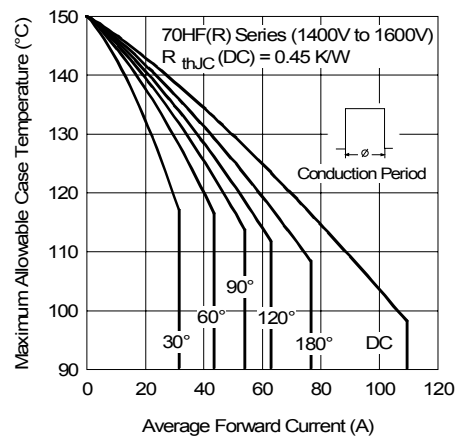

Fig. 4 - Current Ratings Characteristics



Fig. 5 - Forward Power Loss Characteristics

# 70HF(R) Series

Bulletin I20202 rev. E 03/04

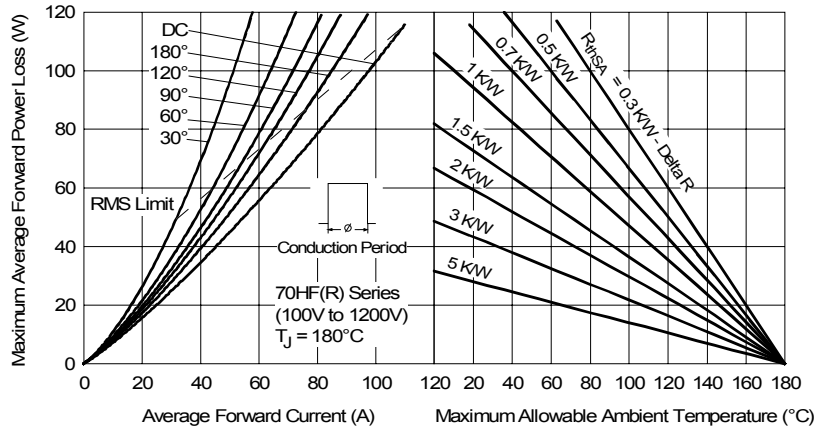

Fig. 6 - Forward Power Loss Characteristics

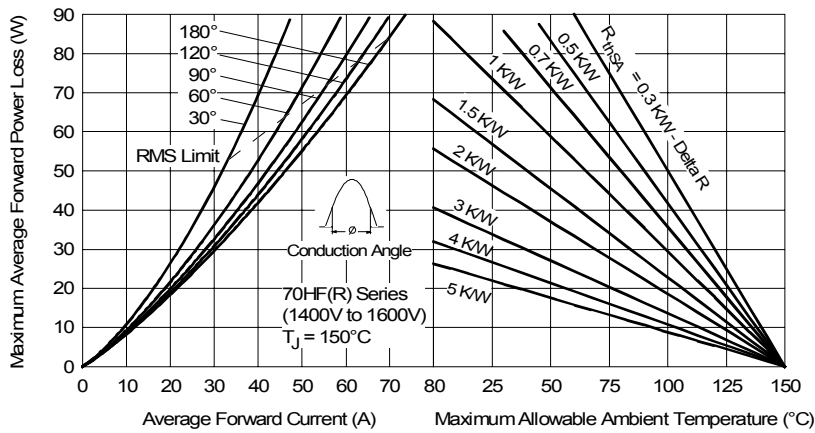

Fig. 7 - Forward Power Loss Characteristics

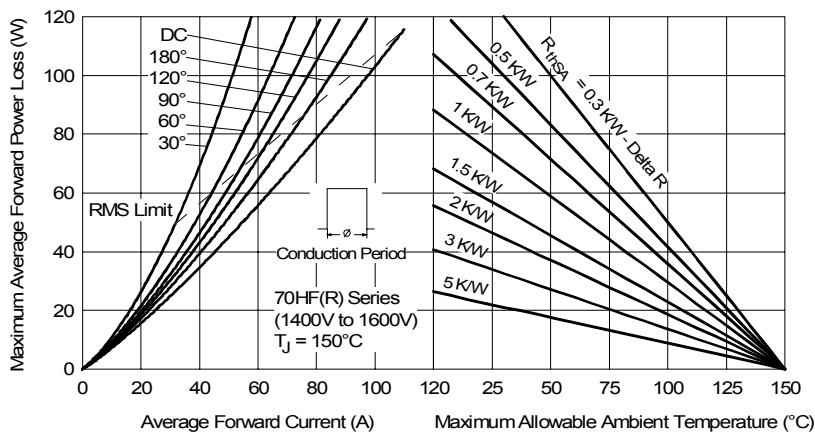

Fig. 8 - Forward Power Loss Characteristics

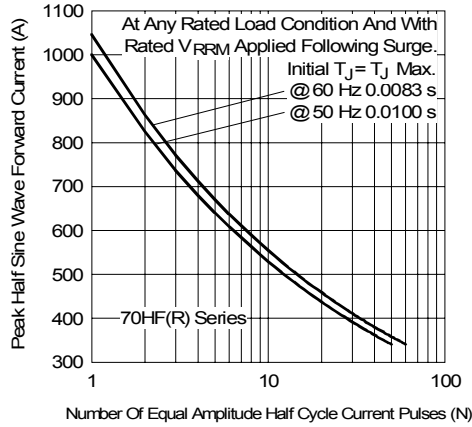

Fig. 9 - Maximum Non-Repetitive Surge Current



Fig. 10 - Maximum Non-Repetitive Surge Current

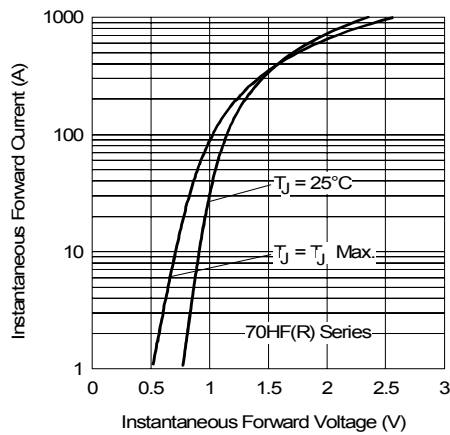

Fig. 11 - Forward Voltage Drop Characteristics

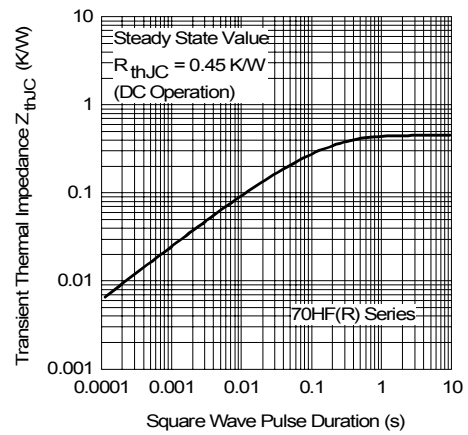

Fig. 12 - Thermal Impedance  $Z_{thJC}$  Characteristics

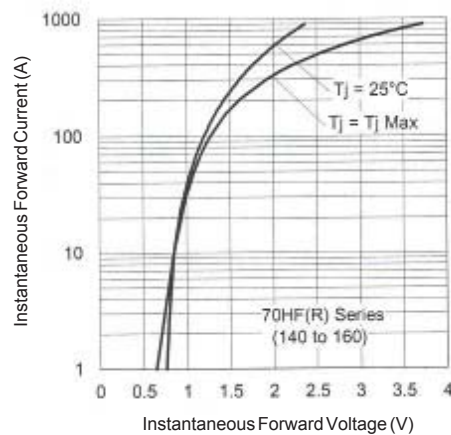

Fig. 13 - Forward Voltage Drop Characteristics

## 70HF(R) Series

Bulletin I20202 rev. E 03/04

International  
**IOR** Rectifier

---

Data and specifications subject to change without notice.  
This product has been designed and qualified for Industrial Level.  
Qualification Standards can be found on IR's Web site.

International  
**IOR** Rectifier

**IR WORLD HEADQUARTERS:** 233 Kansas St., El Segundo, California 90245, USA Tel: (310) 252-7105  
TAC Fax: (310) 252-7309  
Visit us at [www.irf.com](http://www.irf.com) for sales contact information. 03/04