

# S112S01 Series S116S01 Series

## SIP Type SSR for Medium Power Control

### ■ Features

1. Compact, high radiation resin mold package
2. RMS ON-state current  
**S112S01 Series**: 12Arms at  $T_c \leq 70^\circ\text{C}$   
 ( With heat sink)  
**S116S01 Series**: 16Arms at  $T_c \leq 60^\circ\text{C}$   
 ( With heat sink)
3. Built-in zero-cross circuit  
**(S112S02 / S212S02 / S116S02 / S216S02)**
4. High repetitive peak OFF-state voltage  
**S112S01 / S112S02 / S116S01 / S116S02**  
 $V_{\text{DRM}} : 400\text{V}$   
**S212S01 / S212S02 / S216S01 / S216S02**  
 $V_{\text{DRM}} : 600\text{V}$
5. Isolation voltage between input and output  
 $(V_{\text{iso}} : 4\,000V_{\text{rms}})$
6. Recognized by UL, file No. E94758  
**( S112S01 / S112S02 )**  
**( S116S01 / S116S02 )**
7. Approved by CSA, No. 63705  
**( S112S01 / S112S02 )**  
**( S116S01 / S116S02 )**

### ■ Applications

1. Copiers, laser beam printers
2. Automatic vending machines
3. FA equipment

### ■ Model line-ups

	For 100V lines	For 200V lines
For phase control No built-in zero-cross circuit	<b>S112S01</b>	<b>S212S01</b>
	<b>S116S01</b>	<b>S216S01</b>
Built-in zero-cross circuit	<b>S112S02</b>	<b>S212S02</b>
	<b>S116S02</b>	<b>S216S02</b>

### ■ Outline Dimensions

(Unit : mm)

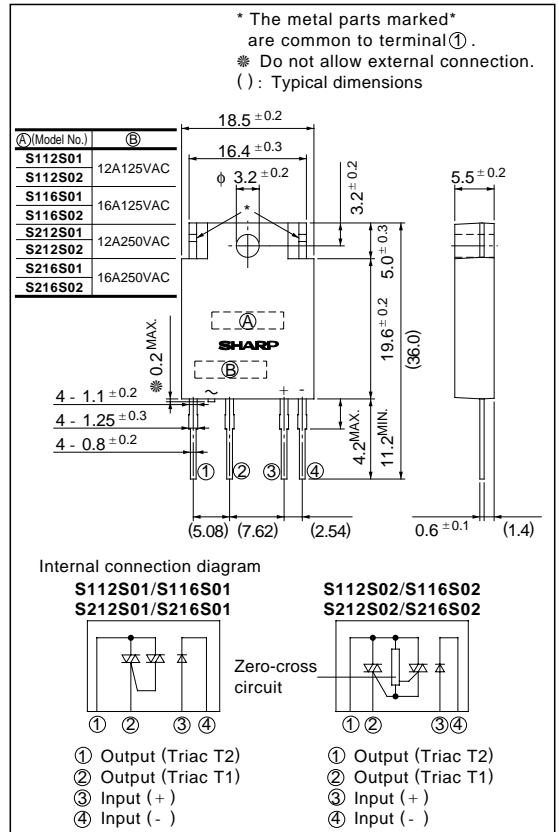

## Absolute Maximum Ratings

(Ta = 25°C)

Parameter		Symbol	Rating	Unit	
Input	Forward current	I <sub>F</sub>	50	mA	
	Reverse voltage	V <sub>R</sub>	6	V	
Output	RMS ON-state current	I <sub>T</sub>	<sup>*4</sup> 12	A <sub>rms</sub>	*1 AC 60Hz sine wave, T <sub>j</sub> = 25°C start *2 AC 60Hz for 1 minute, 40 to 60 % RH. Apply voltages between input and output by the dielectric withstand voltage tester with zero-cross circuit. (Input and output shall be shorted respectively) . (Note) When the isolation voltage is necessary at using external heat sink, please use the insulation sheet. *3 For 10 seconds *4 T <sub>C</sub> <= 70°C *5 T <sub>C</sub> <= 60°C
			<sup>*5</sup> 16	A <sub>rms</sub>	
	*1 Peak one cycle surge current	I <sub>surge</sub>	120	A	
			160	A	
	Repetitive peak OFF-state voltage	V <sub>DRM</sub>	400	V	
			600	V	
			400	V	
	Non-repetitive peak OFF-state voltage	V <sub>DSM</sub>	600	V	
400			V		
Critical rate of rise of ON-state current		dI/dt	50	A/μs	
Operating frequency		f	45 to 65	Hz	
*2 Isolation voltage		V <sub>iso</sub>	4 000	V <sub>rms</sub>	
Operating temperature		T <sub>opr</sub>	- 25 to + 100	°C	
Storage temperature		T <sub>stg</sub>	- 30 to + 125	°C	
*3 Soldering temperature		T <sub>sol</sub>	260	°C	

## Electrical Characteristics

(Ta = 25°C)

Parameter		Symbol	Conditions	MIN.	TYP.	MAX.	Unit	
Input	Forward voltage	V <sub>F</sub>	I <sub>F</sub> = 20mA	-	1.2	1.4	V	
	Reverse current	I <sub>R</sub>	V <sub>R</sub> = 3V	-	-	10 <sup>-4</sup>	A	
Output	Repetitive peak OFF-state current		I <sub>DRM</sub>	V <sub>D</sub> = V <sub>DRM</sub>	-	-	10 <sup>-4</sup>	A
	ON-state voltage	S112S01 Series	V <sub>T</sub>	Resistance load I <sub>F</sub> = 20mA, I <sub>T</sub> = 12Arms	-	-	1.5	V <sub>rms</sub>
		S116S01 Series		Resistance load I <sub>F</sub> = 20mA, I <sub>T</sub> = 16Arms	-	-	1.5	V <sub>rms</sub>
	Holding current		I <sub>H</sub>	-	-	-	50	mA
	Critical rate of rise of OFF-state voltage		dV/dt	V <sub>D</sub> = 2/3 • V <sub>DRM</sub>	30	-	-	V/μs
	Critical rate of rise of commutating OFF-state voltage		(dV/dt) <sub>C</sub>	T <sub>j</sub> = 125°C, V <sub>D</sub> = 400V, *6	5	-	-	V/μs
	Zero-cross voltage	S112S02 / S212S02 S116S02 / S216S02	V <sub>OX</sub>	I <sub>F</sub> = 8mA	-	-	35	V
Transfer characteristics	Minimum trigger current	S112S01 / S212S01 S116S01 / S216S01 S112S02 / S212S02 S116S02 / S216S02	I <sub>FT</sub>	V <sub>D</sub> = 12V, R <sub>L</sub> = 30Ω	-	-	8	mA
				V <sub>D</sub> = 6V, R <sub>L</sub> = 30Ω	-	-	8	mA
	Isolation resistance		R <sub>ISO</sub>	DC500V, RH = 40 to 60 %	10 <sup>10</sup>	-	-	Ω
	Turn-on time	S112S01 / S212S01 S116S01 / S216S01 S112S02 / S212S02 S116S02 / S216S02	t <sub>on</sub>	AC 50Hz	-	-	1	ms
-					-	10	ms	
Turn-off time		t <sub>off</sub>	AC 50Hz	-	-	10	ms	
Thermal resistance (Between junction and case)		S112S01 series S116S01 series	R <sub>th(j-c)</sub>	-	-	3.8	°C/W	
				-	-	3.3	°C/W	
Thermal resistance (Between junction and ambience)		R <sub>th(j-a)</sub>	-	-	-	40	°C/W	

\*6 S112S01 Series: dI<sub>T</sub>/dt = -6A/msS116S01 Series: dI<sub>T</sub>/dt = -8A/ms

**Fig. 1 RMS ON-state Current vs. Ambient Temperature (S112S01Series)**

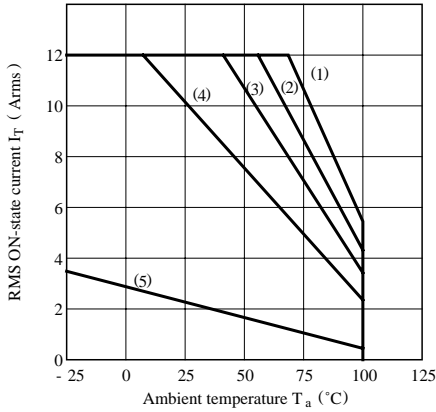

- (1) With infinite heat sink
- (2) With heat sink (280 x 280 x 2 mm Al plate)
- (3) With heat sink (200 x 200 x 2 mm Al plate)
- (4) With heat sink (100 x 100 x 2 mm Al plate)
- (5) Without heat sink

**Fig. 2 RMS ON-state Current vs. Ambient Temperature (S116S01Series)**

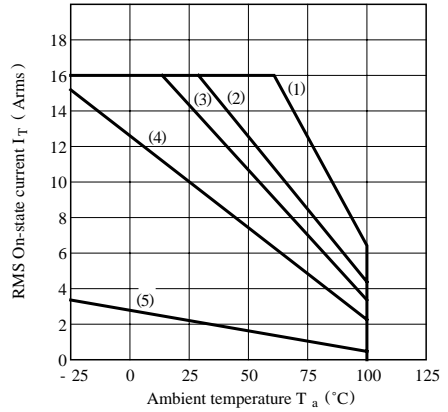

- (1) With infinite heat sink
- (2) With heat sink (280 x 280 x 2 mm Al plate)
- (3) With heat sink (200 x 200 x 2 mm Al plate)
- (4) With heat sink (100 x 100 x 2 mm Al plate)
- (5) Without heat sink

(Note) With the Al heat sink set up vertically, tighten the device at the center of the Al heat sink with a torque of 0.4N · m and apply thermal conductive silicone grease on the heat sink mounting plate. Forcible cooling shall not be carried out.

**Fig. 3 RMS ON-state Current vs. Case Temperature**

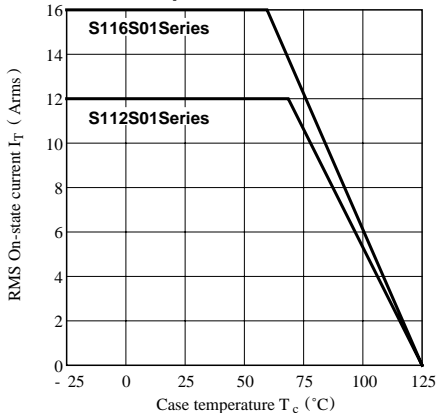

**Fig. 4 Forward Current vs. Ambient Temperature**

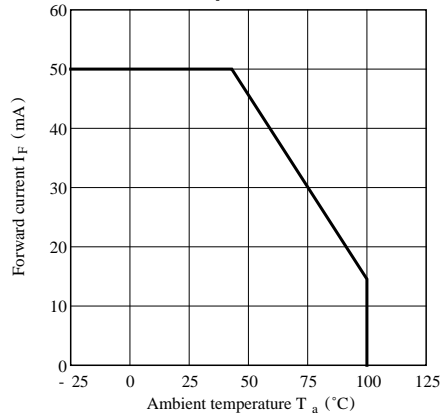

**Fig. 5 Forward Current vs. Forward Voltage**

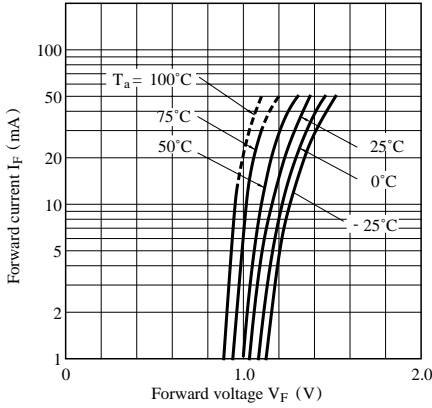

**Fig. 6 Surge Current vs. Power-on Cycle**

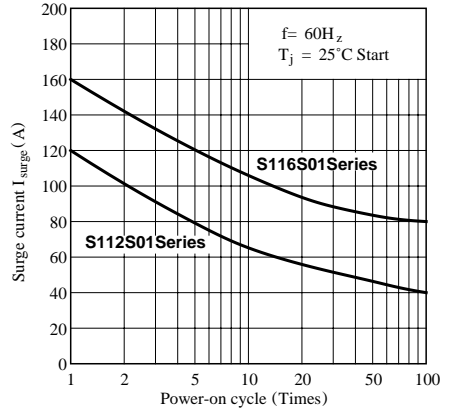

**Fig. 7 Maximum ON-state Power Dissipation vs. RMS ON-state Current (S112S01Series)**

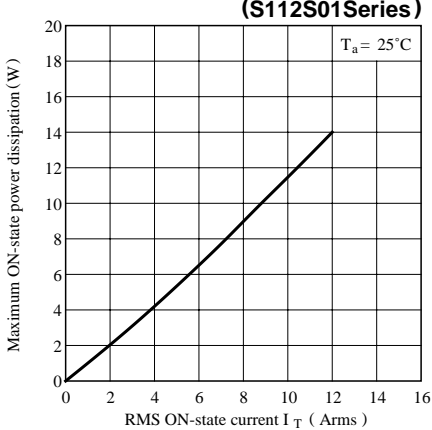

**Fig. 8 Maximum ON-state Power Dissipation vs. RMS ON-state Current (S116S01Series)**

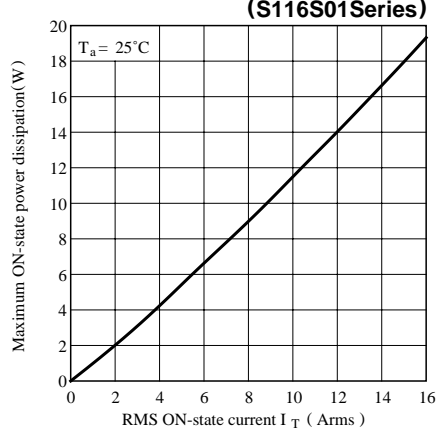

**Fig. 9 Minimum Trigger Current vs. Ambient Temperature**

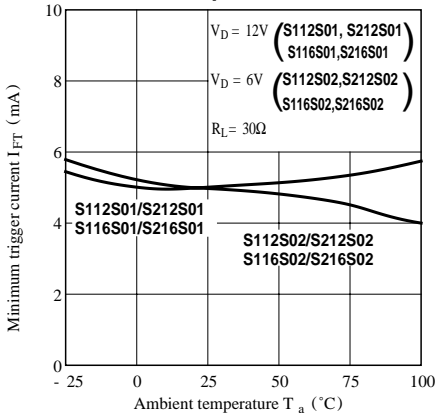

**Fig.10 Repetitive Peak OFF-state Current vs. Ambient Temperature (S112S01/S112S02/S116S01/S116S02)**

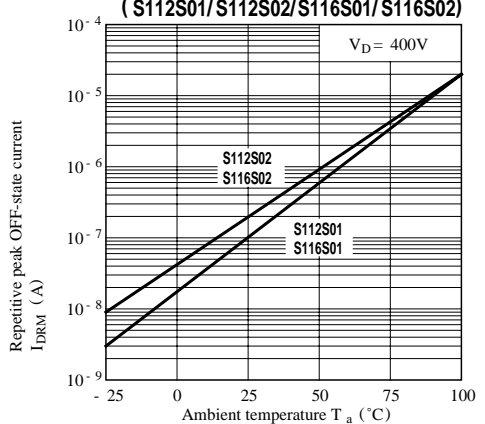
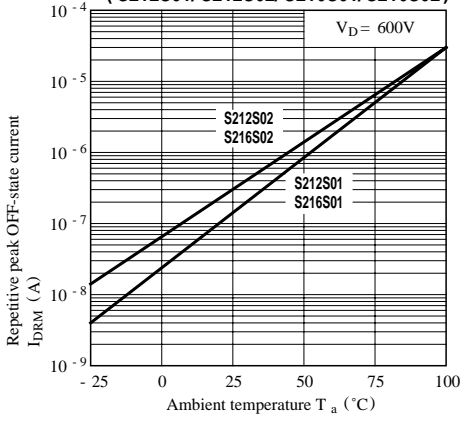

Fig.11 Repetitive Peak OFF-state Current vs. Ambient Temperature  
( S212S01/S212S02/S216S01/S216S02 )



● Please refer to the chapter “Precautions for Use.”