

Customer Information Sheet

DRAWING No.: M80-4C10605F1-04-325-00-000

SHEET 2 OF 2

IF IN DOUBT - ASK

©

NOT TO SCALE

THIRD ANGLE PROJECTION

ALL DIMENSIONS IN mm

SPECIFICATIONS:

MATERIAL:

MOULDING: GLASS FILLED PPS, UL94V-0, BLACK

SIGNAL CONTACT:

CLIP = BERYLLIUM COPPER

SHELL = BRASS

POWER CONTACT:

BODY = BRASS

LATCHING COLLAR = BERYLLIUM COPPER

JACKSCREW, CIRCLIP: STAINLESS STEEL

FINISH:

SIGNAL CONTACT:

CLIP = 0.3µ GOLD

SHELL = 0.25-0.3µ GOLD

POWER CONTACT:

BODY = GOLD

LATCHING COLLAR = NICKEL

ELECTRICAL:

WORKING VOLTAGE = 120V AC/DC

VOLTAGE PROOF = 360V AC/DC

INSULATION RESISTANCE = 100MΩ MIN

SIGNAL CONTACT:

CURRENT RATING AT 25°C = 3.0A MAX

CURRENT RATING AT 85°C = 2.2A MAX

CONTACT RESISTANCE = 25 mΩ MAX

POWER CONTACT:

CONTACT RESISTANCE = 6 mΩ MAX

CURRENT RATING = 20A MAX WITH 12AWG
CONTACT AS SPECIFIED

MECHANICAL:

DURABILITY = 500 OPERATIONS

SIGNAL CONTACT:

INSERTION FORCE = 2.8N MAX

WITHDRAWAL FORCE = 0.2N MIN

POWER CONTACT:

INSERTION FORCE = 5N MAX

WITHDRAWAL FORCE = 0.5N MIN

ENVIRONMENTAL:

TEMPERATURE RANGE = -55°C TO +125°C

PACKING:

BAG

FOR COMPLETE SPECIFICATION SEE COMPONENT SPECIFICATION C005XX (LATEST ISSUE)

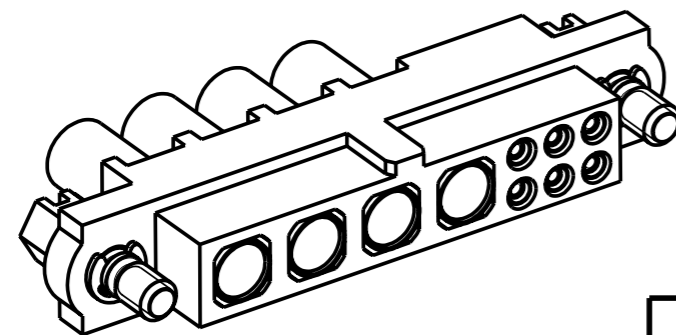
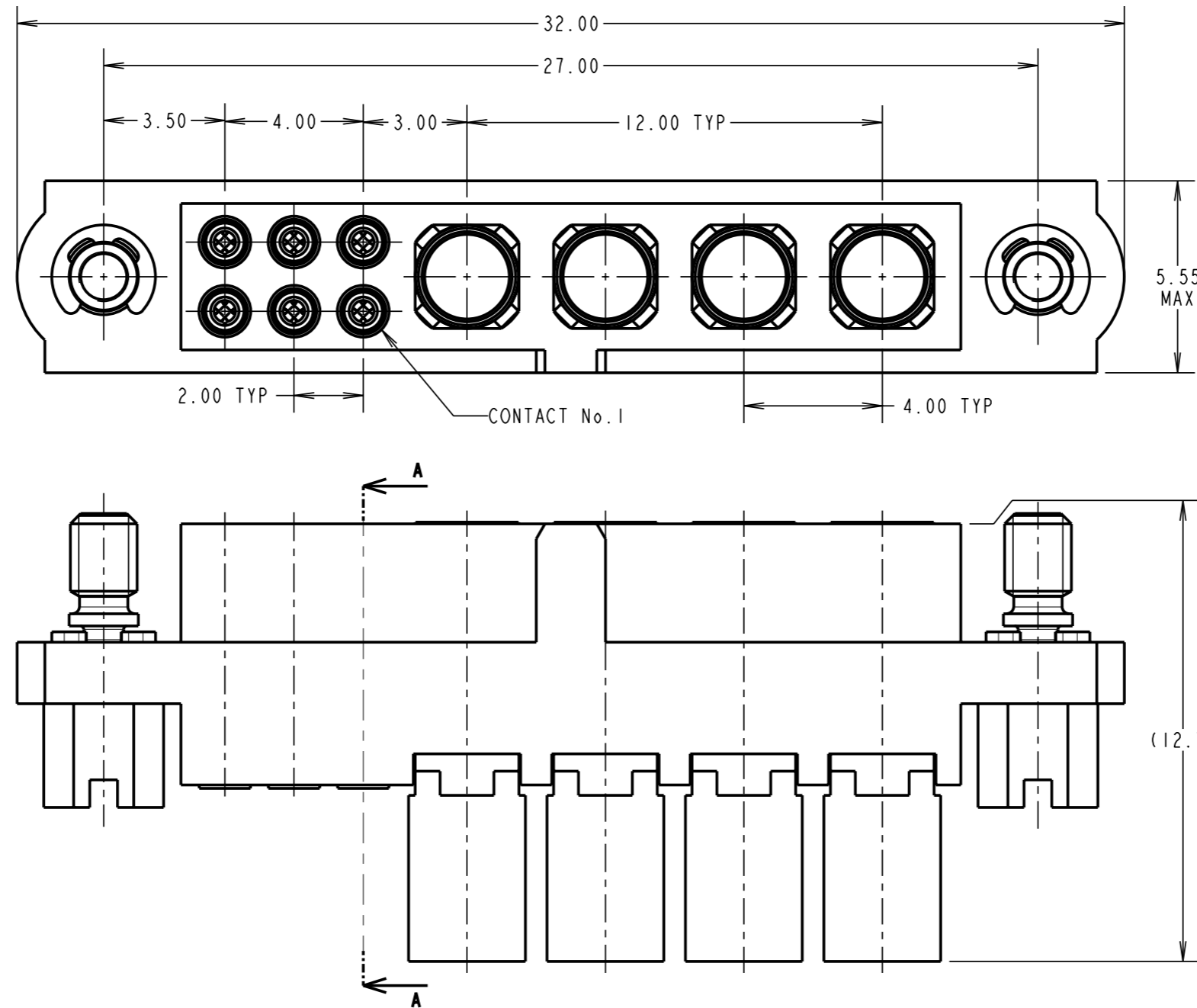

NOTES:

- CONNECTORS ARE SUPPLIED WITH CONTACTS LOOSE.
- FOR EXTRA SIGNAL CONTACTS, USE PART NUMBER M80-0130005.
- RECOMMENDED SIGNAL WIRE TYPE = BS 3G 210 TYPE A, PTFE INSULATED 24-28 AWG. MAX INSULATION DIAMETER = Ø1.10mm. STRIP WIRE BY 2.00MM FOR CRIMPING.
- RECOMMENDED HAND CRIMP TOOL FOR SIGNAL CONTACTS = M22520/2-01 WITH POSITIONER T5747.
- SIGNAL CONTACT INSERTION AND EXTRACTION TOOL = Z80-280.
- FOR EXTRA POWER CONTACTS, USE PART NUMBER M80-325
- POWER CONTACT WIRE, STRIP BY 5.00mm MINIMUM
- POWER CONTACT EXTRACTION TOOL = Z80-290
- INSTRUCTION SHEETS ARE AVAILABLE.

RA	A	03.03.08	----
NAME	ISS.	DATE	C/NOTE
APPROVED:		R.ADDE	
CHECKED:		M.G.PLESTED	
DRAWN:		R.ADDE	
CUSTOMER REF.:			
ASSEMBLY DRG:			

HARWIN

HARWIN USA
TEL: 603 893 5376
FAX: 603 893 5396
mis@harwin.com

HARWIN Europe (UK)
TEL: 023 9231 4545
FAX: 023 9231 4590
mis@harwin.co.uk

HARWIN Asia
TEL: +65 6 779 4909
FAX: +65 6 779 3868
mis@harwin.com.sg

THIS DRAWING AND ANY INFORMATION OR DESCRIPTIVE MATTER SET OUT HEREON ARE CONFIDENTIAL AND COPYRIGHT PROPERTY OF THE HARWIN GROUP AND MUST NOT BE DISCLOSED, LOANED, COPIED OR USED FOR MANUFACTURING, TENDERING OR FOR ANY OTHER PURPOSE WITHOUT THEIR WRITTEN PERMISSION.

TOLERANCES
X. = ±1mm
X.X = ±0.25mm
X.XX = ±0.10mm
X.XXX = ±0.01mm
ANGLES = ±5°
UNLESS STATED

MATERIAL:
SEE ABOVE
FINISH: SEE ABOVE
S/AREA: mm²

TITLE: JACKSCREW DATAMATE
MIXED TECHNOLOGY
CRIMP FEMALE ASSEMBLY

DRAWING NUMBER:
M80-4C10605F1-04-325-00-000

SHT
2 OF 2