

Features

- UltraFast™: Optimized for minimum saturation voltage and operating frequencies up to 40 kHz in hard switching, > 200 kHz in resonant mode
- Very low conduction and switching losses
- Fully isolated package (2,500 Volt AC/RMS)
- Very low internal inductance (≤ 5 nH typ.)
- Industry standard outline

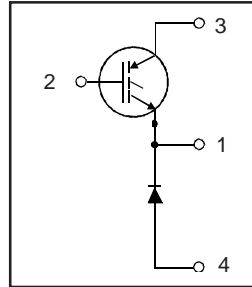

$V_{CES} = 600V$
$V_{CE(on)} \text{ typ.} = 1.49V$
@ $V_{GE} = 15V, I_C = 50A$

Benefits

- Designed for increased operating efficiency in power conversion: PFC, UPS, SMPS, Welding, Induction heating
- Lower overall losses available at frequencies $\geq 20kHz$
- Easy to assemble and parallel
- Direct mounting to heatsink
- Lower EMI, requires less snubbing
- Plug-in compatible with other SOT-227 packages



Absolute Maximum Ratings

	Parameter	Max.	Units
V_{CES}	Collector-to-Emitter Breakdown Voltage	600	V
$I_C @ T_C = 25^\circ C$	Continuous Collector Current	100	A
$I_C @ T_C = 100^\circ C$	Continuous Collector Current	50	
I_{CM}	Pulsed Collector Current	200	
I_{LM}	Clamped Inductive Load Current ^②	200	
V_{GE}	Gate-to-Emitter Voltage	± 20	V
V_{ISOL}	RMS Isolation Voltage, Any Terminal to Case, t=1 min	2500	
$P_D @ T_C = 25^\circ C$	Maximum Power Dissipation	250	W
$P_D @ T_C = 100^\circ C$	Maximum Power Dissipation	100	
T_J	Operating Junction	-55 to + 150	$^\circ C$
T_{STG}	Storage Temperature Range	-55 to + 150	
	Mounting Torque, 6-32 or M3 Screw	12 lbf •in(1.3N•m)	

Thermal Resistance

	Parameter	Typ.	Max.	Units
$R_{\theta JC}$	Junction-to-Case, IGBT	—	0.50	$^\circ C/W$
$R_{\theta JC}$	Thermal Resistance, Junction-to-Case , Diode	—	1.0	
$R_{\theta CS}$	Case-to-Sink, Flat, Greased Surface	0.05	—	
Wt	Weight of Module	30	—	gm

Electrical Characteristics @ T_J = 25°C (unless otherwise specified)

	Parameter	Min.	Typ.	Max.	Units	Conditions
V _{(BR)CES}	Collector-to-Emitter Breakdown Voltage ^③	600	—	—	V	V _{GE} = 0V, I _C = 250μA
ΔV _{(BR)CES/ΔT_J}	Temperature Coeff. of Breakdown Voltage	—	0.36	—	V/°C	V _{GE} = 0V, I _C = 1.0mA
V _{CE(on)}	Collector-to-Emitter Saturation Voltage	—	1.49	2.1	V	I _C = 50A V _{GE} = 15V I _C = 100A See Fig. 1, 4 I _C = 50A, T _J = 150°C
		—	1.80	—		
		—	1.47	—		
V _{GE(th)}	Gate Threshold Voltage	3.0	—	6.0		V _{CE} = V _{GE} , I _C = 250μA
ΔV _{GE(th)/ΔT_J}	Temperature Coeff. of Threshold Voltage	—	-7.6	—	mV/°C	V _{CE} = V _{GE} , I _C = 250μA
g _{fe}	Forward Transconductance ^④	34	52	—	S	V _{CE} = 100V, I _C = 50A
I _{CES}	Zero Gate Voltage Collector Current	—	—	250	μA	V _{GE} = 0V, V _{CE} = 600V
		—	—	1.3	mA	V _{GE} = 0V, V _{CE} = 600V, T _J = 150°C
V _{FM}	Diode Forward Voltage Drop	—	1.3	1.6	V	I _C = 50A See Fig. 12 I _C = 50A, T _J = 150°C
		—	1.16	1.3		
I _{GES}	Gate-to-Emitter Leakage Current	—	—	±100	nA	V _{GE} = ±20V

Switching Characteristics @ T_J = 25°C (unless otherwise specified)

	Parameter	Min.	Typ.	Max.	Units	Conditions
Q _g	Total Gate Charge (turn-on)	—	430	640	nC	I _C = 50A V _{CC} = 400V See Fig. 7 V _{GE} = 15V
Q _{ge}	Gate - Emitter Charge (turn-on)	—	48	72		
Q _{gc}	Gate - Collector Charge (turn-on)	—	130	190		
t _{d(on)}	Turn-On Delay Time	—	57	—	ns	T _J = 25°C I _C = 60A, V _{CC} = 480V V _{GE} = 15V, R _G = 5.0Ω Energy losses include "tail" and diode reverse recovery.
t _r	Rise Time	—	80	—		
t _{d(off)}	Turn-Off Delay Time	—	240	—		
t _f	Fall Time	—	120	—		
E _{on}	Turn-On Switching Loss	—	0.41	—	mJ	
E _{off}	Turn-Off Switching Loss	—	2.51	—		
E _{ts}	Total Switching Loss	—	2.92	4.4		
t _{d(on)}	Turn-On Delay Time	—	57	—	ns	T _J = 150°C, I _C = 60A, V _{CC} = 480V V _{GE} = 15V, R _G = 5.0Ω Energy losses include "tail" and diode reverse recovery.
t _r	Rise Time	—	80	—		
t _{d(off)}	Turn-Off Delay Time	—	380	—		
t _f	Fall Time	—	170	—		
E _{ts}	Total Switching Loss	—	4.78	—	mJ	
L _E	Internal Emitter Inductance	—	2.0	—	nH	
C _{ies}	Input Capacitance	—	7400	—	pF	V _{GE} = 0V V _{CC} = 30V See Fig. 6 f = 1.0MHz
C _{oes}	Output Capacitance	—	730	—		
C _{res}	Reverse Transfer Capacitance	—	90	—		
t _{rr}	Diode Reverse Recovery Time	—	90	140	ns	T _J = 25°C See Fig. 13 T _J = 125°C
		—	120	180		
I _{rr}	Diode Peak Reverse Recovery Current	—	7.3	11	A	T _J = 25°C See Fig. 14 T _J = 125°C
		—	11	16		
Q _{rr}	Diode Reverse Recovery Charge	—	360	550	nC	T _J = 25°C See Fig. 15 T _J = 125°C
		—	780	1200		
di _{(rec)M/dt}	Diode Peak Rate of Fall of Recovery During t _b	—	370	—	A/μs	T _J = 25°C See Fig. 16 T _J = 125°C
		—	220	—		

Details of note ① through ④ are on the page 7

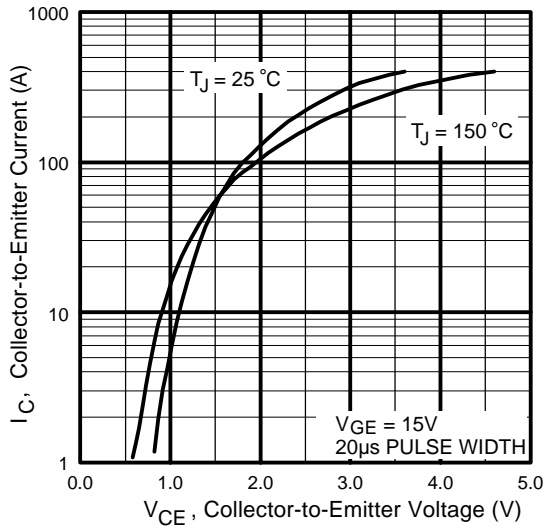

Fig. 1 - Typical Output Characteristics

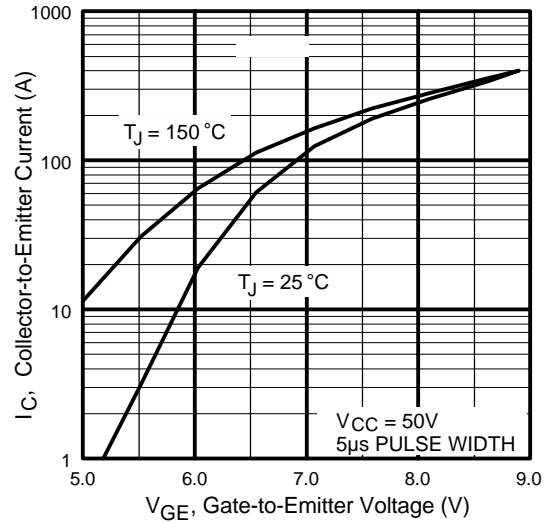

Fig. 2 - Typical Transfer Characteristics

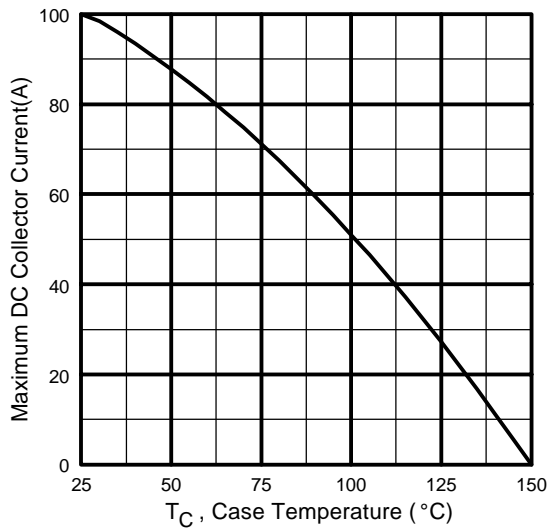

Fig. 3 - Maximum Collector Current vs. Case Temperature

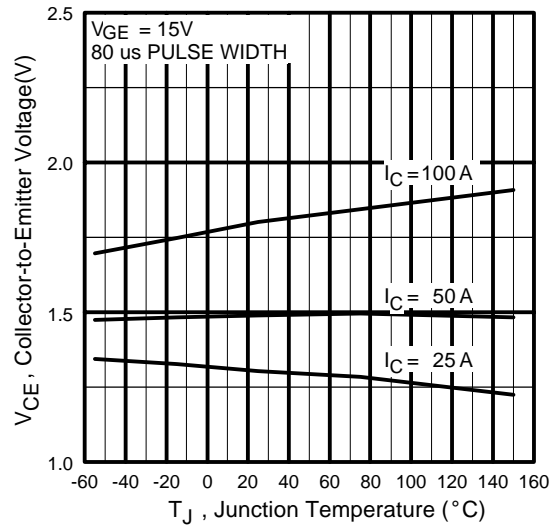

Fig. 4 - Typical Collector-to-Emitter Voltage vs. Junction Temperature

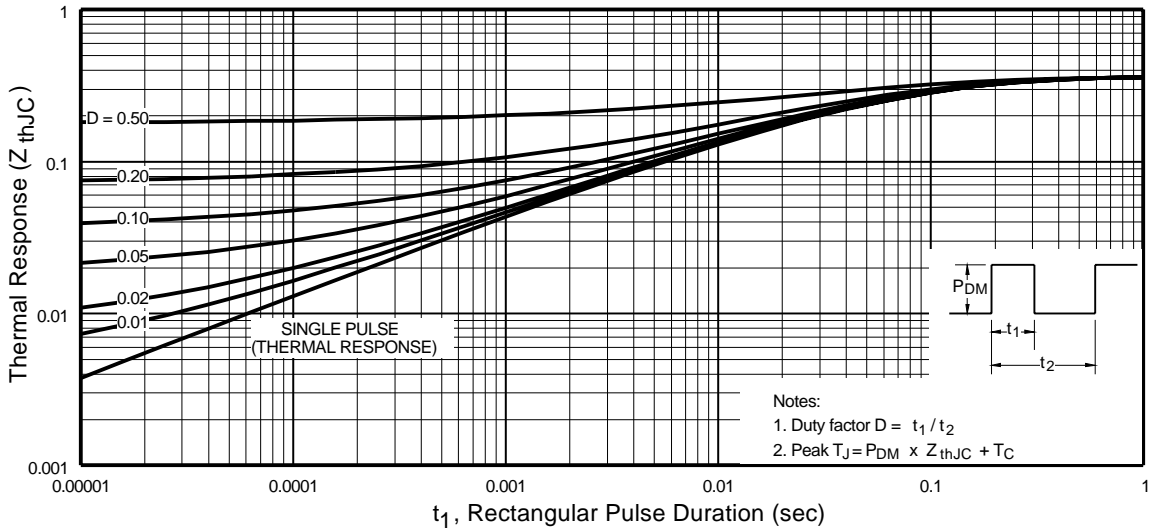

Fig. 5 - Maximum Effective Transient Thermal Impedance, Junction-to-Case

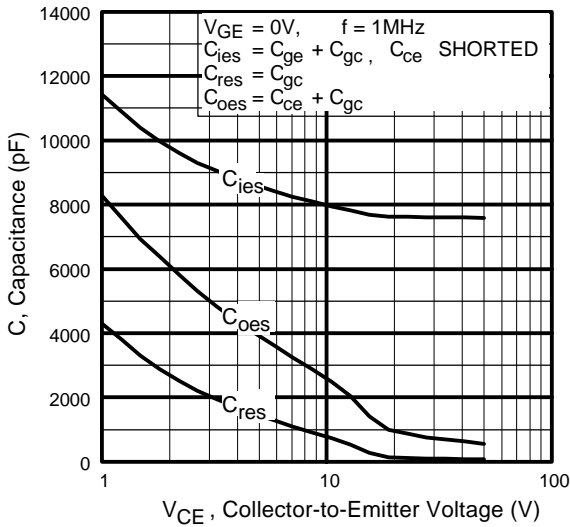

Fig. 6 - Typical Capacitance vs. Collector-to-Emitter Voltage

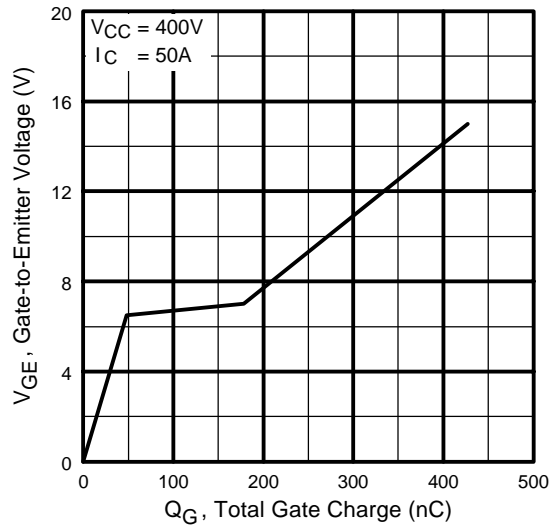

Fig. 7 - Typical Gate Charge vs. Gate-to-Emitter Voltage

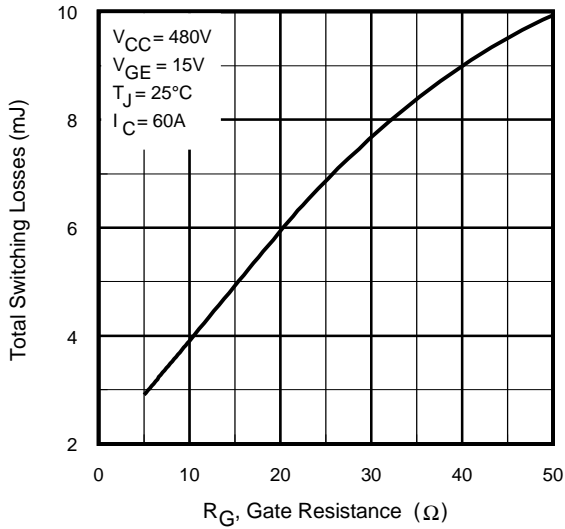

Fig. 8 - Typical Switching Losses vs. Gate Resistance

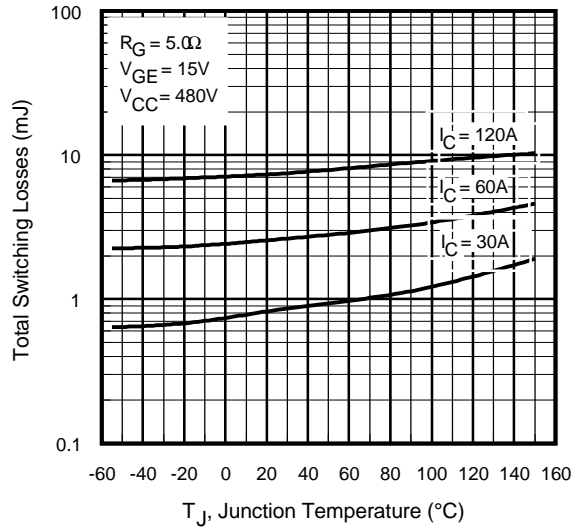

Fig. 9 - Typical Switching Losses vs. Junction Temperature

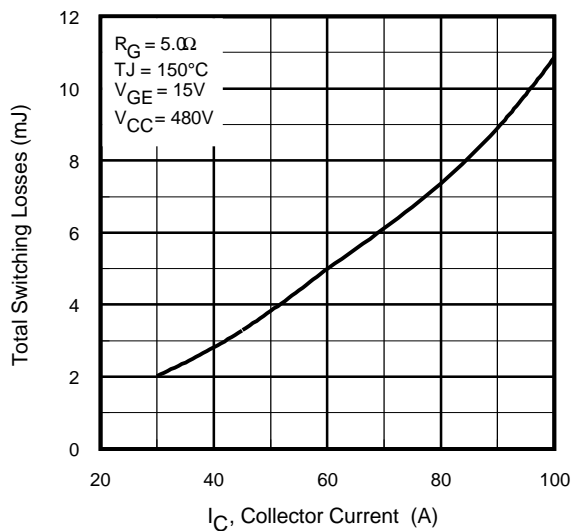

Fig. 10 - Typical Switching Losses vs. Collector-to-Emitter Current

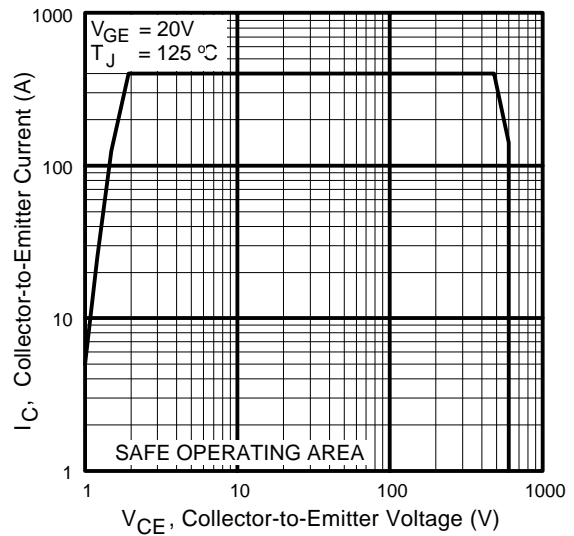

Fig. 11 - Turn-Off SOA

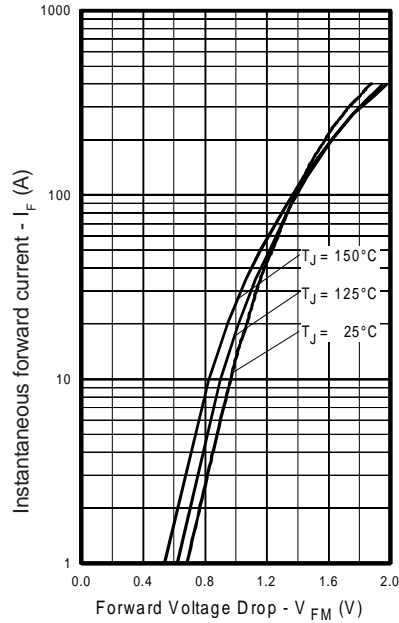

Fig. 12 - Typical Forward Voltage Drop vs. Instantaneous Forward Current

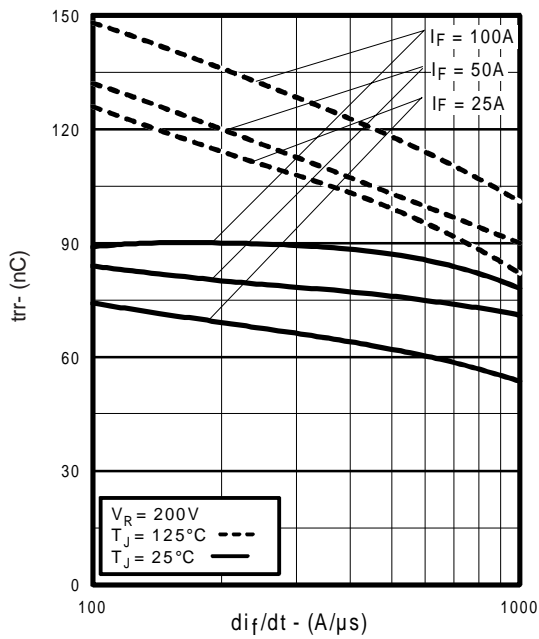

Fig. 13 - Typical Reverse Recovery vs. di_f/dt

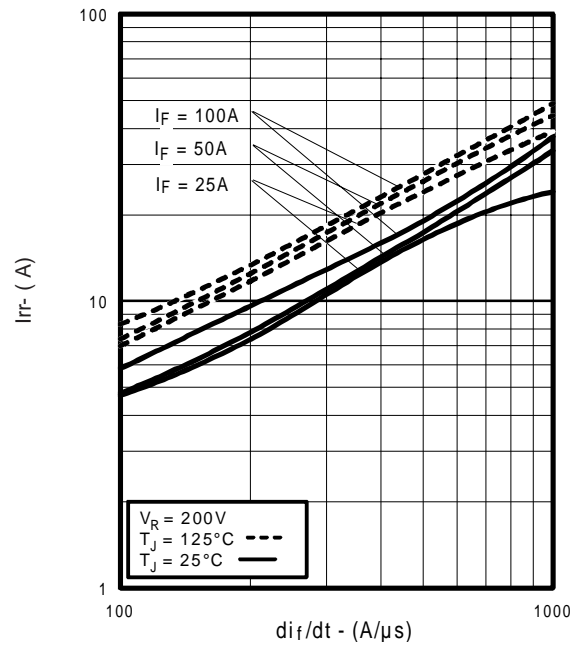

Fig. 14 - Typical Recovery Current vs. di_f/dt

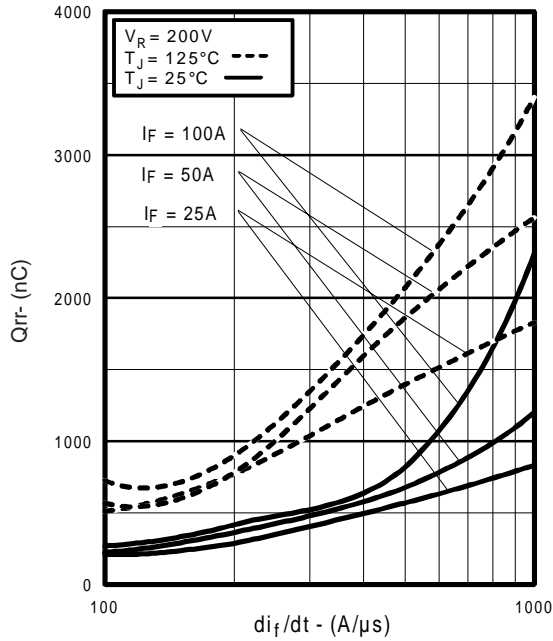

Fig. 15 - Typical Stored Charge vs. di_f/dt

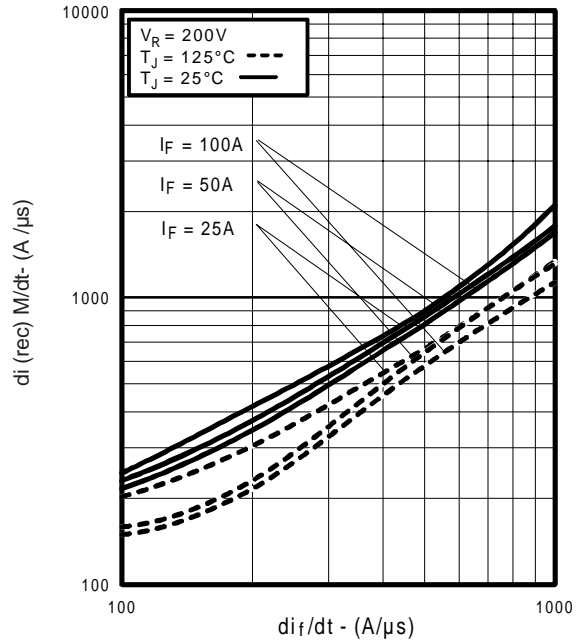

Fig. 16 - Typical $di_{(rec)}M/dt$ vs. di_f/dt

Notes:

- ① Repetitive rating: $V_{GE}=20V$; pulse width limited by maximum junction temperature (figure 20)
- ② $V_{CC}=80\%(V_{CES})$, $V_{GE}=20V$, $L=10\mu H$, $R_G=5.0\Omega$ (figure 19)
- ③ Pulse width $\leq 80\mu s$; duty factor $\leq 0.1\%$.
- ④ Pulse width $5.0\mu s$, single shot.

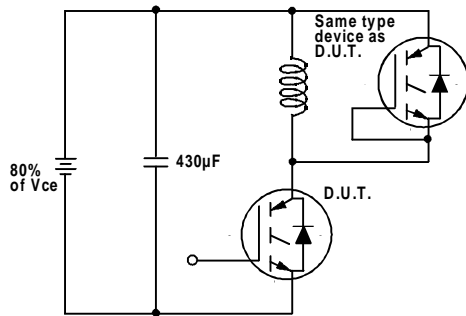

Fig. 17a - Test Circuit for Measurement of I_{LM} , E_{on} , $E_{off(diode)}$, t_{rr} , Q_{rr} , I_{rr} , $t_{d(on)}$, t_r , $t_{d(off)}$, t_f

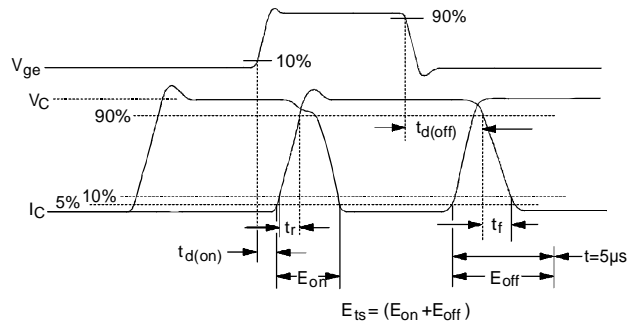

Fig. 17b - Test Waveforms for Circuit of Fig. 17a, Defining E_{off} , $t_{d(off)}$, t_f

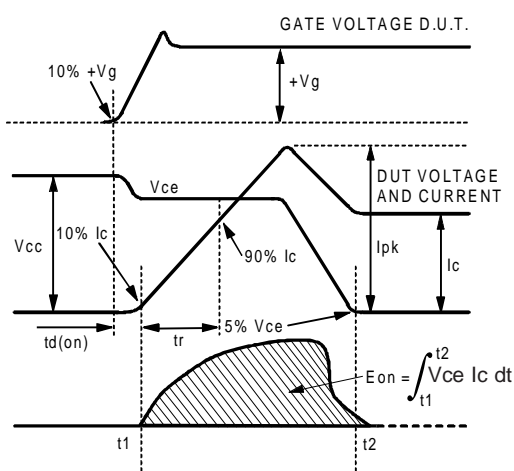

Fig. 17c - Test Waveforms for Circuit of Fig. 17a, Defining E_{on} , $t_{d(on)}$, t_r

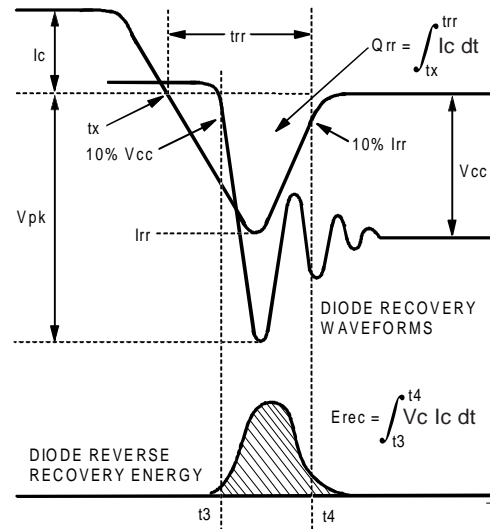

Fig. 17d - Test Waveforms for Circuit of Fig. 17a, Defining E_{rec} , t_{rr} , Q_{rr} , I_{rr}

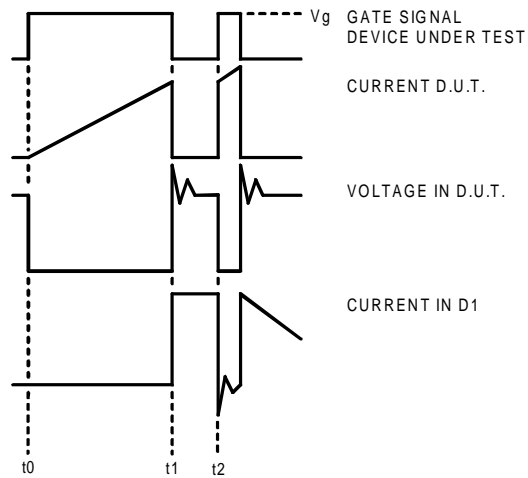

Figure 17e. Macro Waveforms for Figure 17a's Test Circuit

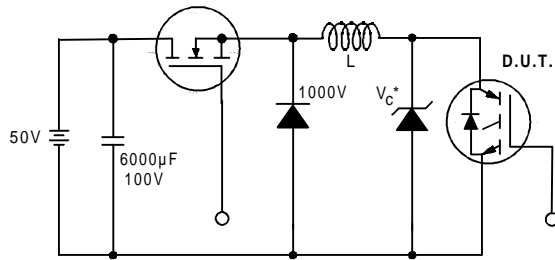

Figure 18. Clamped Inductive Load Test Circuit

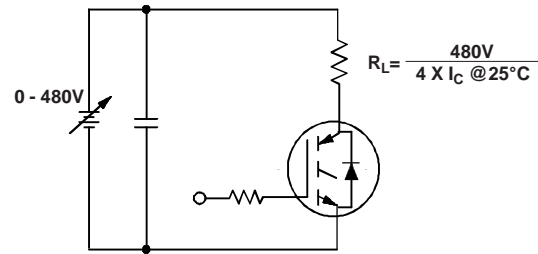

Figure 19. Pulsed Collector Current Test Circuit

GA100NA60U

International
IR Rectifier

SOT-227 Package Details

Dimensions are shown in millimeters (inches)

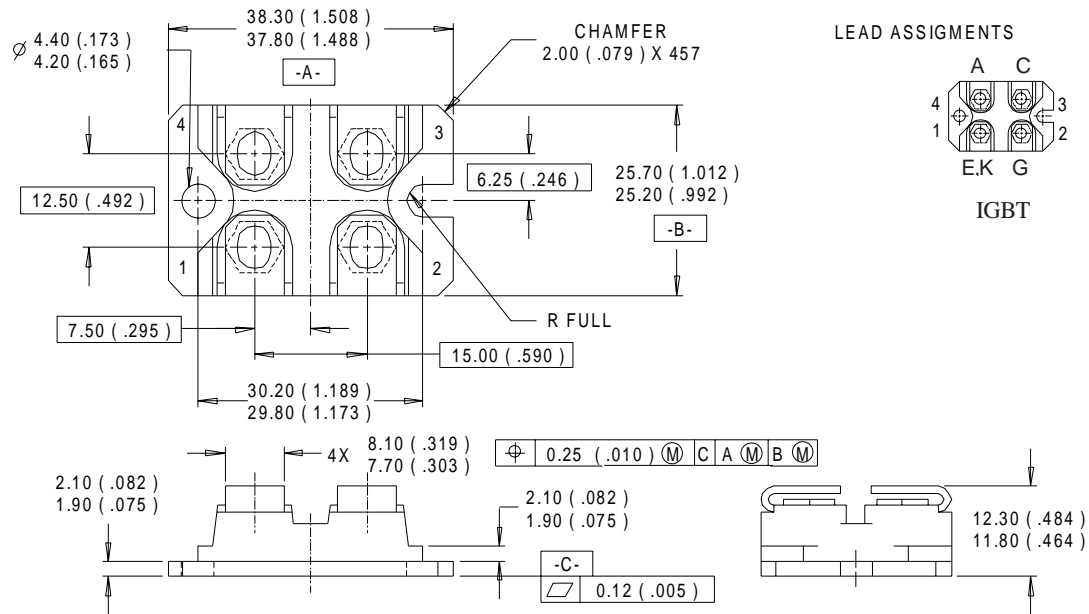

Tube

QUANTITIES PER TUBE IS 10
 M4 SCREW AND WASHER INCLUDED

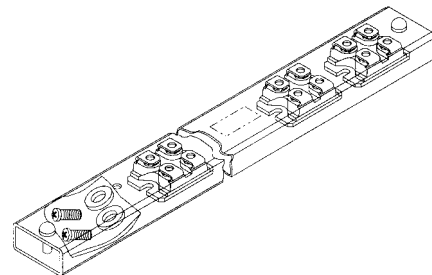

Data and specifications subject to change without notice.
 This product has been designed and qualified for the Industrial market.
 Qualification Standards can be found on IR's Web site.

International
IR Rectifier

IR WORLD HEADQUARTERS: 233 Kansas St., El Segundo, California 90245, USA Tel: (310) 252-7105
 TAC Fax: (310) 252-7903

Visit us at www.irf.com for sales contact information.7/01

www.irf.com