

General Description

This planar stripe MOSFET has better characteristics, such as fast switching time, low on resistance, low gate charge and excellent avalanche characteristics. It is mainly suitable for electronic ballast and switch mode power supplies.

FEATURES

- $V_{DSS}=200V$, $I_D=9.5A$
- Drain-Source ON Resistance
: $R_{DS(ON)}=400m$ @ $V_{GS} = 10V$
- $Q_g(\text{typ.})=18.5nC$

MAXIMUM RATING (Tc=25)

CHARACTERISTIC	SYMBOL	RATING		UNIT	
		KHB9D5N20P	KHB9D5N20F KHB9D5N20F2		
Drain-Source Voltage	V_{DSS}	200		V	
Gate-Source Voltage	V_{GSS}	± 30		V	
Drain Current	@ $T_C=25$	I_D	9.5	9.5*	A
	Pulsed (Note1)	I_{DP}	38	38*	
Single Pulsed Avalanche Energy (Note 2)	E_{AS}	180		mJ	
Repetitive Avalanche Energy (Note 1)	E_{AR}	8.7		mJ	
Peak Diode Recovery dv/dt (Note 3)	dv/dt	5.5		V/ns	
Drain Power Dissipation	$T_c=25$	P_D	87	40	W
	Derate above 25		0.7	0.32	
Maximum Junction Temperature	T_j	150			
Storage Temperature Range	T_{stg}	-55 150			
Thermal Characteristics					
Thermal Resistance, Junction-to-Case	R_{thJC}	1.44	3.13	/W	
Thermal Resistance, Junction-to-Ambient	R_{thJA}	62.5	62.5	/W	

* : Drain current limited by maximum junction temperature.

PIN CONNECTION

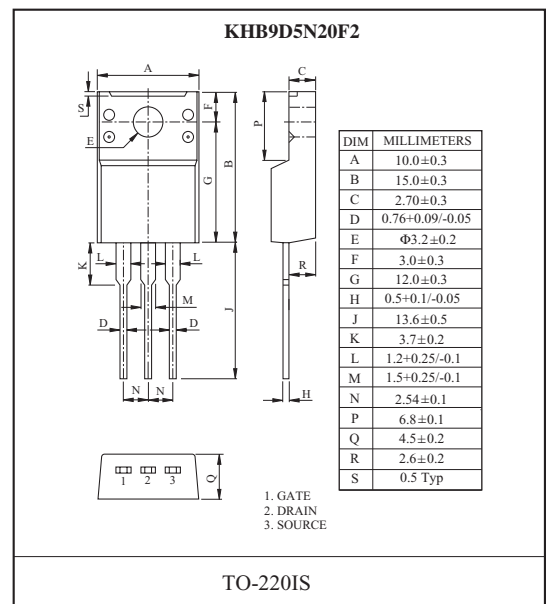
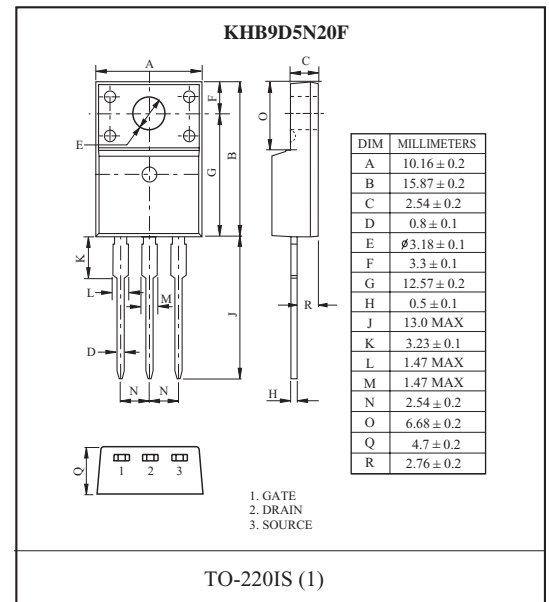
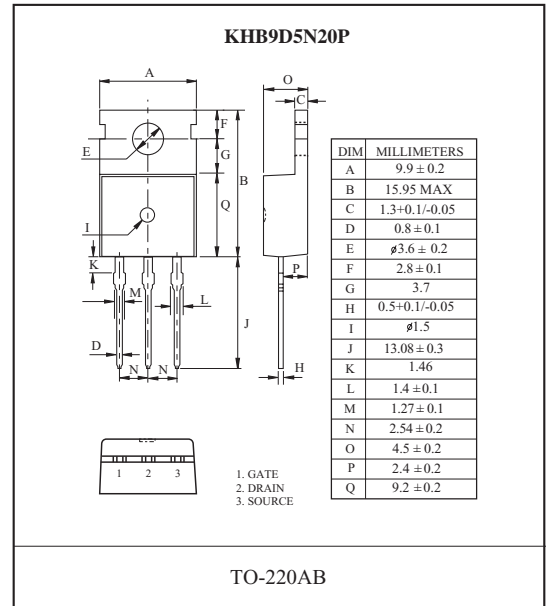
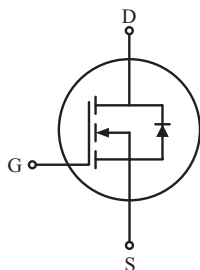

ELECTRICAL CHARACTERISTICS (Tc=25)

CHARACTERISTIC	SYMBOL	TEST CONDITION	MIN.	TYP.	MAX.	UNIT
Static						
Drain-Source Breakdown Voltage	BV_{DSS}	$I_D=250\ \mu A, V_{GS}=0V$	200	-	-	V
Breakdown Voltage Temperature Coefficient	BV_{DSS}/T_j	$I_D=250\ \mu A$, Referenced to 25	-	0.19	-	V/
Gate Threshold Voltage	V_{th}	$V_{DS}=V_{GS}, I_D=250\ \mu A$	2.0	-	4.0	V
Drain Cut-off Current	I_{DSS}	$V_{DS}=200V, V_{GS}=0V,$	-	-	1	μA
Gate Leakage Current	I_{GSS}	$V_{GS}=\pm 30V, V_{DS}=0V$	-	-	± 100	nA
Drain-Source ON Resistance	$R_{DS(ON)}$	$V_{GS}=10V, I_D=4.75A$	-	345	400	m
Forward Transconductance	g_{FS}	$V_{DS}=40V, I_D=4.75A$ (Note4)	-	6.7	-	S
Dynamic						
Total Gate Charge	Q_g	$V_{DS}=160V, I_D=9.5A$ $V_{GS}=10V$ (Note4, 5)	-	18.5	23	nC
Gate-Source Charge	Q_{gs}		-	2.7	-	
Gate-Drain Charge	Q_{gd}		-	9	-	
Turn-on Delay time	$t_{d(on)}$	$V_{DD}=100V, R_G=25$ $I_D=9.5A$ (Note4, 5)	-	11	32	ns
Turn-on Rise time	t_r		-	62	135	
Turn-off Delay time	$t_{d(off)}$		-	46	102	
Turn-off Fall time	t_f		-	80	170	
Input Capacitance	C_{iss}	$V_{DS}=25V, V_{GS}=0V, f=1.0MHz$	-	387	503	pF
Output Capacitance	C_{oss}		-	96	125	
Reverse Transfer Capacitance	C_{rss}		-	34	45	
Source-Drain Diode Ratings						
Continuous Source Current	I_S	$V_{GS}<V_{th}$	-	-	9.5	A
Pulsed Source Current	I_{SP}		-	-	38	
Diode Forward Voltage	V_{SD}	$I_S=9.5A, V_{GS}=0V$	-	-	1.5	V
Reverse Recovery Time	t_{rr}	$I_S=9.5A, V_{GS}=0V,$	-	130	-	ns
Reverse Recovery Charge	Q_{rr}	$dI_S/dt=100A/\mu s$ (Note 4)	-	0.6	-	μC

Note 1) Repetivity rating : Pulse width limited by junction temperature.

Note 2) $L=3mH, I_{AS}=9.5A, V_{DD}=50V, R_G=25$, Starting $T_j=25$.

Note 3) $I_S=9.5A, dI/dt=300A/\mu s, V_{DD}=BV_{DSS}$, Starting $T_j=25$.

Note 4) Pulse Test : Pulse width $300\mu s$, Duty Cycle 2%.

Note 5) Essentially independent of operating temperature.

Fig1. $I_D - V_{DS}$

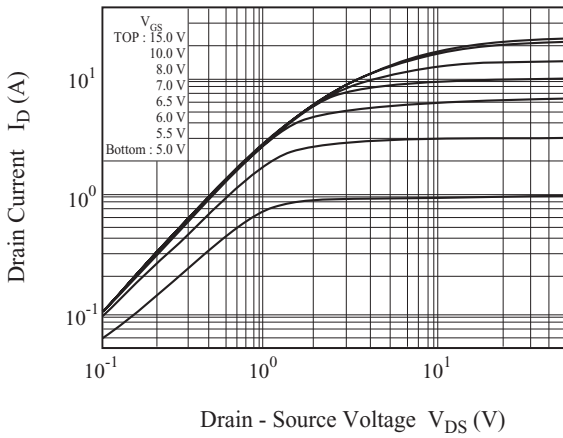

Fig2. $I_D - V_{GS}$

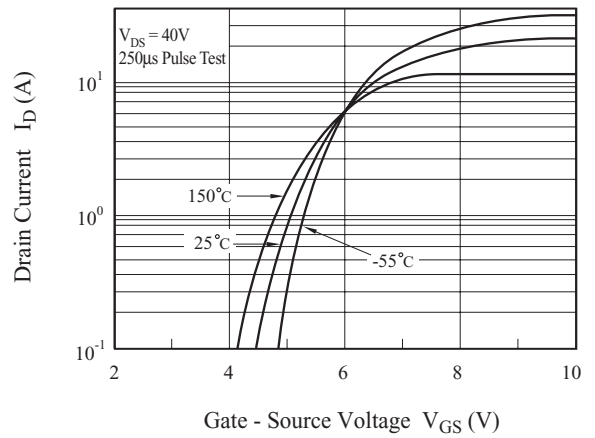

Fig4. $BV_{DSS} - T_j$

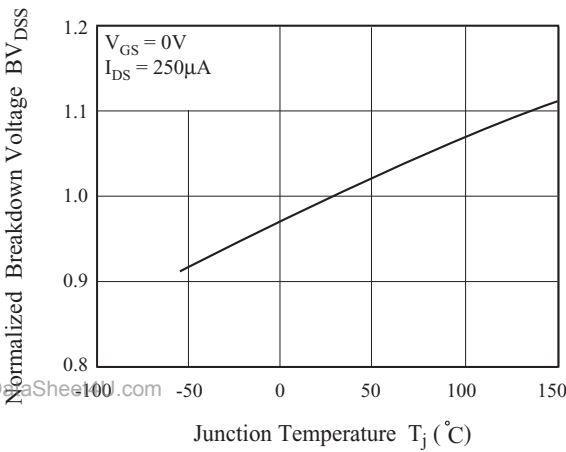

Fig5. $R_{DS(ON)} - I_D$

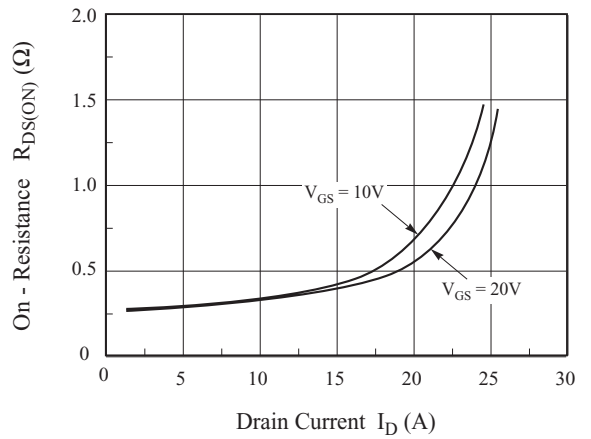

Fig6. $I_S - V_{SD}$

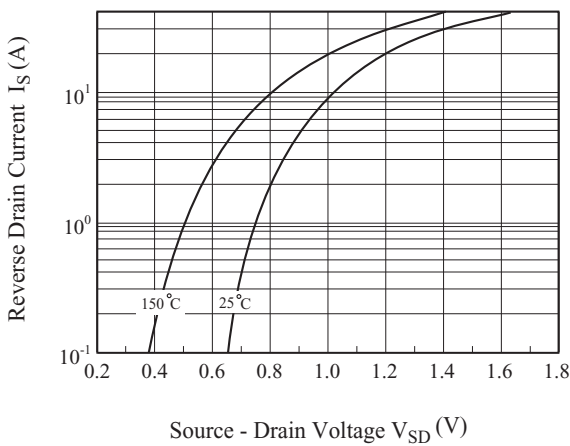

Fig6. $R_{DS(ON)} - T_j$

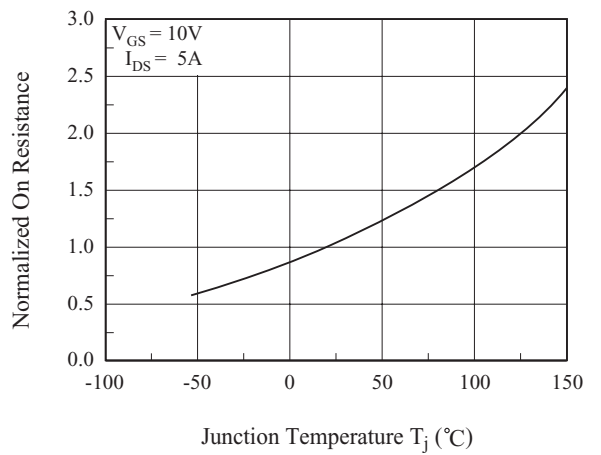

Fig7. C - V_{DS}

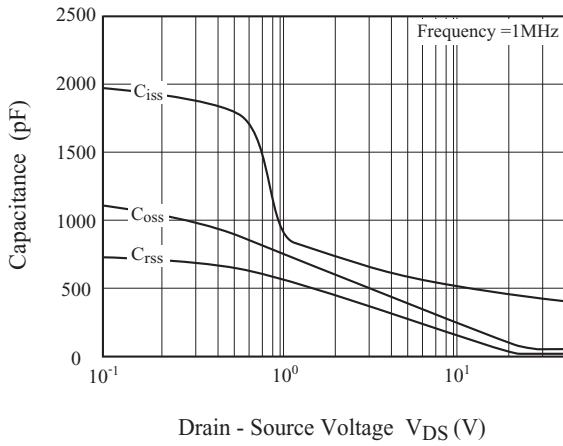

Fig8. Q_g- V_{GS}

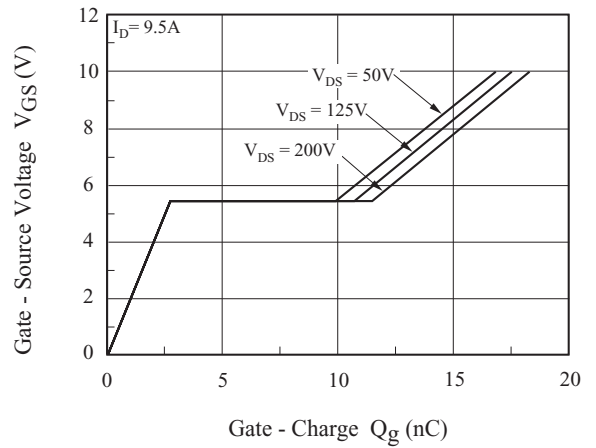

Fig9. Safe Operation Area

(KHB9D5N20P)

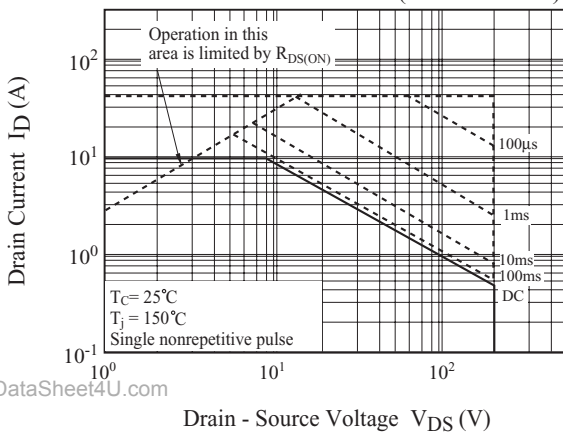

Fig10. Safe Operation Area

(KHB9D5N20F, KHB9D5N20F2)

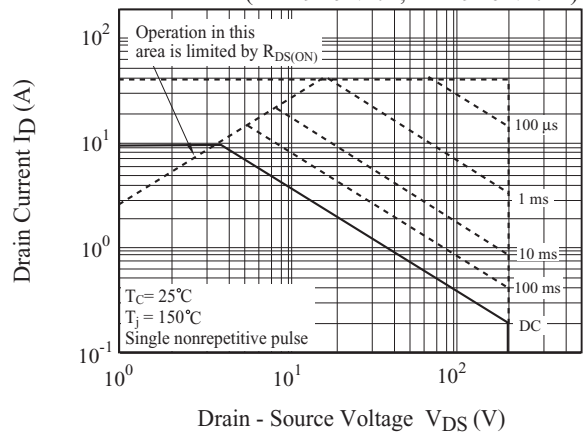

Fig11. I_D - T_j

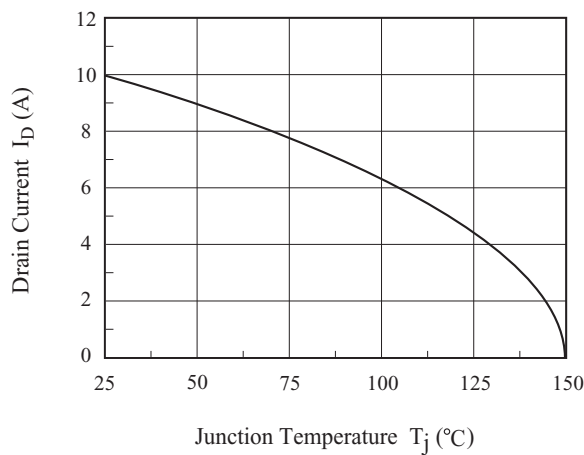

Fig12. Transient Thermal Response Curve

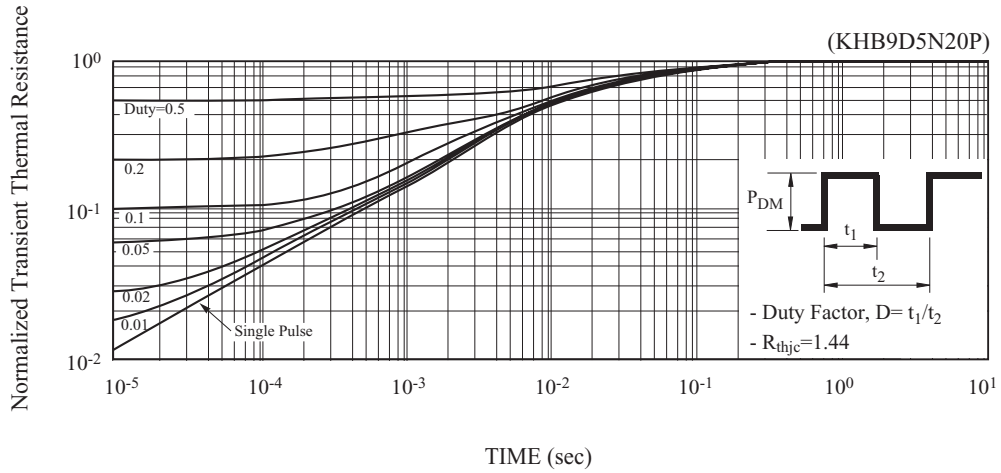
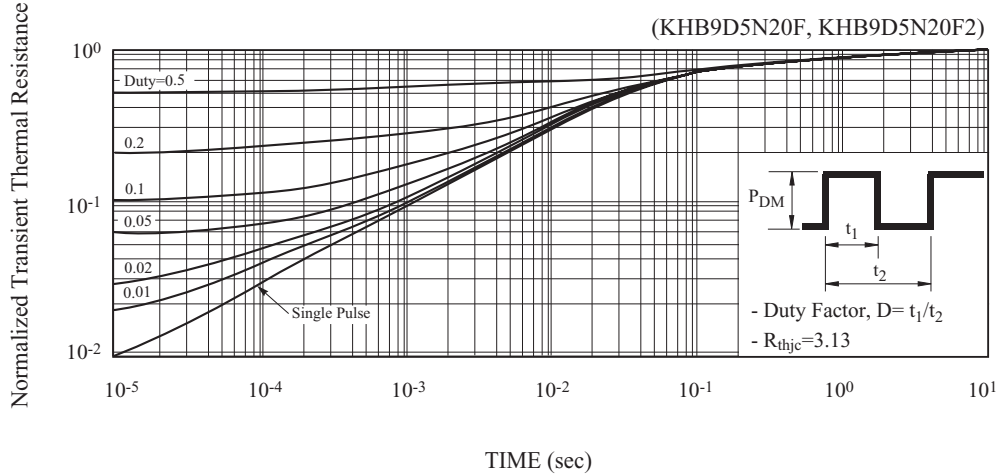

Fig13. Transient Thermal Response Curve



www.DataSheet4U.com

Fig14. Gate Charge

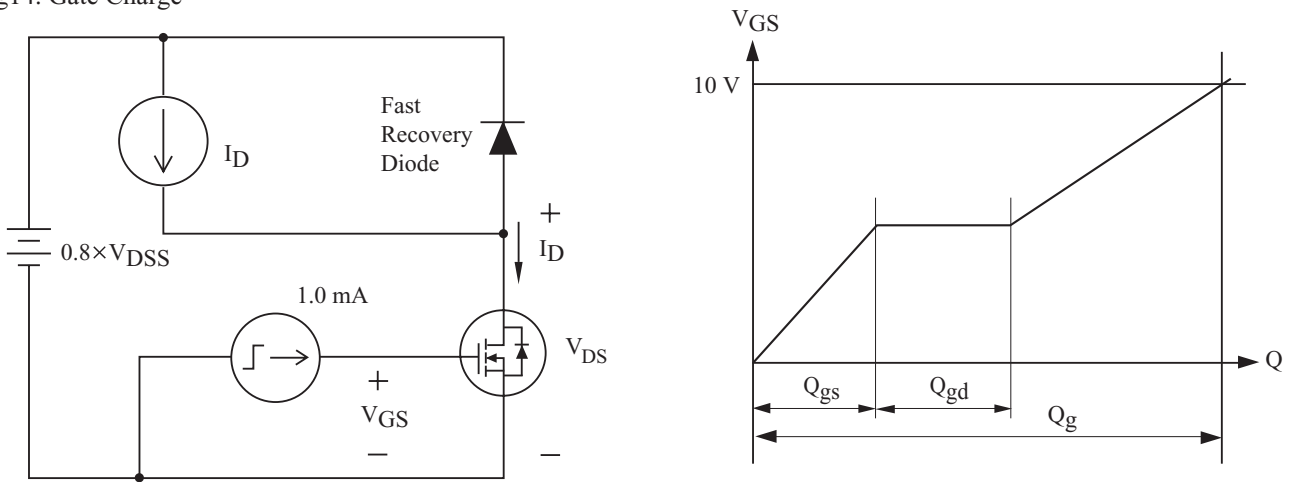

Fig15. Single Pulsed Avalanche Energy

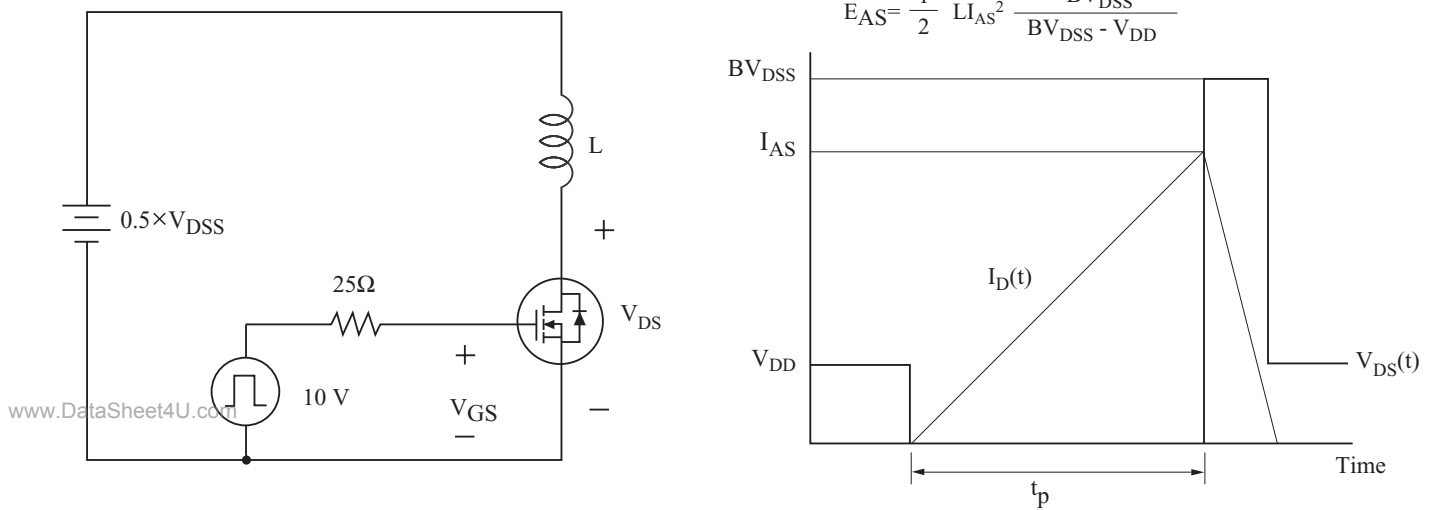

Fig16. Resistive Load Switching

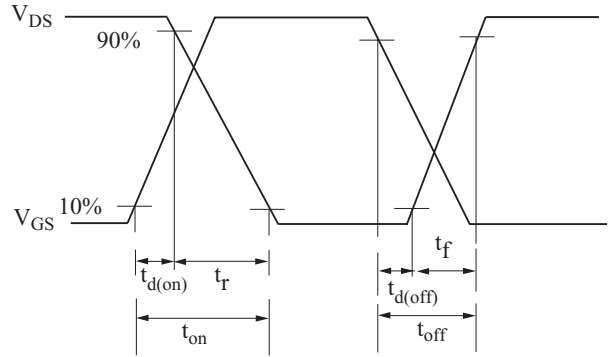
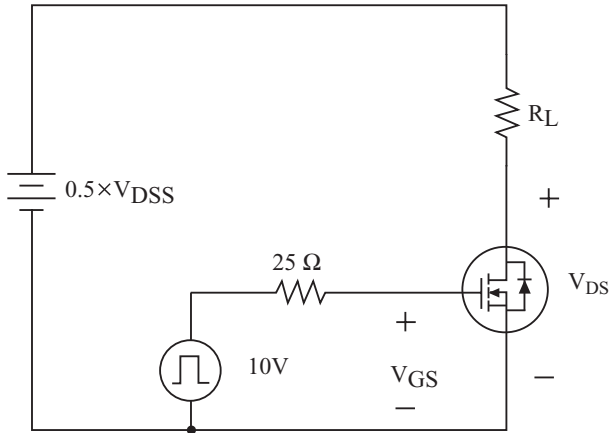
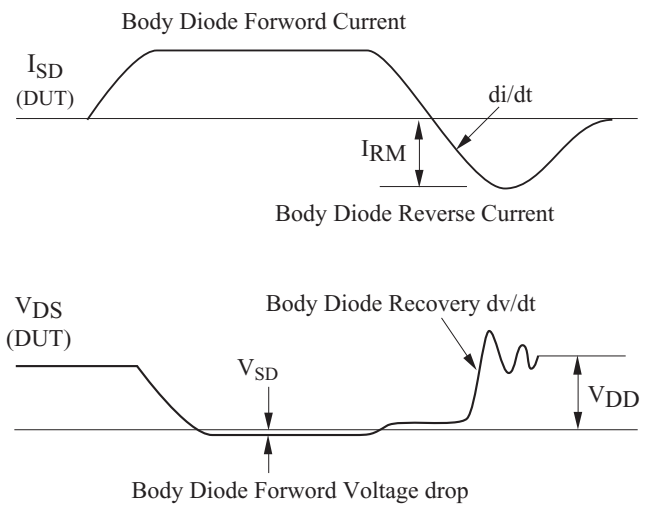
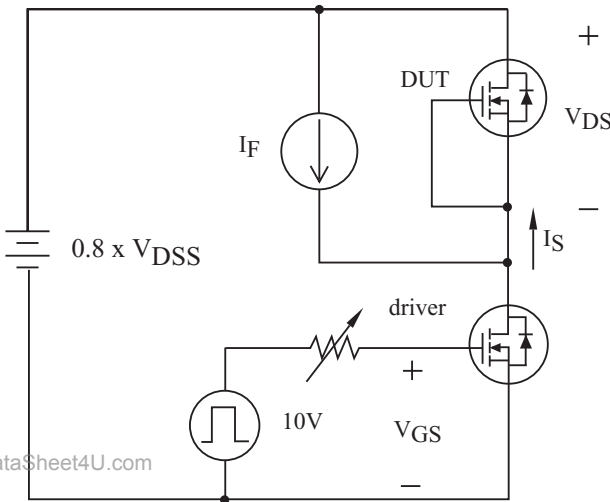

Fig17. Source - Drain Diode Reverse Recovery and dv/dt



www.DataSheet4U.com