

# LCD Module Technical Specification

Type No. **T-51512D121J-FW-A-AFN**



Approved by (Quality Assurance Division)



Checked by (ACI Engineering Division)

*S.Sano*

Prepared by (ACI Engineering Division)

No.	Item	Page
--	CONTENTS	1
1	APPLICATION	2
2	OVERVIEW	3
3	ABSOLUTE MAXIMUM RATINGS	4
4	ELECTRICAL CHARACTERISTICS	4
5	INTERFACE PIN CONNECTION	7
6	INTERFACE TIMING	9
7	BLOCK DIAGRAM	13
8	MECHANICAL SPECIFICATION	14
9	OPTICAL CHARACTERISTICS	16
10	RELIABILITY TEST CONDITION	19
11	INSPECTION STANDARDS	20
12	OTHER FEATURE	21
13	HANDLING PRECAUTIONS FOR TFT-LCD MODULE	22
--	PACKAGING SPECIFICATION	25
--	PRODUCTS NUMBER LABELING FORMS	29
--	LAMP UNIT for 12.1" SVGA	31

# 1. APPLICATION

This specification applies to color TFT-LCD module, T-51512D121J-FW-A-AFN.

These specification papers are the proprietary product of OPTREX and include materials protected under copyright of OPTREX. No part of this document may be reproduced in any form or by any means without the express written permission of OPTREX.

OPTREX does not assume any liability for infringement of patents, copyrights or other intellectual property rights of third parties by or arising from use of a product specified in this document. No license, express, implied or otherwise, is granted under any patents, copyrights or other intellectual property rights of OPTREX or of others.

OPTREX classifies the usage of the TFT-LCD module as follows. Please confirm the usage before using the product.

## (1) Standard Usage

Computers, office equipment, factory automation equipment, test and measurement equipment, communications, transportation equipment(automobiles, ships, trains, etc.), provided, however, that operation is not influenced by TFT-LCD directly.

## (2) Special Usage

Medical equipment, safety equipment, transportation equipment, provided, however, that TFT-LCD is necessary to its operation.

## (3) Specific Usage

Cockpit Equipment, military systems, aerospace equipment, nuclear reactor control systems, life support systems and any other equipment. OPTREX should make a contract that stipulate apportionment of responsibilities between OPTREX and our customer.

The product specified in this document is designed for "Standard Usage" unless otherwise specified in this document. If customers intend to use the product for applications other than those specified for "Standard Usage", they should contact OPTREX sales representative in advance.

OPTREX has been making continuous effort to improve the reliability of its products. Customers should implement sufficient reliability design of their application equipments such as redundant system design, fail-safe functions, anti-failure features.

OPTREX assumes no responsibility for any damage resulting from the use of the product that does not comply with the instructions and the precautions specified in this document.

Please contact and consult a OPTREX sales representative for any questions regarding this product.

## 2. OVERVIEW

T-51512D121J-FW-A-AFN is 12.1" color TFT-LCD (Thin Film Transistor Liquid Crystal Display) module composed of LCD panel, driver ICs, control circuit, and backlight unit.

By applying 6 bit digital data, 800 × 600, 262 K-color images are displayed on the 12.1" diagonal screen. Input power voltage is single 3.3V for LCD driving.

The type of data and control signals are digital and transmitted via CMOS interface per Typ. 40 MHz clock cycle.

Inverter for backlight is not included in this module. General specifications are summarized in the following table:

ITEM	SPECIFICATION
Display Area (mm)	246.0(H) × 184.5(V) (12.106-inch diagonal)
Number of Dots	800 × 3 (H) × 600 (V)
Pixel Pitch (mm)	0.3075 (H) × 0.3075 (V)
Color Pixel Arrangement	RGB vertical stripe
Display Mode	Normally white TN
Number of Color	262 K
Luminance (cd/m <sup>2</sup> )	400
Wide Viewing Angle Technology	Optical compensation film
Surface Treatment	Antiglare and hard-coating 3H
Viewing Angle (CR ≥ 10)	-65~65° (H) -75~45° (V)
Electrical Interface	CMOS
Optimum Viewing Angle(Contrast ratio)	6 o'clock
Module Size (mm)	280.0 (W) × 210.0 (H) × 12.0 (D)
Module Mass (g)	720
Backlight Unit	CCFL, 2-tubes, edge-light, replaceable

Characteristic value without any note is typical value.

### 3. ABSOLUTE MAXIMUM RATINGS

ITEM	SYMBOL	MIN.	MAX	UNIT
Power Supply Voltage for LCD	VCC	-0.3	4.0	V
Logic Input Voltage	VI	-0.3	6.0	V
Lamp Voltage	VL	0	2000	Vrms
Lamp Current	IL	0	18	mArms
Lamp Frequency	FL	--	80	kHz
Operation Temperature(Panel) <small>Note 1,2)</small>	T <sub>op</sub> (Panel)	-20	70	°C
Operation Temperature(Ambient) <small>Note 2)</small>	T <sub>op</sub> (Ambient)	-20	70	°C
Storage Temperature <small>Note 2)</small>	T <sub>stg</sub>	-20	80	°C

[Note]

1) Measured at the center of active area and at the center of panel back surface

2) Top, Tstg ≤ 40°C : 90%RH max. without condensation

Top, Tstg > 40°C : Absolute humidity shall be less than the value of 90%RH at 40°C without condensation.

### 4. ELECTRICAL CHARACTERISTICS

(1) TFT-LCD

Ambient temperature: Ta = 25°C

ITEM	SYMBOL	MIN.	TYP.	MAX.	UNIT	Remarks
Power Supply Voltage for LCD	VCC	3.0	3.3	3.6	V	*1)
Power Supply Current for LCD	ICC	--	340	500	mA	*2)
Permissive Input Ripple Voltage	VRP	--	--	100	mVp-p	VCC = +3.3V
Logic Input Voltage	High	VIH	2.0	--	5.5	V
	Low	VIL	0	--	0.8	V

\*1) Power and signals sequence:

t1 ≤ 10 ms                      200 ms ≤ t4  
 0 < t2 ≤ 50 ms                200 ms ≤ t5  
 0 < t3 ≤ 50 ms                0 ≤ t6

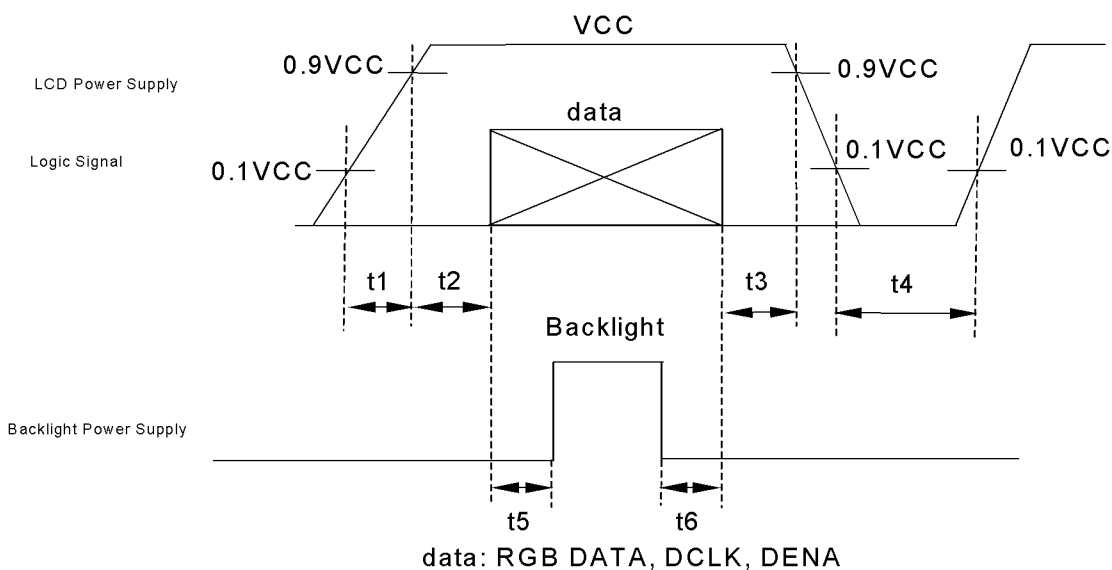

VCC-dip conditions:

- 1) When  $2.4\text{ V} \leq VCC < 3.0\text{ V}$ ,  $t_d \leq 10\text{ ms}$
- 2) When  $VCC < 2.4\text{ V}$

VCC-dip conditions should also follow the power and signals sequence.

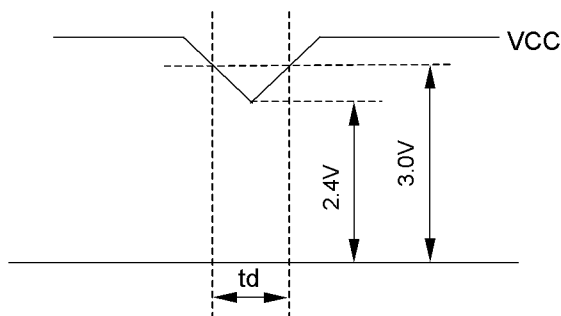

\*2) Typical current condition:

64-gray-bar pattern

600 line mode

$VCC = +3.3\text{ V}$ ,  $f_H=37.9\text{kHz}$ ,  $f_V=60.3\text{Hz}$ ,  $f_{CLK}= 40\text{MHz}$

(2) Backlight

$T_a = 25^\circ\text{C}$

ITEM	SYMBOL	MIN.	TYP.	MAX.	UNIT	Remarks
Lamp Voltage	VL	--	540	--	Vrms	$IL = 12.0\text{ mArms}$
Lamp Current	IL	6.0	12.0	14.0	mArms	* 2), *6)
Lamp Frequency	FL	30	--	60	kHz	*3)
Starting Lamp Voltage	VS	1000	--	--	Vrms	$T_a = 25^\circ\text{C}$
		1200	--	--		$T_a = 0^\circ\text{C}$
		1290	--	--		$T_a = -20^\circ\text{C}$
Lamp Life Time	LT	50,000	--	--	h	* 4),*5) $IL = 12.0\text{ mArms}$ , Continuous operation

[Note]

\*1) Please use synchronous inverter.

\*2) Lamp Current measurement method (The current meter is inserted in low voltage line.)

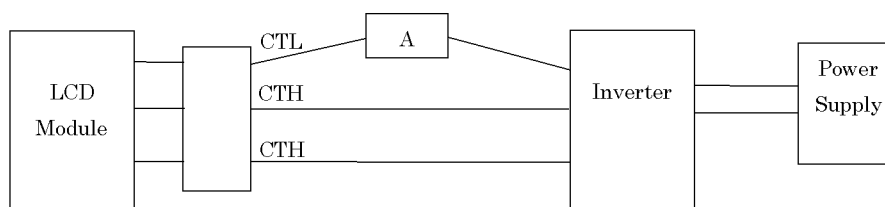

\*3) Lamp frequency of inverter may produce interference with horizontal synchronous frequency, and this may cause horizontal beat on the display. Therefore, please adjust lamp frequency, and keep inverter as far from module as possible or use electronic shielding between inverter and module to avoid the interference.

\*4) Lamp life time is defined as the time either when the brightness becomes 50% of the initial value, or when the starting lamp voltage does not meet the value specified in this table.

\*5) The life time of the backlight depends on the ambient temperature. The life time will decrease under low/high temperature.

\*6) Please use the inverter which has symmetrical current wave form as follows,

The degree of unbalance: less than 10%

The ratio of wave height: less than  $\sqrt{2} \pm 10\%$

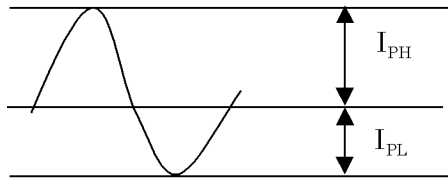

$I_{PH}$ : High side peak

$I_{PL}$ : Low side peak

The degree of unbalance = $ I_{PH} - I_{PL}  / I_{rms} \times 100(\%)$ The ratio of wave height = $I_{PH}(\text{or } I_{PL}) / I_{rms}$
--

CURRENT WAVE FORM

## 5. INTERFACE PIN CONNECTION

### (1) CN 1(INTERFACE SIGNAL)

Used connector: DF9B-41P-1V(32)(Hirose) Corresponding connector: DF9B-41S-1V(Hirose)

Pin No.	Symbol	Function
1	GND	Signal ground
2	DCLK	Clock signal for sampling catch data signal
3	GND	Signal ground
4	HD	Horizontal sync signal *1)
5	VD	Vertical sync signal *1)
6	GND	Signal ground
7	GND	Signal ground
8	GND	Signal ground
9	R0	RED data signal(LSB)
10	R1	RED data signal
11	R2	RED data signal
12	GND	Signal ground
13	R3	RED data signal
14	R4	RED data signal
15	R5	RED data signal(MSB)
16	GND	Signal ground
17	GND	Signal ground
18	GND	Signal ground
19	G0	GREEN data signal(LSB)
20	G1	GREEN data signal
21	G2	GREEN data signal
22	GND	Signal ground
23	G3	GREEN data signal
24	G4	GREEN data signal
25	G5	GREEN data signal(MSB)
26	GND	Signal ground
27	GND	Signal ground
28	GND	Signal ground
29	B0	BLUE data signal (LSB)
30	B1	BLUE data signal
31	B2	BLUE data signal
32	GND	Signal ground
33	B3	BLUE data signal
34	B4	BLUE data signal
35	B5	BLUE data signal(MSB)
36	GND	Signal ground
37	DENA	Data enable signal(to settle the viewing area)
38	GND	Signal ground
39	VCC	+3.3 V Power supply
40	VCC	+3.3 V Power supply
41	SC	Scan direction control.(Low:Normal, High:Reverse)

\*1)HD and VD are not being used for timing control.

\*2)The shielding case is connected with GND.

(2)CN 2(BACKLIGHT)

Backlight-side connector: BHR-04VS-1 (JST)

Inverter-side connector: SM04(4.0)B-BHS-1(JST)

Pin No.	Symbol	Function
1, 2	CTH	VBLH (High voltage)
4	CTL	VBLL (Low voltage)

[Note]  $VBLH - VBLL = VL$



## 6. INTERFACE TIMING

### (1) Timing Specifications

ITEM		SYMBOL	MIN.	TYP.	MAX.	UNIT	
DCLK	Frequency	$f_{CLK}$	35	40	42	MHz	
	Period	$t_{CLK}$	23.8	25	28.6	ns	
	Low Width	$t_{WCL}$	10	--	--	ns	
	High Width	$t_{WCH}$	10	--	--	ns	
DATA (R,G,B,DENA)	Set up time	$t_{DS}$	4	--	--	ns	
	Hold time	$t_{DH}$	4	--	--	ns	
DENA	Horizontal	Active Time	$t_{HA}$	800	800	800	$t_{CLK}$
		Blanking Time	$t_{HB}$	20	256	--	$t_{CLK}$
		Frequency	$f_H$	35.2	37.9	39.2	kHz
		Period	$t_H$	25.5	26.4	28.4	$\mu s$
	Vertical	Active Time	$t_{VA}$	600	600	600	$t_H$
		Blanking Time	$t_{VB}$	3	28	--	$t_H$
		Frequency	$f_V$	55	60	64.2	Hz
		Period	$t_V$	15.6	16.7	18.2	ms

[Note]

- 1) DATA is latched at fall edge of DCLK in this specification.
- 2) DENA (Data Enable) should always be positive polarity as shown in the timing specification.
- 3) DCLK should appear during all invalid period,

(2) Timing Chart

a. Pixel Timing Chart

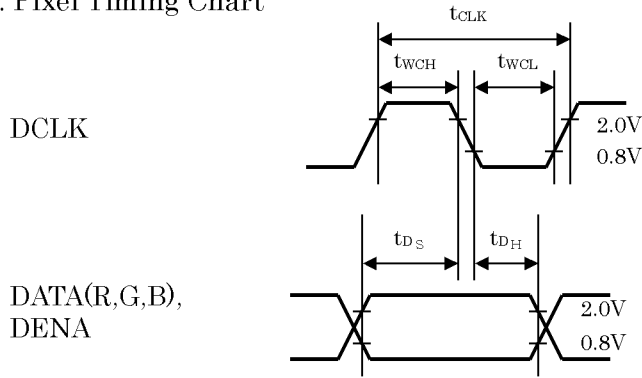

b. Horizontal Timing Chart

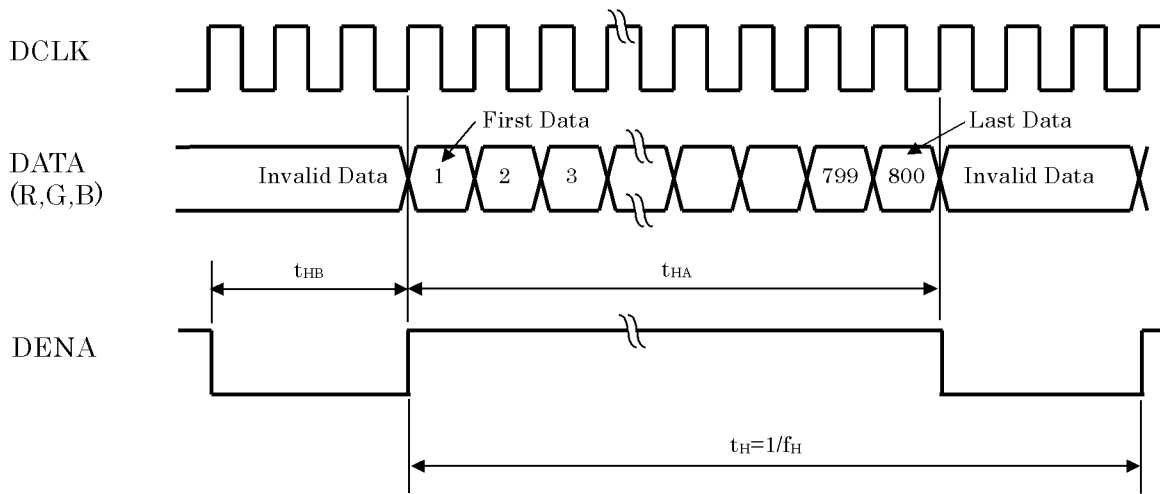

c. Vertical Timing Chart

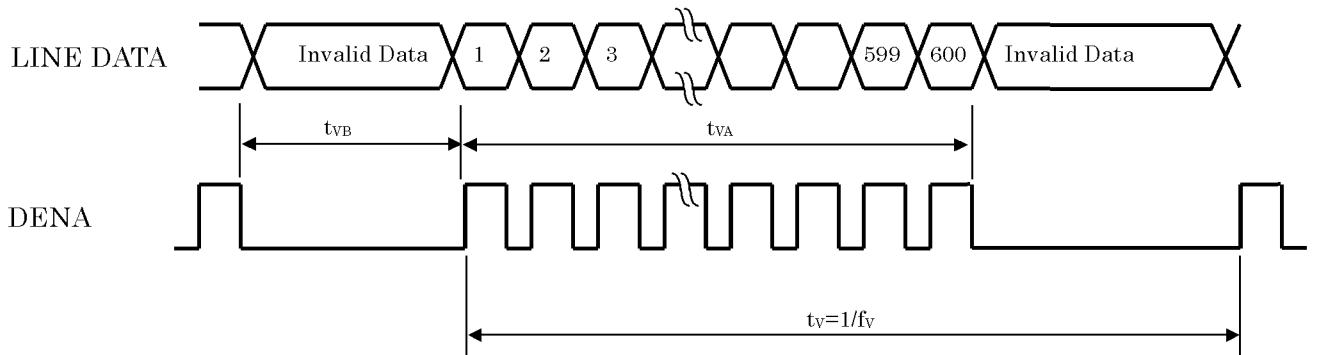

(3) Color Data Assignment

COLOR		INPUT DATA																	
		R DATA					G DATA					B DATA							
		R5	R4	R3	R2	R1	R0	G5	G4	G3	G2	G1	G0	B5	B4	B3	B2	B1	B0
		MSB					LSB	MSB					LSB	MSB					LSB
BASIC COLOR	BLACK	0	0	0	0	0	0	0	0	0	0	0	0	0	0	0	0	0	0
	RED(63)	1	1	1	1	1	1	0	0	0	0	0	0	0	0	0	0	0	0
	GREEN(63)	0	0	0	0	0	0	1	1	1	1	1	1	0	0	0	0	0	0
	BLUE(63)	0	0	0	0	0	0	0	0	0	0	0	0	1	1	1	1	1	1
	CYAN	0	0	0	0	0	0	1	1	1	1	1	1	1	1	1	1	1	1
	MAGENTA	1	1	1	1	1	1	0	0	0	0	0	0	1	1	1	1	1	1
	YELLOW	1	1	1	1	1	1	1	1	1	1	1	1	0	0	0	0	0	0
	WHITE	1	1	1	1	1	1	1	1	1	1	1	1	1	1	1	1	1	1
RED	RED(1)	0	0	0	0	0	1	0	0	0	0	0	0	0	0	0	0	0	0
	RED(2)	0	0	0	0	1	0	0	0	0	0	0	0	0	0	0	0	0	0
	RED(62)	1	1	1	1	1	0	0	0	0	0	0	0	0	0	0	0	0	0
	RED(63)	1	1	1	1	1	1	0	0	0	0	0	0	0	0	0	0	0	0
GREEN	GREEN(1)	0	0	0	0	0	0	0	0	0	0	0	1	0	0	0	0	0	0
	GREEN(2)	0	0	0	0	0	0	0	0	0	0	1	0	0	0	0	0	0	0
	GREEN(62)	0	0	0	0	0	0	1	1	1	1	1	0	0	0	0	0	0	0
	GREEN(63)	0	0	0	0	0	0	1	1	1	1	1	1	0	0	0	0	0	0
BLUE	BLUE(1)	0	0	0	0	0	0	0	0	0	0	0	0	0	0	0	0	0	1
	BLUE(2)	0	0	0	0	0	0	0	0	0	0	0	0	0	0	0	0	1	0
	BLUE(62)	0	0	0	0	0	0	0	0	0	0	0	0	1	1	1	1	1	0
	BLUE(63)	0	0	0	0	0	0	0	0	0	0	0	0	1	1	1	1	1	1

[Note]

- 1) Definition of gray scale  
 Color (n) ---n indicates gray scale level.  
 Higher n means brighter level.
- 2) Data  
 1:High, 0: Low

#### (4) Display Position and Scan Direction

D(X,Y) shows the data number of input signal for LCD panel signal processing PCB.

SC:Low

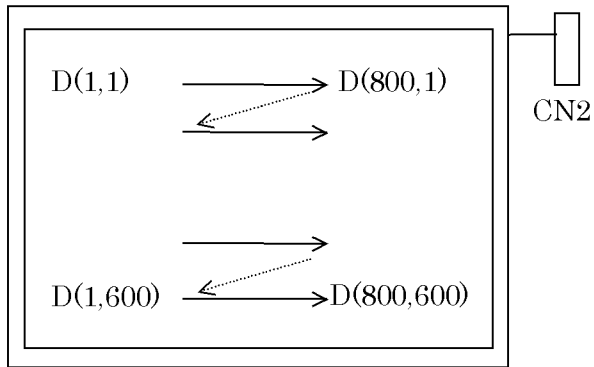

SC:High

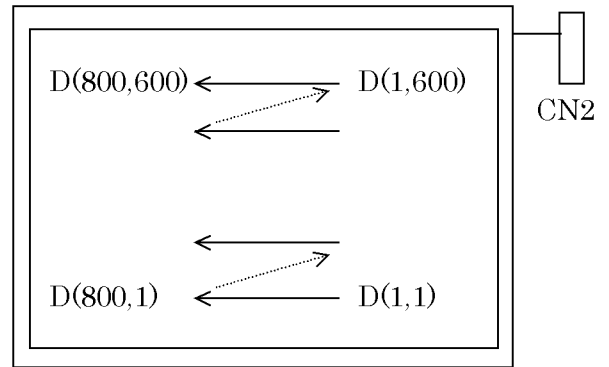

# 7. BLOCK DIAGRAM

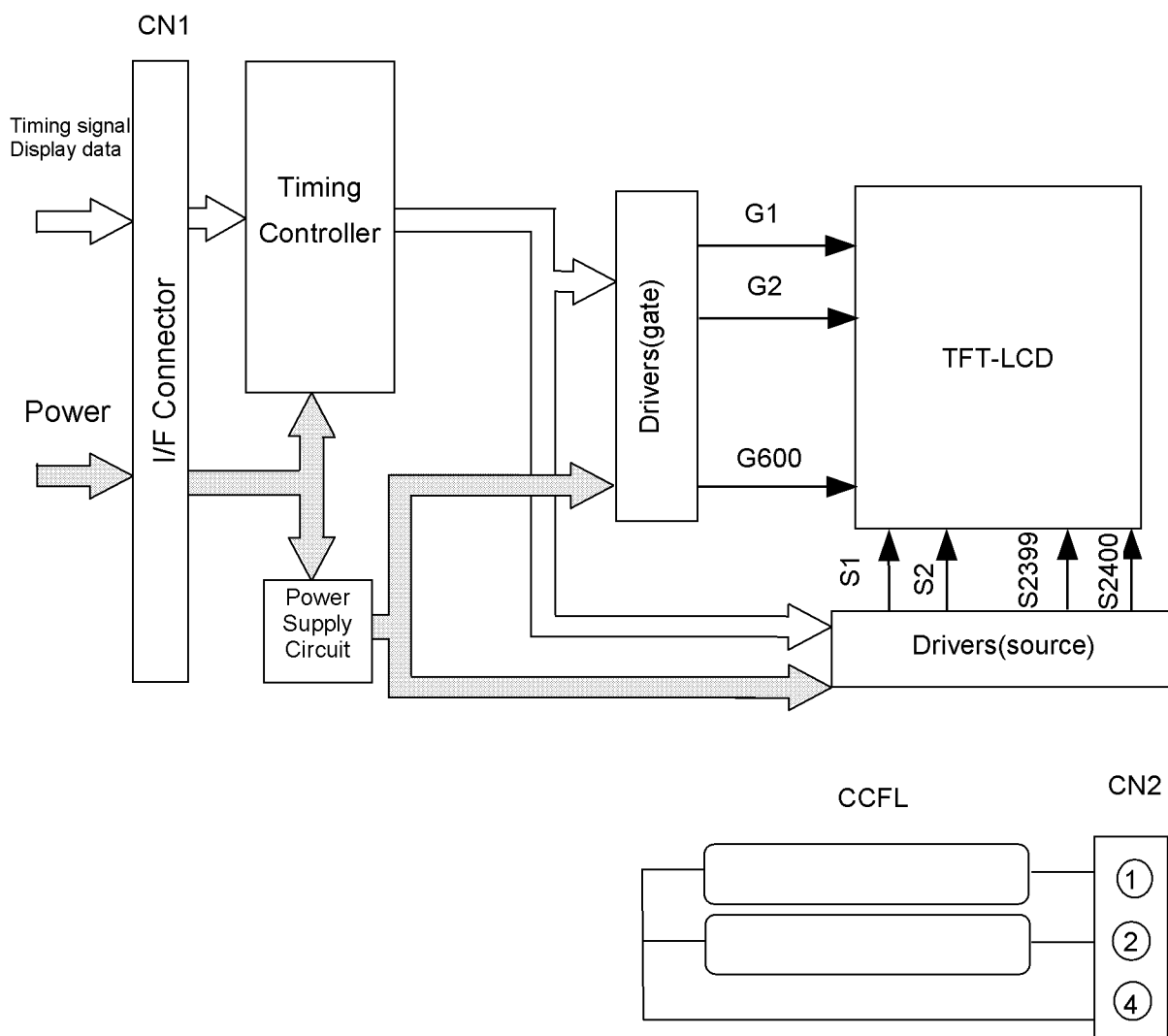

# 8. MECHANICAL SPECIFICATIONS

## (1) Front Side

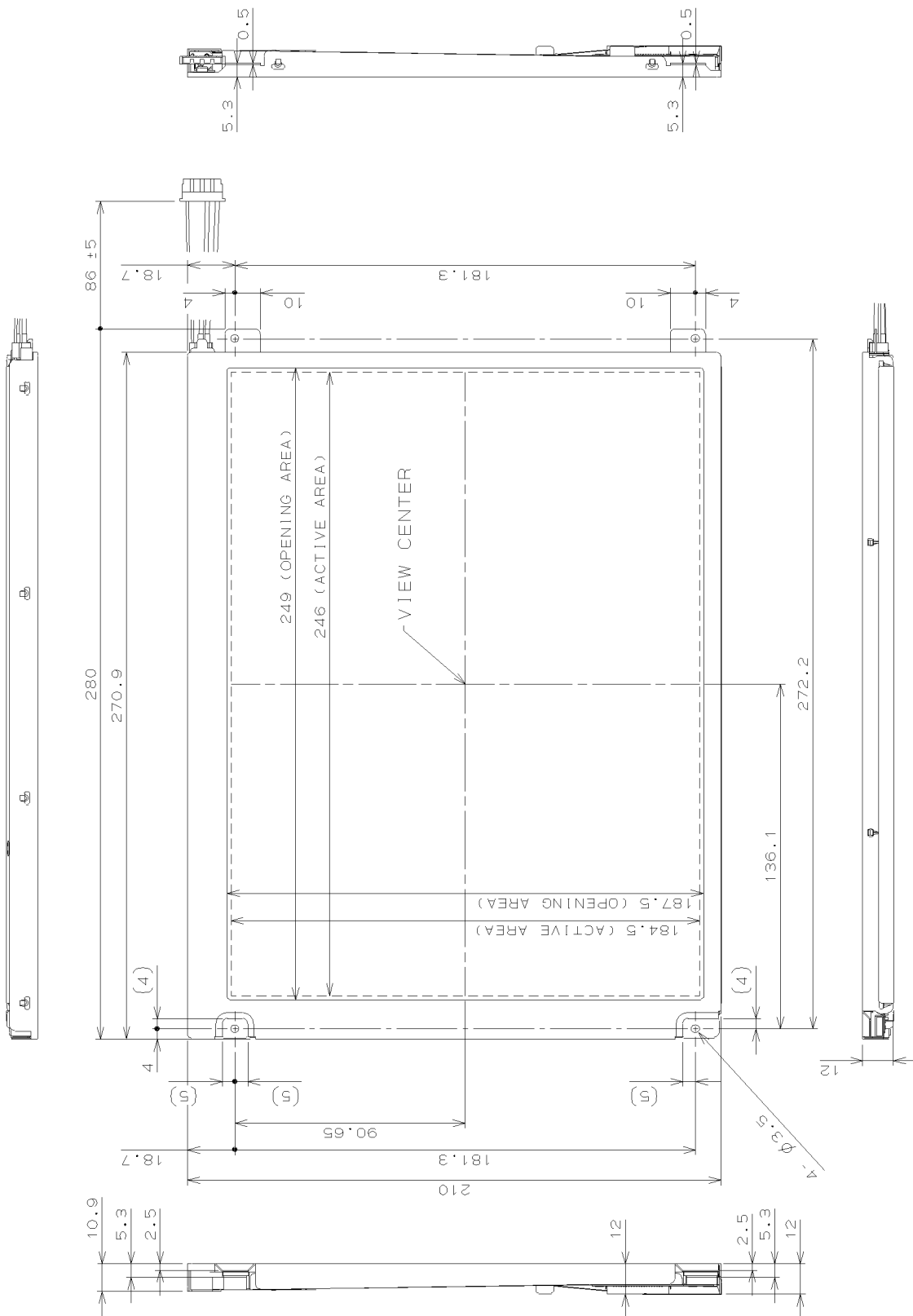

UNDEFINED TOLERANCES TO BE ±0.5mm.  
EXCEPT FOR THICKNESS OF PET FILM.

(Unit: mm)

(2) Rear Side

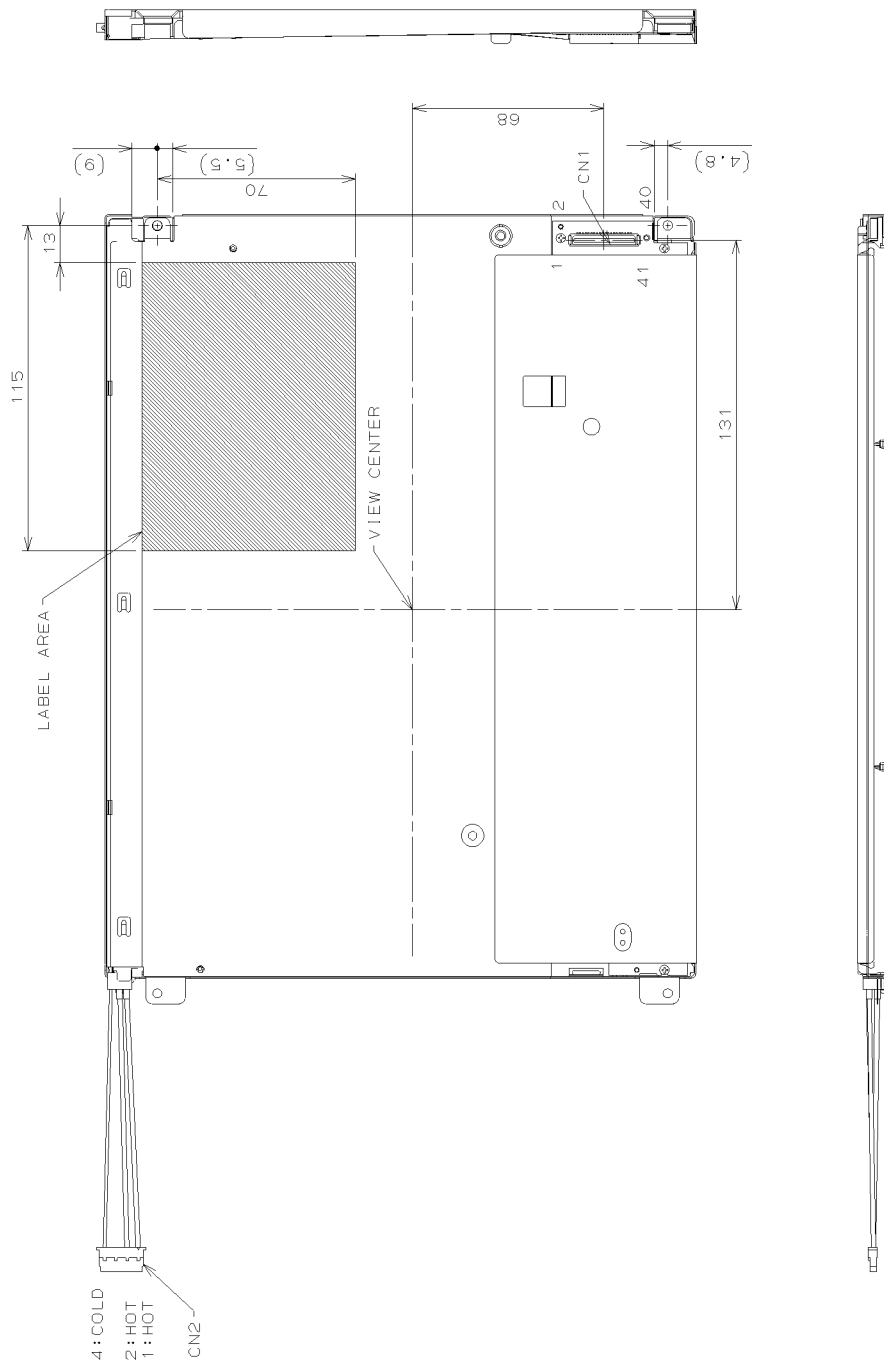

UNDEFINED TOLERANCES TO BE  $\pm 0.5\text{mm}$ .  
EXCEPT FOR THICKNESS OF PET FILM.

CN1: DF9B-41P-1V(32) (HIROSE)  
CN2: BHR-04VS-1 (JST)

(Unit:mm)

[Note]

We recommend you referring to the detailed drawing for your design.  
Please contact our company sales representative when you need the detailed drawing.

## 9. OPTICAL CHARACTERISTICS

Ta=25°C, VCC=3.3V, Input Signals: Typ. Values shown in Section 6

ITEM	SYMBOL	CONDITION	MIN	TYP	MAX	UNIT	Remarks	
Contrast Ratio	CR	$\theta_V=0^\circ, \theta_H=0^\circ$	350	500	--	--	*1)*2)*5)	
Luminance	Lw	$\theta_V=0^\circ, \theta_H=0^\circ$	250	400	--	cd/m <sup>2</sup>	*1)*5)	
Luminance Uniformity	$\Delta Lw$	$\theta_V=0^\circ, \theta_H=0^\circ$	--	--	30	%	*1)*3)*5)	
Response Time	tr	$\theta_V=0^\circ, \theta_H=0^\circ$	--	6	--	ms	*1)*4)*5)	
	tf	$\theta_V=0^\circ, \theta_H=0^\circ$	--	19	--	ms	*1)*4)*5)	
Viewing Angle	Horizontal	$\theta_H$	CR $\geq 10$	-50~50	-65~65	--	°	*1)*5)
	Vertical	$\theta_V$		-40~30	-75~45	--	°	*1)*5)
	Horizontal	$\theta_H$	CR $\geq 5$	-65~65	-80~80	--	°	*1)*5)
	Vertical	$\theta_V$		-50~40	-80~55	--	°	*1)*5)
Image sticking	tis	2 h	--	--	2	s	*6)	
Color Coordinates	Red	Rx	$\theta_V=0^\circ, \theta_H=0^\circ$	0.545	0.575	0.605	--	*1)*5)
		Ry		0.297	0.327	0.357		
	Green	Gx		0.298	0.328	0.358		
		Gy		0.501	0.531	0.561		
	Blue	Bx		0.133	0.163	0.193		
		By		0.124	0.154	0.184		
	White	Wx		0.283	0.313	0.343		
		Wy		0.299	0.329	0.359		

[Note]

These items are measured using CS1000(MINOLTA) for color coordinates, EZContrast(ELDIM) for viewing angle and CS1000 or BM-5A(TOPCON) for others under the dark room condition (no ambient light) after more than 30 minutes from turning on the lamp unless noted.

Condition: IL = 12.0 mArms, FL=55kHz

Measurement method for luminance and color coordinates is as follows.

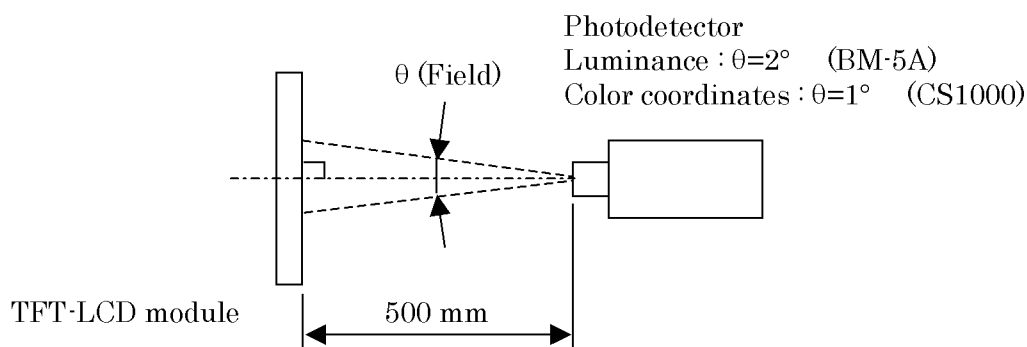

The luminance is measured according to FLAT PANEL DISPLAY MEASUREMENTS STANDARD (VESA Standard).



\*1) Measurement Point

Contrast Ratio, Luminance, Response Time, Viewing Angle, Color Coordinates: DisplayCenter  
 Luminance Uniformity: point 1~5 shown in a figure below

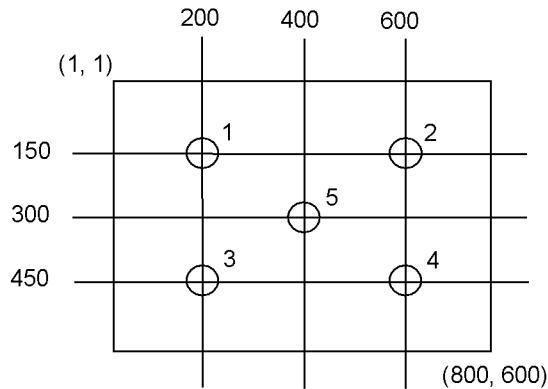

\*2) Definition of Contrast Ratio

$CR = \text{Luminance with all white pixels} / \text{Luminance with all black pixels}$

\*3) Definition of Luminance Uniformity

$\Delta Lw = [Lw(\text{MAX}) / Lw(\text{MIN}) - 1] \times 100$

\*4) Definition of Response Time

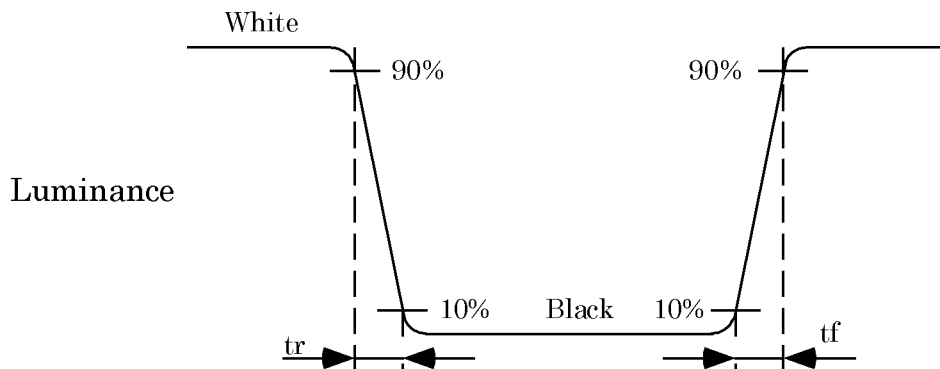

\*5) Definition of Viewing Angle( $\theta_v, \theta_H$ )

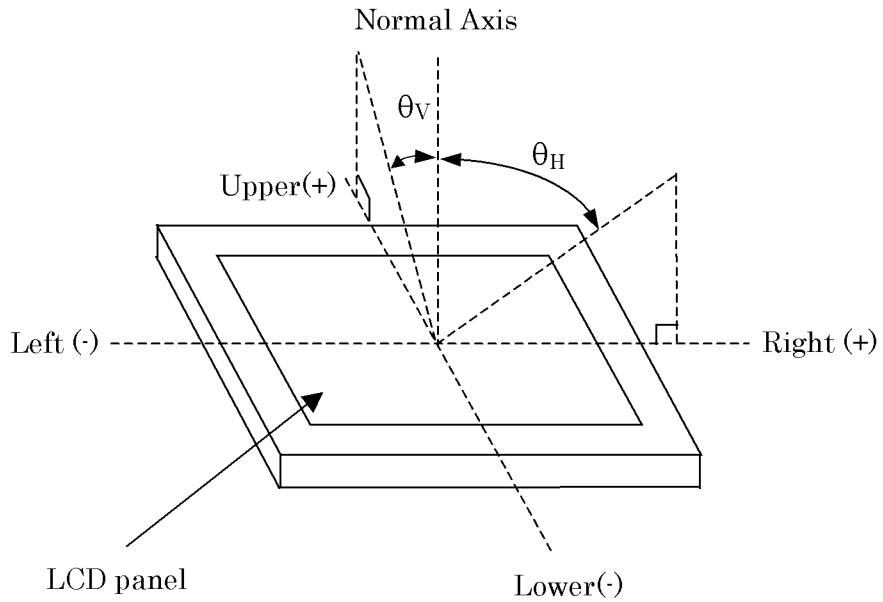

\*6) Image sticking:

Continuously display the test pattern shown in the figure below for two-hours. Then display a completely white screen. The previous image shall not persist more than two seconds at 25°C.

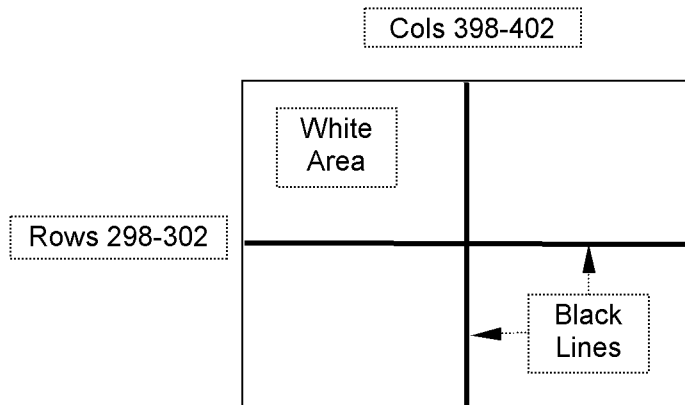

TEST PATTERN FOR IMAGE STICKING TEST

## 10. RELIABILITY TEST CONDITION

### (1) Temperature and Humidity

TEST ITEM	CONDITIONS
HIGH TEMPERATURE HIGH HUMIDITY OPERATION	40°C, 90%RH, 240 h (No condensation)
HIGH TEMPERATURE OPERATION	70°C, 240 h
LOW TEMPERATURE OPERATION	-20°C, 240 h
HIGH TEMPERATURE STORAGE	80°C, 240 h
LOW TEMPERATURE STORAGE	-20°C, 240 h
THERMAL SHOCK	BETWEEN -20°C (1h) and 80°C(1h), 100 CYCLES

### (2) Shock & Vibration

ITEM	CONDITIONS
SHOCK (NON-OPERATION)	Shock level: 1470m/s <sup>2</sup> (150G) Waveform: half sinusoidal wave, 2ms Number of shocks: one shock input in each direction of three mutually perpendicular axes for a total of six shock inputs
VIBRATION (NON-OPERATION)	Vibration level: 9.8m/s <sup>2</sup> (1.0G) Waveform: sinusoidal Frequency range: 5 to 500Hz Frequency sweep rate: 0.5 octave /min Duration: one sweep from 5 to 500 Hz in each of three mutually perpendicular axis(each x,y,z axis: 1 hour, total 3 hours)

### (3) Judgment standard

The judgment of the above tests should be made as follow:

Pass: Normal display image, no damage of the display function. (ex. no line defect)

Partial transformation of the module parts should be ignored.

Fail: No display image, damage of the display function. (ex. line defect)

## 12. OTHER FEATURE

This LCD module complies with RoHS. \*)

\*) RoHS: Restriction of the use of certain hazardous substances in electrical and electronic equipment