

# 2557

## PROTECTED QUAD LOW-SIDE DRIVER WITH FAULT DETECTION and SLEEP MODE

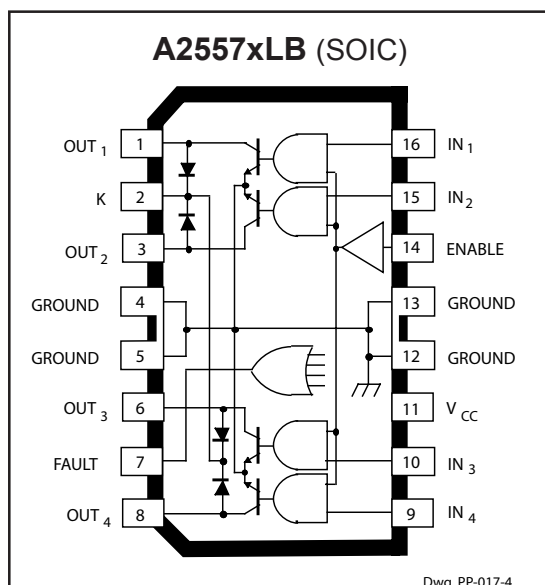

Note that the A2557xB (DIP) and the A2557xLB (SOIC) are electrically identical and share a common terminal number assignment.

### ABSOLUTE MAXIMUM RATINGS

Output Voltage, $V_O$ .....	60 V
Over-Current Protected Output Voltage, $V_O$ .....	32 V
Output Current, $I_O$ .....	500 mA*
FAULT Output Voltage, $V_{FLT}$ .....	60 V
Logic Supply Voltage, $V_{CC}$ .....	7.0 V
Input Voltage, $V_I$ or $V_{OE}$ .....	7.0 V
Package Power Dissipation, $P_D$ .....	See Graph
Operating Temperature Range, $T_A$	
Suffix 'S-' .....	-20°C to +85°C
Suffix 'E-' .....	-40°C to +85°C
Suffix 'K-' .....	-40°C to +125°C
Junction Temperature, $T_J$ .....	+150°C*
Storage Temperature Range, $T_S$ .....	-55°C to +150°C

\*Outputs are current limited at approximately 500 mA per driver and junction temperature limited if higher current is attempted.

The A2557xB, A2557xEB, and A2557xLB have been specifically designed to provide cost-effective solutions to relay-driving applications with up to 300 mA drive current per channel. They may also be used for driving incandescent lamps in applications where turn-on time is not a concern. Each of the four outputs will sink 300 mA in the on state. The outputs have a minimum breakdown voltage of 60 V and a sustaining voltage of 40 V. A low-power Sleep Mode is activated with either ENABLE low or all inputs low. In this mode, the supply current drops to below 100  $\mu$ A.

Over-current protection for each channel has been designed into these devices and is activated at a nominal 500 mA. It protects each output from short circuits with supply voltages up to 32 V. When an output experiences a short circuit, the output current is limited at the 500 mA current clamp. In addition, foldback circuitry decreases the current limit if an excessive voltage is present across the output and assists in keeping the device within its SOA (safe operating area). An exclusive-OR circuit compares the input and output state of each driver. If either a short or open load condition is detected, a single FAULT output is turned on (active low).

Continuous or multiple overload conditions causing the channel temperature to reach approximately 165°C will result in an additional linear decrease in the output current of the affected driver. If the fault condition is corrected, the output stage will return to its normal saturated condition.

The packages offer fused leads for enhanced thermal dissipation. Package B is 16-pin power DIP with exposed tabs, EB is 28-lead power PLCCs, and LB are 16-lead power wide-body SOICs for surface-mount applications. The lead (Pb) free versions have 100% matte tin leadframe plating.

### FEATURES

- 300 mA Output Current per Channel
- Independent Over-Current Protection & Thermal Limiting for Each Driver
- Output Voltage to 60 V
- Output SOA Protection
- Fault-Detection Circuitry for Open or Shorted Load
- Low Quiescent Current Sleep Mode
- Integral Output Flyback/Clamp Diodes
- TTL- and 5 V CMOS-Compatible Inputs

**2557**  
**PROTECTED QUAD DRIVER**  
**WITH FAULT DETECTION**  
**& SLEEP MODE**

**Selection Guide**

<b>Part Number</b>	<b>Pb-free</b>	<b>Package</b>	<b>Ambient Temperature (°C)</b>
A2557SB	–	16-pin DIP, exposed tabs	–20 to 85
A2557SB-T	Yes	16-pin DIP, exposed tabs	–20 to 85
A2557SEB	–	28-lead PLCC	–20 to 85
A2557SEB-T	Yes	28-lead PLCC	–20 to 85
A2557SLB	–	16-lead SOIC	–20 to 85
A2557SLB-T	Yes	16-lead SOIC	–20 to 85
A2557EB	–	16-pin DIP, exposed tabs	–40 to 85
A2557EB-T	Yes	16-pin DIP, exposed tabs	–40 to 85
A2557EEB	–	28-lead PLCC	–40 to 85
A2557EEB-T	Yes	28-lead PLCC	–40 to 85
A2557ELB	–	16-lead SOIC	–40 to 85
A2557ELB-T	Yes	16-lead SOIC	–40 to 85
A2557KB	–	16-pin DIP, exposed tabs	–40 to 125
A2557KB-T	Yes	16-pin DIP, exposed tabs	–40 to 125
A2557KEB	–	28-lead PLCC	–40 to 125
A2557KEB-T	Yes	28-lead PLCC	–40 to 125
A2557KLB	–	16-lead SOIC	–40 to 125
A2557KLB-T	Yes	16-lead SOIC	–40 to 125

# 2557 PROTECTED QUAD DRIVER WITH FAULT DETECTION & SLEEP MODE

## FUNCTIONAL BLOCK DIAGRAM

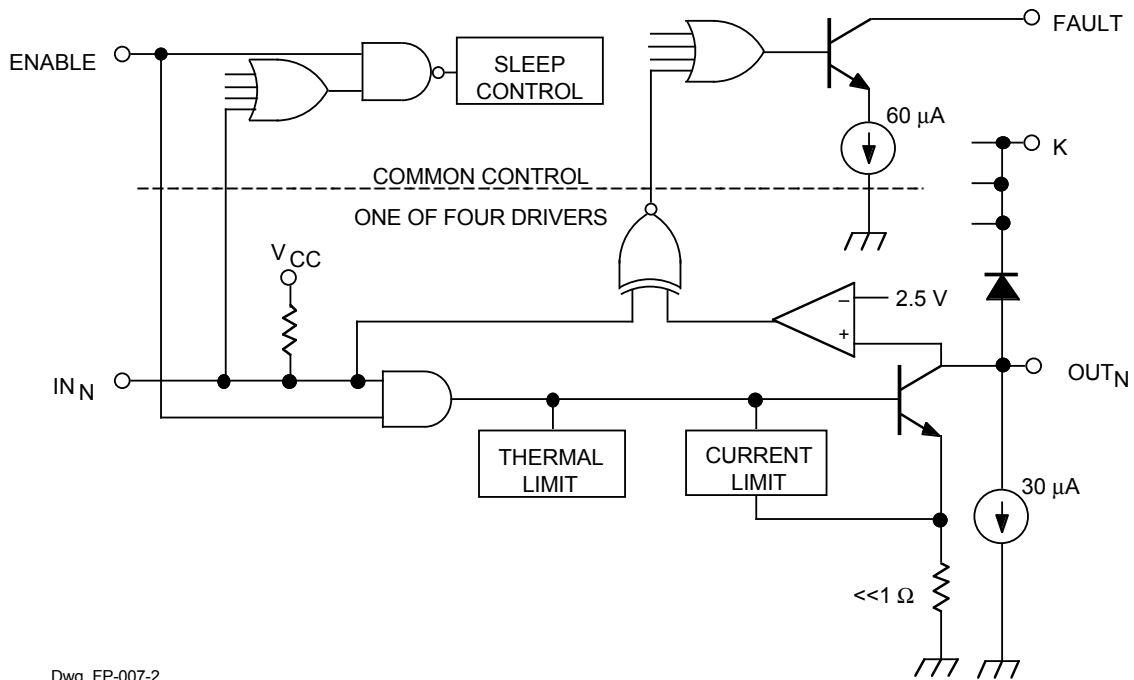

Dwg. FP-007-2

**A2557xEB (PLCC)**

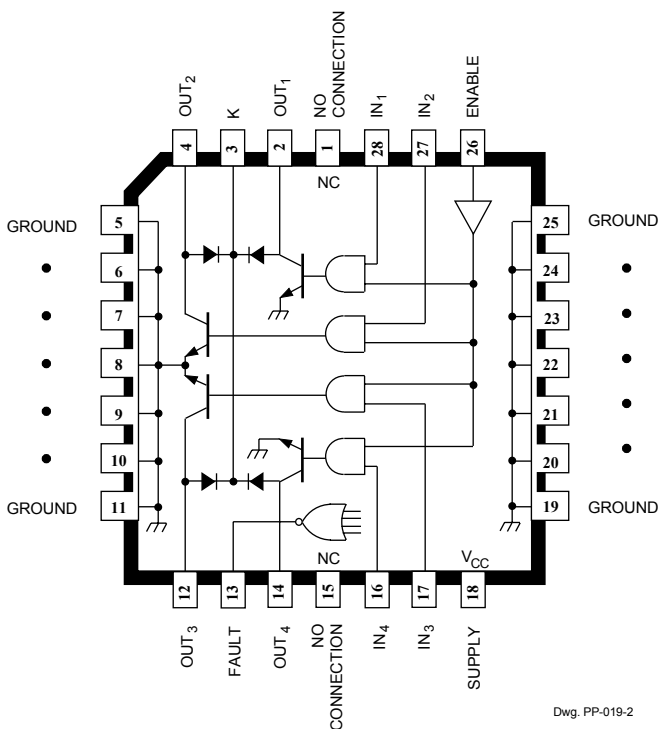

Dwg. PP-019-2

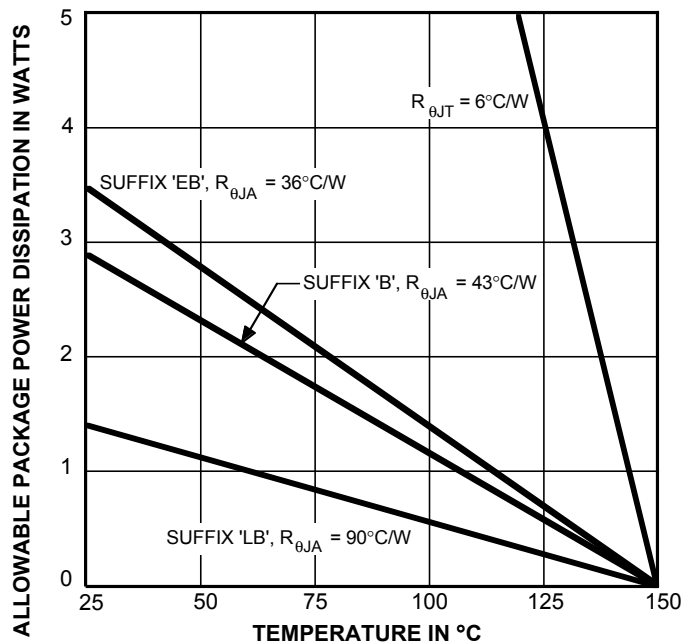

Dwg. GP-004-2B

**2557**  
**PROTECTED QUAD DRIVER**  
**WITH FAULT DETECTION**  
**& SLEEP MODE**

**ELECTRICAL CHARACTERISTICS** over operating temperature range,  $V_{CC} = 4.75\text{ V}$  to  $5.25\text{ V}$

Characteristic	Symbol	Test Conditions	Limits			Units
			Min.	Typ.	Max.	
Output Leakage Current*	$I_{CEX}$	$V_O = 60\text{ V}$ , $V_I = 0.8\text{ V}$ , $V_{OE} = 2.0\text{ V}$	—	30	100	$\mu\text{A}$
		$V_O = 60\text{ V}$ , $V_I = 2.0\text{ V}$ , $V_{OE} = 0.8\text{ V}$	—	<1.0	100	$\mu\text{A}$
Output Sustaining Voltage	$V_{O(SUS)}$	$I_O = 100\text{ mA}$ , $V_I = V_{OE} = 0.8\text{ V}$ , $V_{CC} = \text{Open}$	40	—	—	V
Output Saturation Voltage	$V_{O(SAT)}$	$I_O = 100\text{ mA}$	—	65	200	mV
		$I_O = 300\text{ mA}$	—	180	300	mV
Over-Current Limit	$I_{OM}$	5 ms PulseTest, $V_O = 5.0\text{ V}$	—	500	—	mA
Input Voltage	$V_{IH}$	$IN_n$ or ENABLE	2.0	—	—	V
	$V_{IL}$	$IN_n$ or ENABLE	—	—	0.8	V
Input Current	$I_{IH}$	$IN_n$ or ENABLE, $V_{IH} = 2.0\text{ V}$	—	—	10	$\mu\text{A}$
	$I_{IL}$	$IN_n$ or ENABLE, $V_{IL} = 0.8\text{ V}$	—	—	-10	$\mu\text{A}$
Fault Output Leakage Current	$I_{FLT}$	$V_{FLT} = 60\text{ V}$	—	4.0	15	$\mu\text{A}$
		$V_{FLT} = 5\text{ V}$	—	<1.0	2.0	$\mu\text{A}$
Fault Output Current	$I_{FLT}$	$V_{FLT} = 5\text{ V}$ , Driver Output Open, $V_I = 0.8\text{ V}$ , $V_{OE} = 2.0\text{ V}$	40	60	80	$\mu\text{A}$
Fault Output Saturation Voltage	$V_{FLT(SAT)}$	$I_{FLT} = 30\text{ }\mu\text{A}$	—	0.1	0.4	V
Clamp Diode Forward Voltage	$V_F$	$I_F = 500\text{ mA}$	—	1.2	1.7	V
		$I_F = 750\text{ mA}$	—	1.5	2.1	V
Clamp Diode Leakage Current	$I_R$	$V_R = 60\text{ V}$	—	—	50	$\mu\text{A}$
Turn-On Delay	$t_{PHL}$	$I_O = 300\text{ mA}$ , 50% $V_I$ to 50% $V_O$	—	0.6	10	$\mu\text{s}$
		From Sleep, $I_O = 300\text{ mA}$ , 50% $V_I$ to 50% $V_O$	—	3.0	—	$\mu\text{s}$
		$I_O = 300\text{ mA}$ , 50% $V_{OE}$ to 50% $V_O$	—	1.3	10	$\mu\text{s}$
Turn-Off Delay	$t_{PLH}$	$I_O = 300\text{ mA}$ , 50% $V_I$ to 50% $V_O$	—	2.0	10	$\mu\text{s}$
		$I_O = 300\text{ mA}$ , 50% $V_{OE}$ to 50% $V_O$	—	1.4	10	$\mu\text{s}$
Total Supply Current	$I_{CC}$	All Outputs Off	—	0.075	0.1	mA
		Any One Output On	—	12	20	mA
		Two Outputs On	—	18	30	mA
		Three Outputs On	—	24	40	mA
		All Outputs On	—	30	50	mA
Thermal Limit	$T_J$		—	165	—	$^{\circ}\text{C}$

Typical Data is at  $T_A = +25^{\circ}\text{C}$  and  $V_{CC} = 5\text{ V}$  and is for design information only.

Negative current is defined as coming out of (sourcing) the specified terminal.

As used here, -100 is defined as greater than +10 (absolute magnitude convention) and the minimum is implicitly zero.

\* Measurement includes output fault-sensing pull-down current.

# 2557 PROTECTED QUAD DRIVER WITH FAULT DETECTION & SLEEP MODE

## TYPICAL OPERATING CHARACTERISTICS

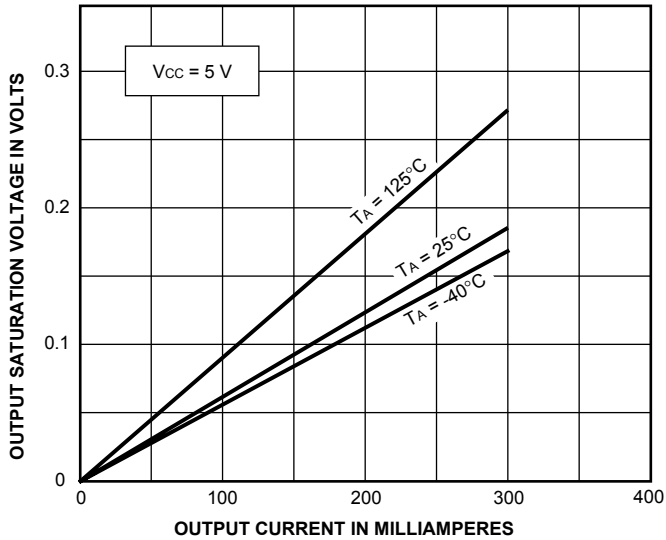

Dwg. GP-064

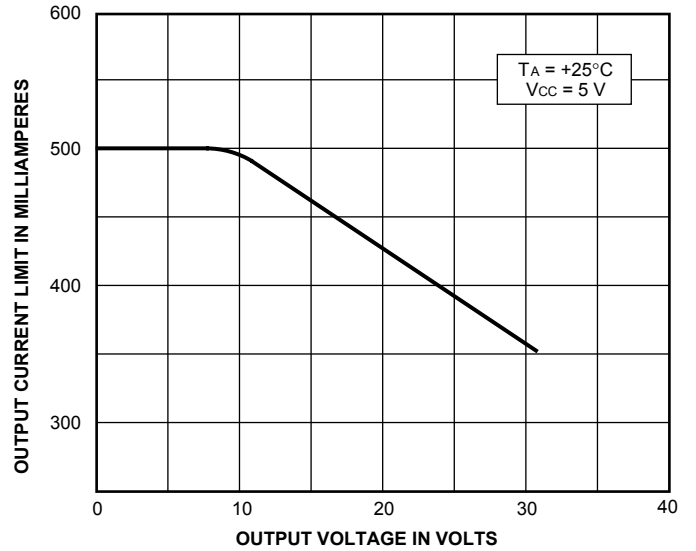

Dwg. GP-065

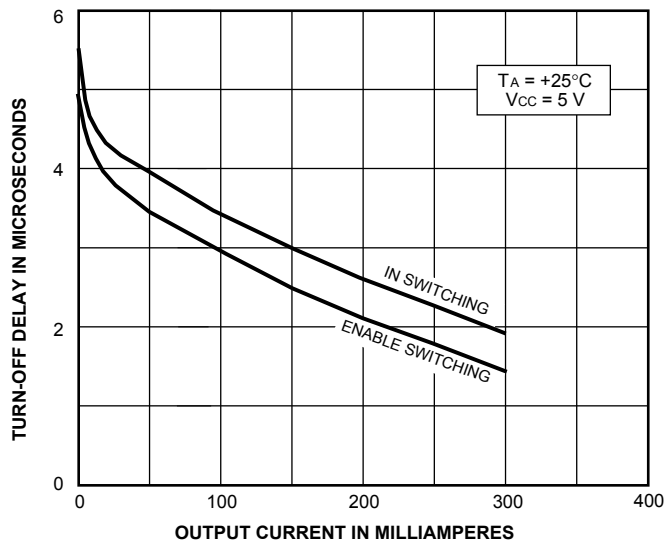

Dwg. GP-066

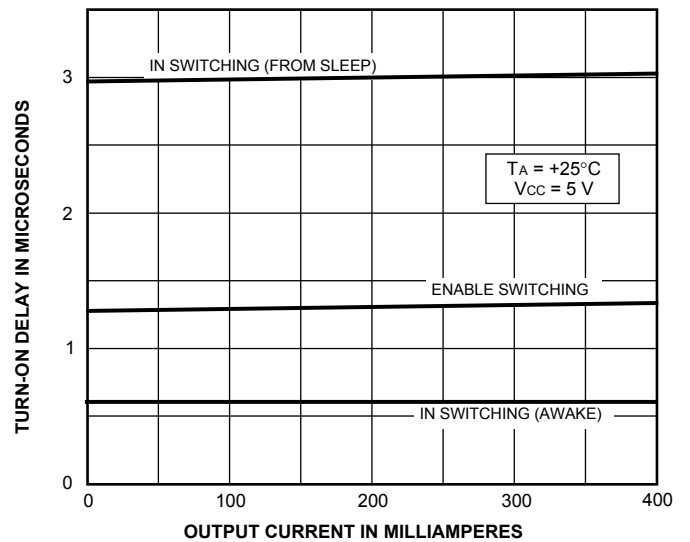

Dwg. GP-066-1

# 2557 PROTECTED QUAD DRIVER WITH FAULT DETECTION & SLEEP MODE

## CIRCUIT DESCRIPTION AND APPLICATION

The A2557 low-current quad power drivers provide protected output driver functions, combined with a fault diagnostic scheme, plus an automatic low-current Sleep-Mode function. These devices monitor their outputs for fault (open or shorted) conditions. For each channel the input and output levels are compared. If these are different from the expected levels then a fault condition is flagged by pulling the common FAULT output low.

Status	IN <sub>N</sub>	ENABLE	OUT <sub>N</sub>	FAULT
Normal Load	H	H	L	H
	L	H	H	H
Sleep Mode	X	L	H	H
	All L	X	H	H
Over-Current or Short to Supply	H	H	R	L
Open Load or Short to Ground	L	H	L	L
Thermal Fault	H	H	H	L
R = Linear drive, current limited.				

The FAULT output is operational only if ENABLE is high. The output state is detected by monitoring the OUT<sub>n</sub> terminal using a comparator whose threshold is typically 2.5 V. In order to detect open-circuit outputs, a 30  $\mu$ A current sink pulls the output below the comparator threshold. To ensure correct fault operation, a minimum load of approximately 1 mA is required. The fault function is disabled when in 'sleep' mode, i.e., FAULT goes high and the 30  $\mu$ A output sinks are turned off. The FAULT output is a switched current sink of typically 60  $\mu$ A.

Each channel consists of a TTL/CMOS-compatible logic input gated with a common ENABLE input. A logic high at the input will provide drive to turn on the output npn switch. Each output has a current-limit circuit that limits the output current by detecting the voltage drop across a low-value internal resistor in the emitter of the output switch. If this drop reaches a threshold, then the base drive to the output switch is reduced to maintain constant current in the output.

To keep the device within its safe operating area (SOA) this output current limit is further reduced

- if the power dissipation in the output device increases the local junction temperature above 165°C (nominal), so as to limit the power dissipation (and hence the local junction temperature). As each channel has its own thermal limit circuitry this provides some independence between the output channels, i.e., one channel can be operating in thermally reduced current limit, while the others can provide full drive capability.
- as a function of the output voltage. Full current limit of 500 mA (nominal) is available up to approximately V<sub>O</sub> = 8 V; above this the limit is reduced linearly to about 350 mA at V<sub>O</sub> = 32 V. This helps to improve SOA by immediately reducing the peak power pulse into a shorted load at high V<sub>O</sub>.

A logic low at the ENABLE input causes all outputs to be switched off regardless of the state of the IN terminals. In addition, the device is put into a low quiescent current 'sleep' mode, reducing I<sub>CC</sub> below 100  $\mu$ A. If ENABLE is taken high and any of the inputs go high, the circuit will 'auto-wake-up'. However, if the device is enabled, but all inputs stay low, then the circuit remains in 'sleep' mode.

All outputs have internal flyback diodes, with a common-cathode connection at the K terminal.

### Incandescent lamp driver

High incandescent lamp turn-on (in-rush currents) can contribute to poor lamp reliability and destroy semiconductor lamp drivers. When an incandescent lamp is initially turned on, the cold filament is at minimum resistance and would normally allow a 10x to 12x in-rush current.

Warming (parallel) or current-limiting (series) resistors protect both driver and lamp but use significant power either when the lamp is off or when the lamp is on, respectively. Lamps with steady-state current ratings up to 300 mA can be driven without the need for warming or current-limiting resistors, if lamp turn-on time is not a concern (10s of ms).

With these drivers, during turn-on, the high in-rush current is sensed by the internal sense resistor, drive current to the output stage is reduced, and the output operates in a linear mode with the load current limited to approximately 500 mA. During lamp warmup, the filament resistance increases to its maximum value, the output driver goes into saturation and applies maximum rated voltage to the lamp.

# 2557 PROTECTED QUAD DRIVER WITH FAULT DETECTION & SLEEP MODE

## CIRCUIT DESCRIPTION AND APPLICATION (continued)

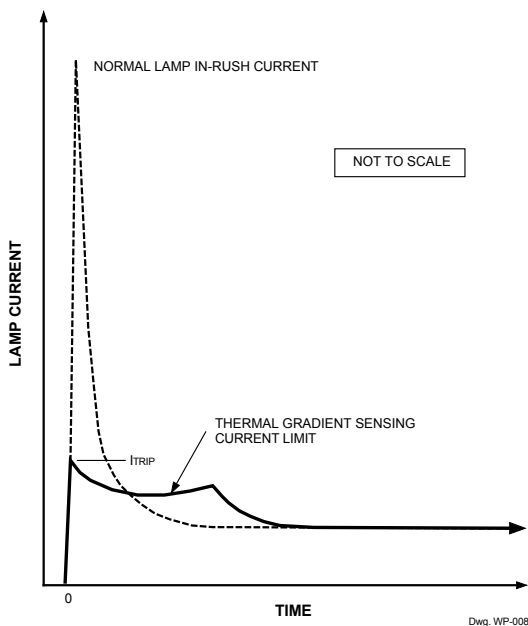

### Inductive load driver

Bifilar (unipolar) stepper motors (and other inductive loads) can be driven directly. The internal diodes prevent damage to the output transistors by suppressing the high-voltage spikes that occur when turning off an inductive load. For rapid current decay (fast turn-off speeds), the use of Zener diodes will raise the flyback voltage and improve performance. However, the peak voltage must not exceed the specified minimum sustaining voltage ( $V_{\text{SUPPLY}} + V_Z + V_F < V_{\text{O(SUS)}}$ ).

### Over-current conditions

In the event of a shorted load, or stalled motor, the load current will attempt to increase. As described above, the drive current to the affected output stage is linearly reduced, causing the output to go linear (limiting the load current to about 500 mA). As the junction temperature of the output stage increases, the thermal-shutdown circuit will shut off the affected output. If the fault condition is corrected, the output driver will return to its normal saturated condition.

### Fault diagnostics

A pull-up resistor or current source is required on the FAULT output. This can be connected to whatever supply level the following circuitry requires (within the specification constraints). For a 5 V supply (i.e.,  $V_{\text{CC}}$ ) 150 k $\Omega$  or greater should be used. As the fault diagnostic function is to indicate when the output state is different from the input state for any channel, the FAULT output waveform will obviously produce a pulse waveform following the combined duty-cycle of all channels showing a fault condition. There are therefore two basic approaches to using the function in an application:

- As an interrupt in a controller-based system. If the system has a microcontroller then a FAULT low causes an interrupt, which then initiates a diagnostic sequence to find the culprit channel. This sequence usually consists of cycling through each channel one at a time, while monitoring the FAULT output. It is then easy to determine which channel has the faulty output and how it is failing (i.e., short to supply, open-circuit or short to ground). The system may then take whatever action is required, but could continue with operation of the remaining 'good' channels while disabling signals to the faulty channel.
- As a simple 'common' fault indication. If there is no controller in the system then the FAULT output can be set to give an indication (via a lamp or LED, etc.) of a fault condition which might be anywhere on the four channels. Because the FAULT output is dependent on the states of the input and output (four possibilities) but will only indicate on two of them, the duty cycle at the FAULT output will reflect the duty cycle at the faulty channel's input (or its inverse, depending upon fault type).

In typical applications (50% duty cycles) a simple solution is to make the pull-up current on the FAULT output much less than the pull-down current (60  $\mu\text{A}$ ), and add a capacitor to give a time constant longer than the period of operation. For typical values, the device will produce a continuous dc output level. Component values will need to be adjusted to cope with different conditions.

# 2557 PROTECTED QUAD DRIVER WITH FAULT DETECTION & SLEEP MODE

## CIRCUIT DESCRIPTION AND APPLICATION (continued)

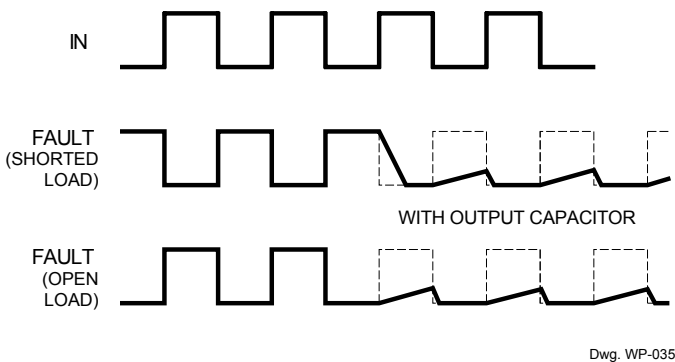

Under some conditions it is possible to get spurious glitches on the FAULT output at load turn-on and turn-off transitions:

- **Light load turn-off.** Under light loading conditions the turn-off delay (see characteristics above) of the output stage increases and may result in a spurious fault output of a few  $\mu\text{s}$  (the duration being proportional to the turn-off delay). As it is difficult to define this over all operating conditions, if a particular application would be sensitive to this type of glitch, then it is generally recommended to include a small (about  $0.01 \mu\text{F}$ ) smoothing/storage capacitor at the FAULT output.
- **Incandescent lamp turn-on.** As described above, driving an incandescent filament results in the driver operating in current limit for a period after turn-on. During this period a “fault” condition will be indicated (over current). As discussed above this period can be 10s of ms. To avoid this indication, the capacitor on the FAULT output would need to be increased to provide an appropriate time constant. Alternatively, in a microcontroller-based system, the code could be written to ignore the FAULT condition for an appropriate period after lamp turn on.

Correct FAULT operation cannot be guaranteed with an unconnected output — unused outputs should not be turned on, *or* unused outputs should be pulled high to  $>2.5 \text{ V}$ , *and/or* associated inputs tied low.

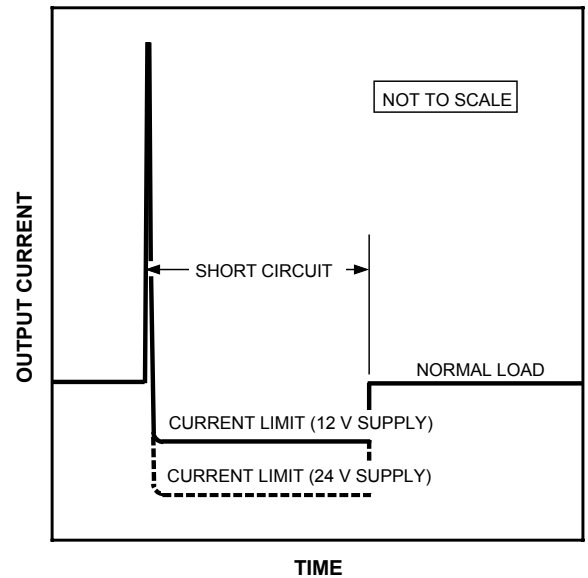

### Thermal considerations

Device power dissipation can be calculated as:

$$P_D = (V_{O1} \times I_{O1} \times \text{duty cycle}_1) + \dots + (V_{O4} \times I_{O4} \times \text{duty cycle}_4) + (V_{CC} \times I_{CC})$$

Note -  $I_{CC}$  is also modulated by the duty cycle, but this is a reasonable approximation for most purposes.

This can then be compared against the permitted package power dissipation, using:

$$\text{Permitted } P_D = (150 - T_A) / R_{\theta JA}$$

where  $R_{\theta JA}$  is given as:

- 28-lead PLCC (part number suffix ‘-EB’) =  $36^\circ\text{C/W}$
- 16-pin PDIP (part number suffix ‘-B’) =  $43^\circ\text{C/W}$
- 16-lead SOIC (part number suffix ‘-LB’) =  $90^\circ\text{C/W}$

$R_{\theta JA}$  is measured on typical two-sided PCB. Additional information is available on the Allegro web site.



# 2557 PROTECTED QUAD DRIVER WITH FAULT DETECTION & SLEEP MODE

## B Package, 16-pin DIP with internally fused pins 4, 5, 12, and 13 and external thermal tabs

Preliminary dimensions, for reference only  
 Dimensions in inches  
 Metric dimensions (mm) in brackets, for reference only  
 (reference JEDEC MS-001 BB)  
 Dimensions exclusive of mold flash, gate burrs, and dambar protrusions  
 Exact case and lead configuration at supplier discretion within limits shown

 Terminal #1 mark area

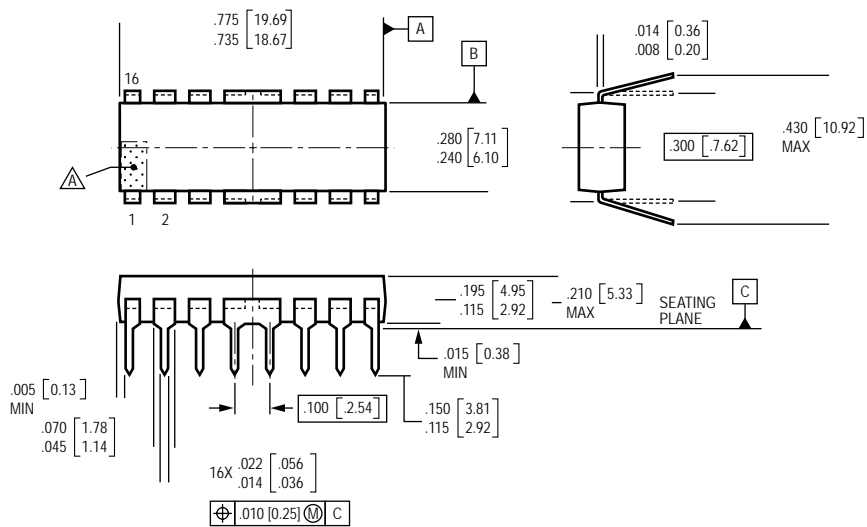

# 2557 PROTECTED QUAD DRIVER WITH FAULT DETECTION & SLEEP MODE

## EB Package, 28-pin PLCC with internally fused pins 5 through 11 and 19 through 25

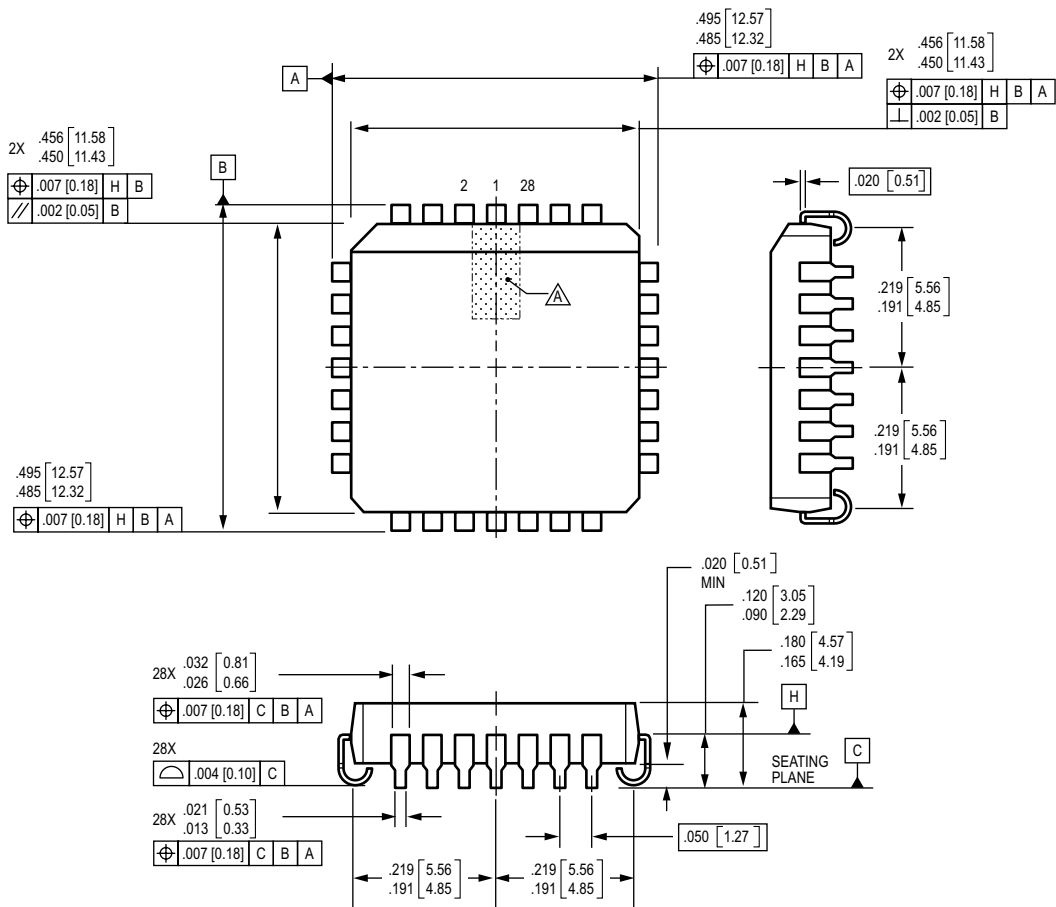

Preliminary dimensions, for reference only  
(reference JEDEC MS-018 AB)  
Dimensions in inches  
Millimeters (mm) in brackets, for reference only  
Dimensions exclusive of mold flash, gate burrs, and dambar protrusions  
Exact case and lead configuration at supplier discretion within limits shown  
△ Terminal #1 mark area

# 2557 PROTECTED QUAD DRIVER WITH FAULT DETECTION & SLEEP MODE

## LB Package, 16-pin SOIC with internally fused pins 4 and 5, and 12 and 13

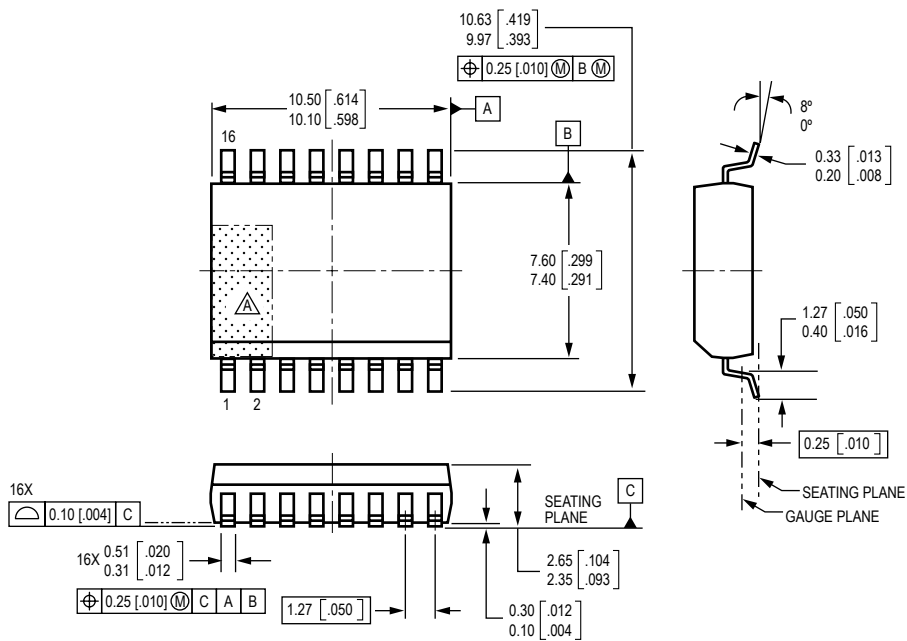

Preliminary dimensions, for reference only  
 Dimensions in millimeters  
 U.S. Customary dimensions (in.) in brackets, for reference only  
 (reference JEDEC MS-013 AA)  
 Dimensions exclusive of mold flash, gate burrs, and dambar protrusions  
 Exact case and lead configuration at supplier discretion within limits shown  
 ⚠ Terminal #1 mark area

**2557**  
**PROTECTED QUAD DRIVER**  
**WITH FAULT DETECTION**  
**& SLEEP MODE**

*The products described here are manufactured under one or more U.S. patents or U.S. patents pending.*

*Allegro MicroSystems, Inc. reserves the right to make, from time to time, such departures from the detail specifications as may be required to permit improvements in the performance, reliability, or manufacturability of its products. Before placing an order, the user is cautioned to verify that the information being relied upon is current.*

*Allegro products are not authorized for use as critical components in life-support devices or systems without express written approval.*

*The information included herein is believed to be accurate and reliable. However, Allegro MicroSystems, Inc. assumes no responsibility for its use; nor for any infringement of patents or other rights of third parties which may result from its use.*