

# LG240641-DW 240 x 64 dots + white led backlight

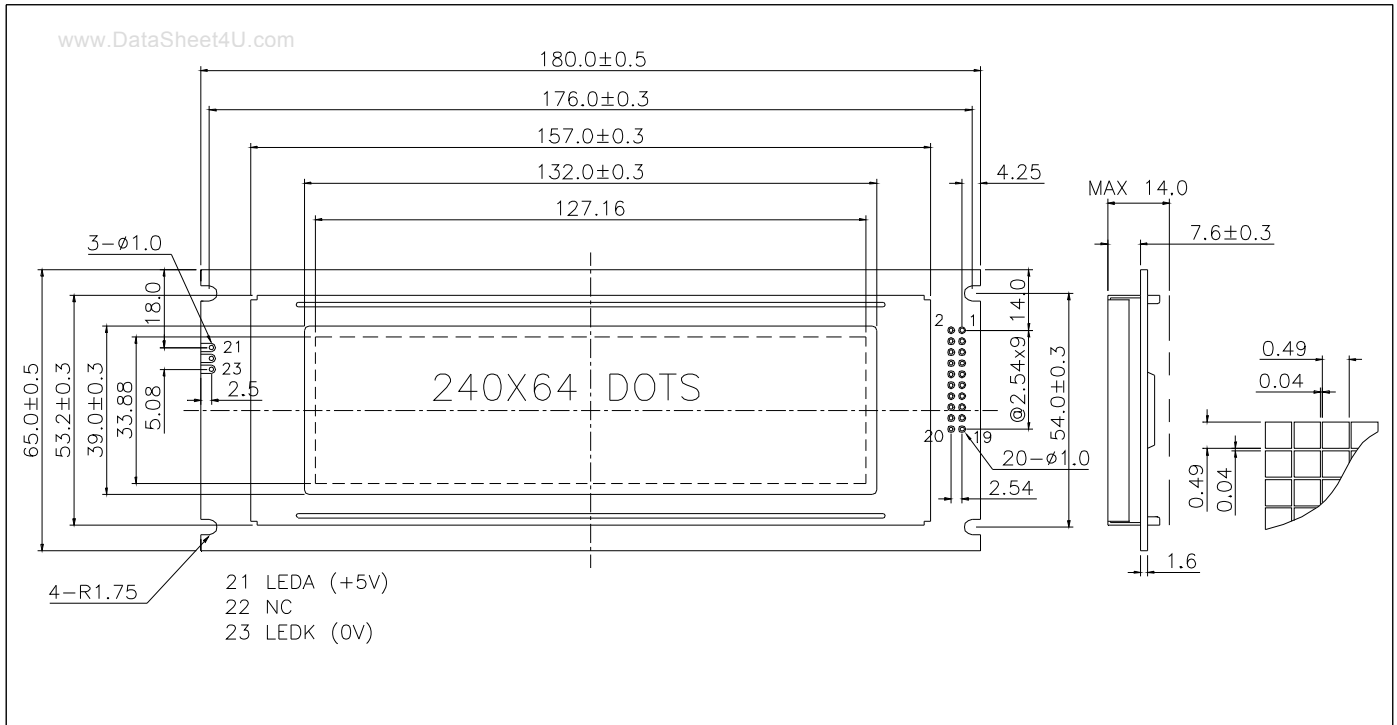

## ABSOLUTE MAXIMUM RATINGS

Item	Symbol	Min.	Max.	Unit
Supply Voltage(Logic)	V <sub>DD</sub> - V <sub>SS</sub>	-0.3	7.0	V
Supply Voltage(LCD)	V <sub>DD</sub> - V <sub>O</sub>	-0.3	25.0	V
Input Voltage	V <sub>I</sub>	-0.3	V <sub>DD</sub> + 0.3	V
Operating Temp.	T <sub>opr</sub>	-20	70	°C
Storage Temp.	T <sub>stg</sub>	-30	80	°C

## MECHANICAL DATA

Item	Nominal Dimensions	Unit
Module Size ( W x H x T )	180.0 x 65.0 x 14.0	mm
Viewing Area ( W x H )	132.0 x 39.0	mm
Dot Pitch ( W x H )	0.53 x 0.53	mm
Dot Size ( W x H )	0.49 x 0.49	mm
Weight	Approx. 150	g

## ELECTRICAL CHARACTERISTICS ( V<sub>DD</sub>=5V±0.25V )

Item	Symbol	Test Condition	Min.	Typ.	Max.	Unit
Input High Voltage	V <sub>IH</sub>	--	V <sub>DD</sub> -2.2	--	V <sub>DD</sub>	V
Input Low Voltage	V <sub>IL</sub>	--	- 0.3	--	0.8	V
Output High Voltage	V <sub>OH</sub>	--	V <sub>DD</sub> -0.3	--	V <sub>DD</sub>	V
Output Low Voltage	V <sub>OL</sub>	--	0	--	0.3	V
Supply Current	I <sub>DD</sub>	V <sub>DD</sub> = 5.0V	--	16.0	20.0	mA
LCD Driving Voltage	V <sub>DD</sub> - V <sub>O</sub>	T <sub>a</sub> =25°C	--	12.7	--	V

## PIN CONNECTIONS

Pin	Symbol	Level	Function
1	FG	--	Frame ground
2	V <sub>SS</sub>	0V	GND
3	V <sub>DD</sub>	+5V	Power supply for logic
4	V <sub>O</sub>	--	Operating voltage for LCD
5	/WR	L	Write signal, active "L"
6	/RD	L	Read signal, active "L"
7	/CE	L	Chip enable signal, active "L"
8	C/D	H/L	L : Data H : Instruction code
9	NC	--	No connection
10	/RST	L	Reset signal, active "L"
11	DB0	H/L	Data bus line
12	DB1	H/L	
13	DB2	H/L	
14	DB3	H/L	
15	DB4	H/L	
16	DB5	H/L	
17	DB6	H/L	
18	DB7	H/L	
19	FS	H/L	Font selection L: 8x8, H: 6x8
20	V <sub>OUT</sub>	-10V	Output voltage for LCD driving

## BLOCK DIAGRAM

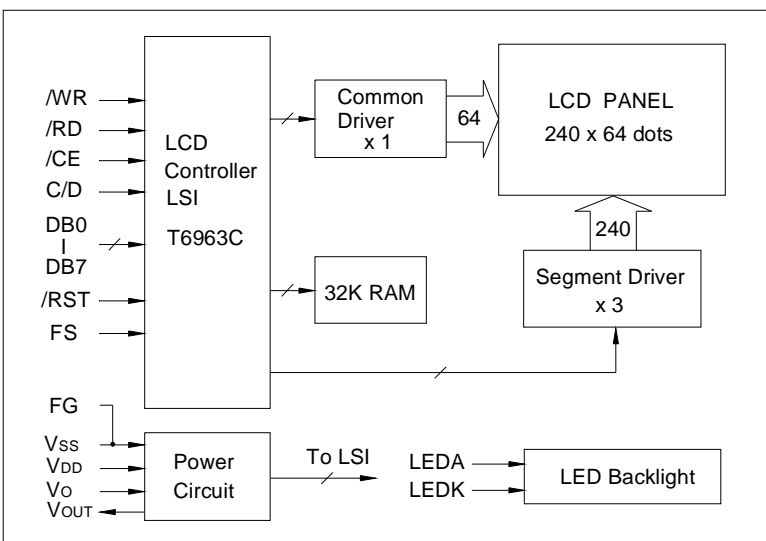

## LED BACKLIGHT SPECIFICATIONS (T<sub>a</sub>=25°C)

Item	Symbol	Typ.	Max.	Unit
Forward Voltage	V <sub>f</sub>	3.1	3.3	V
Forward Current	I <sub>f</sub>	120	--	mA
LED Color		White		