



GU2 SERIES SINGLE LED MODULE



FEATURES / BENEFITS

- ▲ Onboard drive accepts low voltage input
- ▲ Long life, up to 60,000 hours
- ▲ Low 1.5 watt power consumption
- ▲ Low profile - ADA compliant
- ▲ Optional niche mounting box available for direct burial in concrete or ground
- ▲ Uses the latest LUXEON® Rebel LED technology
- ▲ ETL listed to UL2108 standards for dry, damp or wet locations
- ▲ IP67 rated for interior or exterior use
- ▲ 40 lumen output for white. Consult factory for additional options

APPLICATIONS

Ideal for any difficult to maintain location low level pathway systems, architectural accent, staircases, decks, kitchens, etc. Easily mounts to wood, tile, stone, glass, stainless steel, etc

MATERIALS/FINISH

- ▲ Anodized aluminum base and “snap-on” top cover
- ▲ PMMA lens
- ▲ PTFE Lead Wires 20” (508mm) long, 20 AWG

OPERATING CONDITIONS

- ▲ Runs off 8-24 VDC or 10-14 VAC
- ▲ Current draw = 0.128A@ 12 VDC, 1.5 watts
- ▲ Multiple modules can be connected in parallel for longer runs off a single supply.
- ▲ Ambient Temperature limits -30°C to +55°C (-22°F to +131°F)

ORDERING INFORMATION

Guida 2 Base

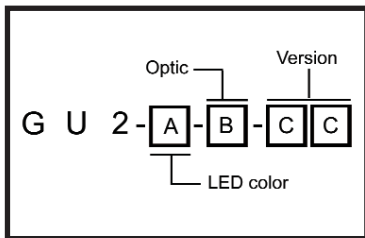

LED Color (A)	Optical Pattern (B)	Version (CC)
C = Cool White 5300K / *40 lumen min	D = Diffused	“Blank” = European Market Version
N = Neutral White 4000K / *40 lumen min	S = Spot	
W = Warm White 3050K / *40 lumen min		
R = Red		US = North America Version
G = Green		
B = Blue		
A = Amber		

Base & cover purchased separately

Guida 2 Covers

Series - Cover Type
GU - Dome
GU - Flush
GU - Eyelid

Mounting Box

GU-MBX = Euro version
GU-MBX-US = US version

* LED flux data is manufacturers test data @ 25°C T_j. Light output at max acceptable ambient temp will be approximately 25-30% lower, depending on thermal conductivity of mounting surface and lens type.

Dialight Lumidrives

York House • Weatherby Road • Long Marston, York, YO26 7NH
Tel: 0845 6346161 • Fax: 0845 6346160 • www.dialight.com

**PRIVATE LABEL
OEM PROGRAM**

Dialight Corporation

1501 Route 34 South • Farmingdale, NJ 07727 USA

Tel: (1) 732-919-3119 • Fax: (1) 732-751-5778 • www.dialight.com



MDEXLUMGU2_B

MOUNTING INFORMATION

Mounting box for physical setting & stability. It is not waterproof, make connections with waterproof wire nuts.

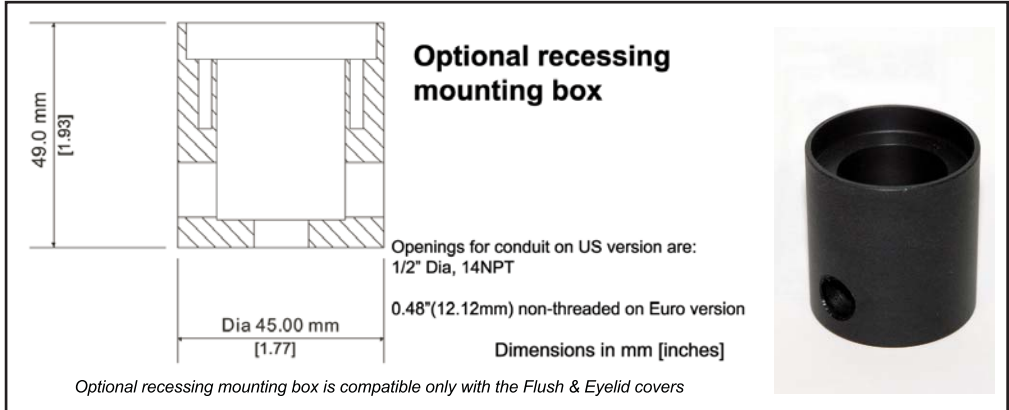
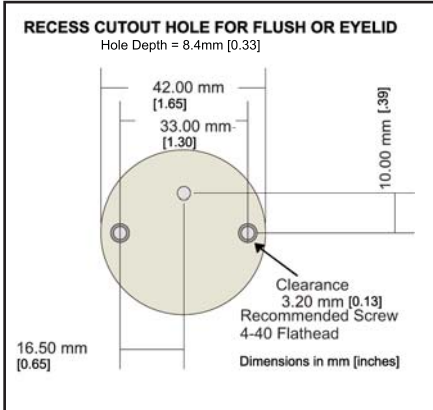

PHOTOMETRIC DATA

IES files available upon request

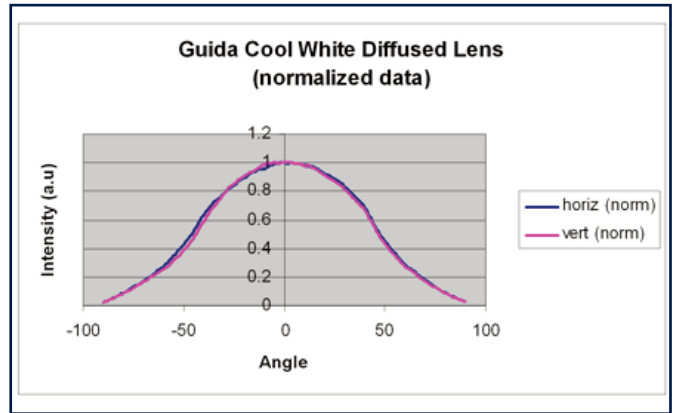
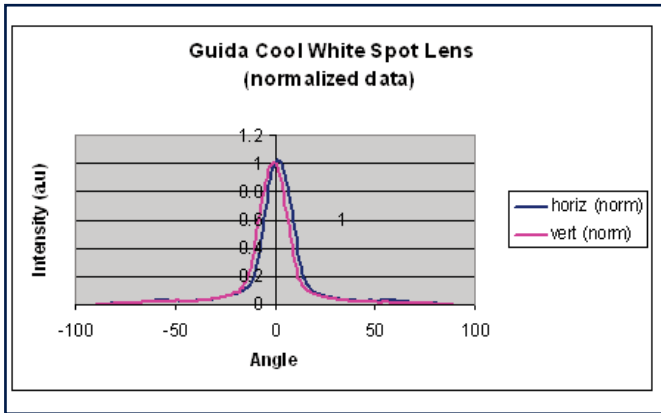

MECHANICAL DIMENSIONS

WIRING DIAGRAM

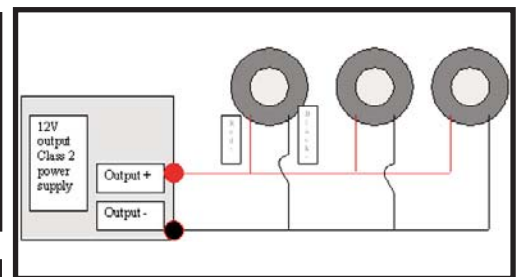
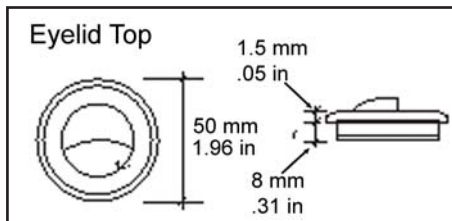
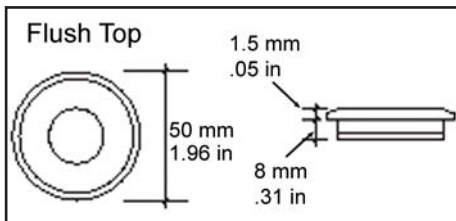
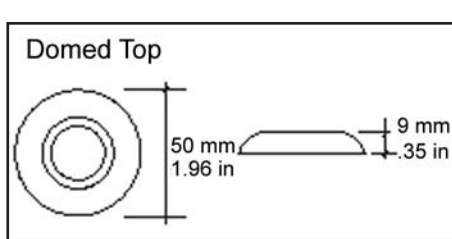
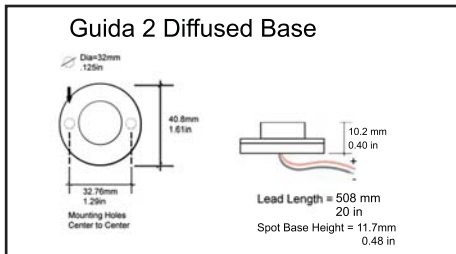

Dialight reserves the right to make changes at any time in order to supply the best product possible.

Eyelid top not compatible with spot base optic

PRIVATE LABEL OEM PROGRAM

Dialight Lumidrives

York House • Weatherby Road • Long Marston, York, YO26 7NH
Tel: 0845 6346161 • Fax: 0845 6346160 • www.dialight.com



Dialight Corporation

1501 Route 34 South • Farmingdale, NJ 07727 USA
Tel: (1) 732-919-3119 • Fax: (1) 732-751-5778 • www.dialight.com



MDEXLUMGU2_B