

Illuminated beacons and indicator banks

General :
pages 2 and 3
Characteristics :
pages 4 and 4
Dimensions :
pages 14 and 15

Illuminated beacons type XVB-L
for bulb with BA 15d base fitting

References

Illuminated beacons with steady light



XVB-L3●

Description	Light source	Colour	Reference	Weight kg
Complete unit comprising : 1 lens unit 1 base unit (direct or tube fixing)	Bulb (10 W max) not included 250 V max	Green	<u>XVB-L33</u>	0.260
		Red	<u>XVB-L34</u>	0.260
		Orange	<u>XVB-L35</u>	0.260
		Blue	<u>XVB-L36</u>	0.260
		Clear	<u>XVB-L37</u>	0.260
		Yellow	<u>XVB-L38</u>	0.260

Illuminated beacons with integral flashing light



XVB-L4B●

Complete unit comprising : 1 lens unit 1 base unit (direct or tube fixing)	Bulb (10 W max) not included ~ 24 V --- 24...48 V	Green	<u>XVB-L4B3</u>	0.280	
		Red	<u>XVB-L4B4</u>	0.280	
		Orange	<u>XVB-L4B5</u>	0.280	
		Blue	<u>XVB-L4B6</u>	0.280	
		Clear	<u>XVB-L4B7</u>	0.280	
		Yellow	<u>XVB-L4B8</u>	0.280	
		Bulb (10 W max) not included ~ 48...230 V	Green	<u>XVB-L4M3</u>	0.280
			Red	<u>XVB-L4M4</u>	0.280
Orange	<u>XVB-L4M5</u>		0.280		
Blue	<u>XVB-L4M6</u>		0.280		
Clear	<u>XVB-L4M7</u>		0.280		
Yellow	<u>XVB-L4M8</u>		0.280		

Illuminated beacons and indicator banks

Illuminated beacons type XVB-L with LED light source

General :
pages 2 and 3
Characteristics :
pages 4 and 5
Dimensions :
pages 14 and 15

References

Illuminated beacons with steady light



XVB-L0B

Description	Light source	Colour	Reference	Weight kg	
Complete unit comprising : 1 cover 1 lens unit 1 base unit (direct or tube fixing)	LED, included ≈ 24 V	Green	XVB-L0B3	0.270	
		Red	XVB-L0B4	0.270	
		Orange	XVB-L0B5	0.270	
		Blue	XVB-L0B6	0.270	
		Clear	XVB-L0B7	0.270	
		Yellow	XVB-L0B8	0.270	
		LED, included ~ 120	Green	XVB-L0G3	0.270
		Red	XVB-L0G4	0.270	
	Orange	XVB-L0G5	0.270		
Blue	XVB-L0G6	0.270			
Clear	XVB-L0G7	0.270			
Yellow	XVB-L0G8	0.270			
LED, included ~ 230 V	Green	XVB-L0M3	0.270		
	Red	XVB-L0M4	0.270		
	Orange	XVB-L0M5	0.270		
	Blue	XVB-L0M6	0.270		
	Clear	XVB-L0M7	0.270		
	Yellow	XVB-L0M8	0.270		

Illuminated beacons with integral flashing light



XVB-L1B

Complete unit comprising : 1 cover 1 lens unit 1 base unit (direct or tube fixing)	LED, included ≈ 24 V	Green	XVB-L1B3	0.280	
		Red	XVB-L1B4	0.280	
		Orange	XVB-L1B5	0.280	
		Blue	XVB-L1B6	0.280	
		Clear	XVB-L1B7	0.280	
		Yellow	XVB-L1B8	0.280	
		LED, included ~ 120 V	Green	XVB-L1G3	0.280
		Red	XVB-L1G4	0.280	
	Orange	XVB-L1G5	0.280		
Blue	XVB-L1G6	0.280			
Clear	XVB-L1G7	0.280			
Yellow	XVB-L1G8	0.280			
LED, included ~ 230 V	Green	XVB-L1M3	0.280		
	Red	XVB-L1M4	0.280		
	Orange	XVB-L1M5	0.280		
	Blue	XVB-L1M6	0.280		
	Clear	XVB-L1M7	0.280		
	Yellow	XVB-L1M8	0.280		

Illuminated beacons and indicator banks

Illuminated beacons type XVB-L with "flash" discharge tube

General :
pages 2 and 3
Characteristics :
pages 4 and 5
Dimensions :
pages 14 and 15

References

Illuminated beacons with 5 joule "flash" discharge tube



XVB-L6B●

Description	Light source	Colour	Reference	Weight kg	
Complete unit comprising : 1 lens unit 1 base unit (direct or tube fixing)	"Flash" discharge tube ≈ 24 V	Green	XVB-L6B3	0.440	
		Red	XVB-L6B4	0.440	
		Orange	XVB-L6B5	0.440	
		Blue	XVB-L6B6	0.440	
		Clear	XVB-L6B7	0.440	
		Yellow	XVB-L6B8	0.440	
		"Flash" discharge tube ~ 120 V	Green	XVB-L6G3	0.425
			Red	XVB-L6G4	0.425
Orange	XVB-L6G5		0.425		
Blue	XVB-L6G6		0.425		
Clear	XVB-L6G7		0.425		
Yellow	XVB-L6G8		0.425		
"Flash" discharge tube ~ 230 V	Green		XVB-L6M3	0.435	
	Red		XVB-L6M4	0.435	
	Orange	XVB-L6M5	0.435		
	Blue	XVB-L6M6	0.435		
	Clear	XVB-L6M7	0.435		
	Yellow	XVB-L6M8	0.435		

Illuminated beacons with 10 joule "flash" discharge tube



XVB-L8B●

Complete unit comprising : 1 lens unit 1 base unit (direct or tube fixing)	"Flash" discharge tube ≈ 24 V	Green	XVB-L8B3	0.450	
		Red	XVB-L8B4	0.450	
		Orange	XVB-L8B5	0.450	
		Blue	XVB-L8B6	0.450	
		Clear	XVB-L8B7	0.450	
		Yellow	XVB-L8B8	0.450	
		"Flash" discharge tube ~ 120 V	Green	XVB-L8G3	0.460
			Red	XVB-L8G4	0.460
Orange	XVB-L8G5		0.460		
Blue	XVB-L8G6		0.460		
Clear	XVB-L8G7		0.460		
Yellow	XVB-L8G8		0.460		
"Flash" discharge tube ~ 230 V	Green		XVB-L8M3	0.460	
	Red		XVB-L8M4	0.460	
	Orange	XVB-L8M5	0.460		
	Blue	XVB-L8M6	0.460		
	Clear	XVB-L8M7	0.460		
	Yellow	XVB-L8M8	0.460		

Illuminated beacons and indicator banks

General :
pages 2 and 3
Characteristics :
pages 4 and 5
Dimensions :
pages 14 and 15

Indicator banks type XVB-C for customer assembly (up to 5 units)
Illuminated lens units
for bulb with BA 15d base fitting

References

For use with base unit XVB-C●●, see page 12

Illuminated lens units with steady light



XVB-C3●

Description	Light source	Colour	Reference	Weight kg
Illuminated lens units	Bulb (10 W max) not included 250 V max	Green	<u>XVB-C33</u>	0.140
		Red	<u>XVB-C34</u>	0.140
		Orange	<u>XVB-C35</u>	0.140
		Blue	<u>XVB-C36</u>	0.140
		Clear	<u>XVB-C37</u>	0.140
		Yellow	<u>XVB-C38</u>	0.140

Illuminated lens units with integral flashing light



XVB-C4●●

Illuminated lens units	Bulb (10 W max) not included ~ 24 V --- 24...48 V	Green	<u>XVB-C4B3</u>	0.160		
		Red	<u>XVB-C4B4</u>	0.160		
		Orange	<u>XVB-C4B5</u>	0.160		
		Blue	<u>XVB-C4B6</u>	0.160		
		Clear	<u>XVB-C4B7</u>	0.160		
		Yellow	<u>XVB-C4B8</u>	0.160		
		Illuminated lens units	Bulb (10 W max) not included ~ 48...230 V	Green	<u>XVB-C4M3</u>	0.160
				Red	<u>XVB-C4M4</u>	0.160
Orange	<u>XVB-C4M5</u>			0.160		
Blue	<u>XVB-C4M6</u>			0.160		
Clear	<u>XVB-C4M7</u>			0.160		
Yellow	<u>XVB-C4M8</u>			0.160		

Illuminated beacons and indicator banks

Indicator banks type XVB-C for customer assembly (up to 5 units)
Illuminated lens units
with LED light source

General :
pages 2 and 3
Characteristics :
pages 4 and 5
Dimensions :
pages 14 and 15

References

For use with base unit XVB-C●●, see page 12

Illuminated lens units with steady light



XVB-C0●●

Description	Signalling	Colour	Reference	Weight kg	
Illuminated lens units	LED, included ≈ 24	Green	XVB-C0B3	0.150	
		Red	XVB-C0B4	0.150	
		Orange	XVB-C0B5	0.150	
		Blue	XVB-C0B6	0.150	
		Clear	XVB-C0B7	0.150	
		Yellow	XVB-C0B8	0.150	
		LED, included ~ 120 V	Green	XVB-C0G3	0.150
			Red	XVB-C0G4	0.150
Orange	XVB-C0G5		0.150		
Blue	XVB-C0G6		0.150		
Clear	XVB-C0G7		0.150		
Yellow	XVB-C0G8		0.150		
LED, included ~ 230 V	Green		XVB-C0M3	0.150	
	Red		XVB-C0M4	0.150	
	Orange	XVB-C0M5	0.150		
	Blue	XVB-C0M6	0.150		
	Clear	XVB-C0M7	0.150		
	Yellow	XVB-C0M8	0.150		

Illuminated lens units with integral flashing light



XVB-C1●●

Illuminated lens units	LED, included ≈ 24 V	Green	XVB-C1B3	0.170	
		Red	XVB-C1B4	0.170	
		Orange	XVB-C1B5	0.170	
		Blue	XVB-C1B6	0.170	
		Clear	XVB-C1B7	0.170	
		Yellow	XVB-C1B8	0.170	
		LED, included ~ 120 V	Green	XVB-C1G3	0.170
			Red	XVB-C1G4	0.170
Orange	XVB-C1G5		0.170		
Blue	XVB-C1G6		0.170		
Clear	XVB-C1G7		0.170		
Yellow	XVB-C1G8		0.170		
LED, included ~ 230 V	Green		XVB-C1M3	0.170	
	Red		XVB-C1M4	0.170	
	Orange	XVB-C1M5	0.170		
	Blue	XVB-C1M6	0.170		
	Clear	XVB-C1M7	0.170		
	Yellow	XVB-C1M8	0.170		

Illuminated beacons and indicator banks

Indicator banks type XVB-C for customer assembly (up to 5 units)
Illuminated lens units
with "flash" discharge tube

General :
pages 2 and 3
Characteristics :
pages 4 and 5
Dimensions :
pages 14 and 15

References

For use with base unit XVB-C●●, see page 12

Illuminated lens units with 5 joule "flash" discharge tube

Description	Light source	Colour	Reference	Weight kg	
Illuminated lens units	"Flash" discharge tube ≈ 24 V	Green	XVB-C6B3	0.295	
		Red	XVB-C6B4	0.295	
		Orange	XVB-C6B5	0.295	
		Blue	XVB-C6B6	0.295	
		Clear	XVB-C6B7	0.295	
		Yellow	XVB-C6B8	0.295	
		"Flash" discharge tube ~ 120 V	Green	XVB-C6G3	0.280
			Red	XVB-C6G4	0.280
	Orange		XVB-C6G5	0.280	
	Blue		XVB-C6G6	0.280	
	Clear		XVB-C6G7	0.280	
	Yellow		XVB-C6G8	0.280	
	"Flash" discharge tube ~ 230 V		Green	XVB-C6M3	0.290
			Red	XVB-C6M4	0.290
		Orange	XVB-C6M5	0.290	
		Blue	XVB-C6M6	0.290	
		Clear	XVB-C6M7	0.290	
		Yellow	XVB-C6M8	0.290	



XVB-C6●●

Illuminated lens units with 10 joule "flash" discharge tube

Illuminated lens units	"Flash" discharge tube ≈ 24 V	Green	XVB-C8B3	0.305	
		Red	XVB-C8B4	0.305	
		Orange	XVB-C8B5	0.305	
		Blue	XVB-C8B6	0.305	
		Clear	XVB-C8B7	0.305	
		Yellow	XVB-C8B8	0.305	
		"Flash" discharge tube ~ 120 V	Green	XVB-C8G3	0.315
			Red	XVB-C8G4	0.315
	Orange		XVB-C8G5	0.315	
	Blue		XVB-C8G6	0.315	
	Clear		XVB-C8G7	0.315	
	Yellow		XVB-C8G8	0.315	
	"Flash" discharge tube ~ 230 V		Green	XVB-C8M3	0.315
			Red	XVB-C8M4	0.315
		Orange	XVB-C8M5	0.315	
		Blue	XVB-C8M6	0.315	
		Clear	XVB-C8M7	0.315	
		Yellow	XVB-C8M8	0.315	

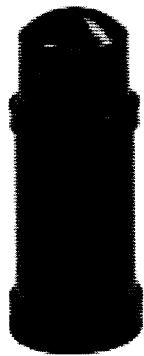

XVB-C8●●

Illuminated beacons and indicator banks

Indicator banks type XVB-C for customer assembly (up to 5 units)
Audible signalling units, base units, cover

General :
pages 2 and 3
Characteristics :
pages 4 and 5
Dimensions :
pages 14 and 15

References

Audible signalling units

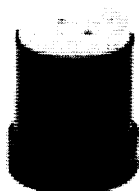

XVB-C9B

Description		Reference	Weight kg
Buzzer unit 90 dB at 1 m (75, ..., 90 dB) modes: continuous/intermittent	≈ 12...48 V	XVB-C9B	0.170
	~ 120...230 V	XVB-C9M	0.180
Loudspeaker unit	(1)	XVB-C9L0 ▲	-

Base units + cover (with set of 6 coloured markers)



XVB-C07

Base units for direct or tube fixing				
Description	For use with	Type	Reference	Weight kg
Base unit + cover with bottom or side cable entry	Banks without "flash" discharge tube	Standard	XVB-C21	0.190
Base unit only with bottom or side cable entry	Banks without "flash" discharge tube"	Standard	XVB-C07	0.160
Base unit + cover with bottom or side cable entry	All types of banks (1)	AS-i	XVB-C21A ▲	-
		Interbus	XVB-C21P ▲	-

(1) Value not communicated.

▲ Available
Mid 2000.

Illuminated beacons and indicator banks

General :
pages 2 and 3
Characteristics :
pages 4 and 5
Dimensions :
pages 14 and 15

Type XVB Accessories

References

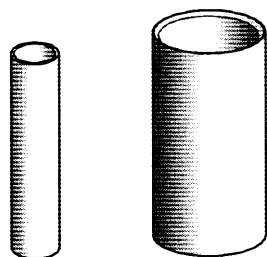

XVB-C02

XVB-C020

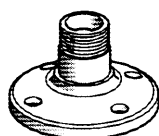

XVB-C11

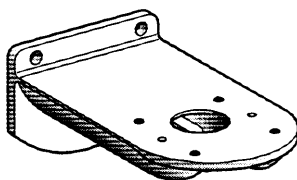

XVB-C12

Accessories common to beacons and indicator banks

Description	Characteristics	Unit reference	Weight kg	
Support tube supplied with clamping device on base unit	100 mm	XVB-C02	0.100	
	400 mm	XVB-C03	0.350	
	800 mm	XVB-C04	0.690	
Support tube concealment cover	100 mm	XVB-C020	0.080	
	400 mm	XVB-C030	0.305	
	800 mm	XVB-C040	0.610	
Fixing plate for horizontal surface	For mounting on tube XVB-C0●	XVB-C11	0.170	
Fixing plate for vertical surface	For direct mounting on base unit or with plate XVB-C11 + tube XVB-C0●	XVB-C12	0.380	
Incandescent bulbs BA 15d base fitting, 10 W (sold in lots of 10)	12 V	DL1-BLJ	0.090	
	24 V	DL1-BLB	0.090	
	48 V	DL1-BLE	0.090	
	120 V	DL1-BLG	0.090	
	230 V	DL1-BLM	0.090	
Incandescent bulbs BA 15d base fitting, 7 W (sold in lots of 10)	12 V	DL1-BEJ	0.090	
	24 V	DL1-BEB	0.090	
	48 V	DL1-BEE	0.090	
	120 V	DL1-BEG	0.090	
	230 V	DL1-BEM	0.090	
LEDs BA 15d base fitting (sold singly)	24 V	White	DL1-BDB1	0.015
		Green	DL1-BDB3	0.015
		Red	DL1-BDB4	0.015
		Blue	DL1-BDB6	0.015
		Yellow-orange	DL1-BDB8	0.015
	120 V	White	DL1-BDG1	0.015
		Green	DL1-BDG3	0.015
		Red	DL1-BDG4	0.015
		Blue	DL1-BDG6	0.015
		Yellow-orange	DL1-BDG8	0.015
	230 V	White	DL1-BDM1	0.015
		Green	DL1-BDM3	0.015
		Red	DL1-BDM4	0.015
		Blue	DL1-BDM6	0.015
		Yellow-orange	DL1-BDM8	0.015
Adaptors for side entry through base unit	With 13P cable gland	XVB-C14	0.015	
Adaptors for side entry through base unit for connecting to AS-i bus and Interbus	With 16P cable gland	XVB-C16 ▲	0.018	

Accessories specific to indicator banks

Set of coloured markers	6 colours	XVB-C22	0.001
Set of 5 legend holders	Identification of stacked units on base	XVB-C23	0.002
Sheet of 85 legends for legend holder (XVB-C23)	Identification of stacked units on base	XVB-CY1	0.005
Sheet of 52 legends	Identification of stacked units on locking ring	XVB-CY2	0.005
SIS labelling software creation of legends	Available on CD ROM Telephone : 01623 450546	SEUK 0131	0.060

▲ Available
Mid 2000.

Illuminated beacons and indicator banks

Type XVB

Characteristics

General :
pages 2 and 3
References :
pages 6 to 13
Dimensions :
pages 14 and 15

Environment

Approvals	Standard version, CSA, UL		Pending
Conforming to standards	Standard version		IEC/EN 60947-5-1
Protective treatment			"TC"
Ambient air temperature			
Storage		°C	- 40...+ 70
Operation (1)	Illuminated lens unit, steady	°C °C	- 25...+ 70, with incandescent bulb 10 W. - 25...+ 50, with LED
	Flashing units	°C °C °C	- 25...+ 50, with incandescent bulb 7 W - 25...+ 40, with incandescent bulb 10 W - 25...+ 50, with LED
	Units with "flash" discharge tube"	°C	- 25...+ 50
	Audible signalling units	°C	- 25...+ 50, with buzzer
Electric shock protection conforming to IEC 536	Tube mounting		Class I
	Direct mounting on base unit		Class II
Degree of protection	To IEC 529 and NF C 20-010 To UL 508		IP 65 Type 4X NEMA "indoor"
Material	Illuminated lens unit		Polycarbonate
	Base unit and top cover		Glass-reinforced polyamide and polycarbonate
	Tube		Stainless steel
	Fixing plate		Zamak

(1) Warning : combining of illuminated units with incandescent lamps and LED illuminated units is forbidden. Moreover, when associating different elements such as steady or flashing, the maximum temperature is limited to that of weaker element.

Illuminated beacons and indicator banks

Type XVB

General :
pages 2 and 3
References :
pages 6 to 13
Dimensions :
pages 14 and 15

Characteristics (continued)

Electrical characteristics

Rated insulation voltage (Ui)	Conforming to IEC 947-1	V	250
Consumption	LED unit		
	Steady	mA	≈ 24 V : < 80 ≈ 120...230 V : < 30
	Flashing	mA	≈ 24 V : < 40 ≈ 120...230 V : < 15
	Unit with discharge tube (on energisation)	mA	≈ 24 V : 5J unit : < 430 ; 10J unit : < 850 ≈ 120 V : 5J unit : < 130 ; 10J unit : < 260 ≈ 230 V : 5J unit : < 105 ; 10J unit : < 210
	Audible signalling units	mA	≈ 12...48 V : < 20 ≈ 120...230 V : < 50
Rated impulse withstand voltage	Conforming to IEC 947-1	kV	U imp = 4
Bulb type	Illuminated units, steady or flashing		Bulbs with BA 15d base fitting, minimum power 5 W, maximum power 10 W
Illuminating power	Units with discharge circuit ("flash" lamp with integral tube)	cds	13 (integral high intensity tube) with clear lens unit: 5J tube 26 (integral high intensity tube) with clear lens unit: 10J tube
Audible signalling unit	Continuous or intermittent signal	dB	90 at 1 m
	Fundamental frequency	kHz	2.8
Terminal referencing	Common to all 5 units		1 terminal referenced "C"
	Depending on number of units		1 or 5 terminals referenced 1 to 5
Cabling	Maximum clamping capacity on protected, ready-to-tighten, screw and captive cable clamp terminals	mm ²	1 x 1.5 with cable end
Frequency of illuminated units	Flashing units	Hz	1
	Units with discharge tube	Hz	1

Illuminated beacons and indicator banks

Type XVB

Dimensions

General :
pages 2 and 3
Characteristics :
pages 4 and 5
References :
pages 6 to 13

Illuminated beacons XVB-L●●●
For bulb with BA 15d base fitting or LED

With "flash" discharge tube

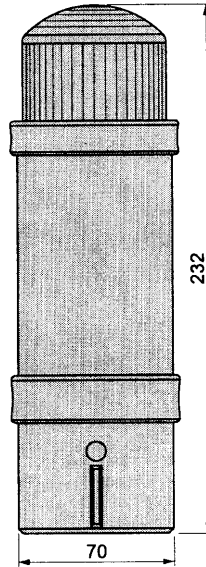
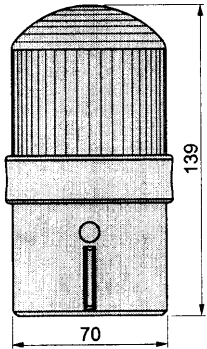

Indicator banks XVB-C
Without "flash" discharge tube

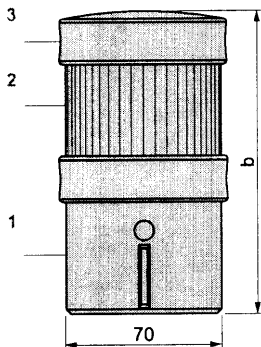

- 1 + 3 = Base unit + cover XVB-C21
- 2 Illuminated or audible signalling unit XVB-C●●●

With "flash" discharge tube

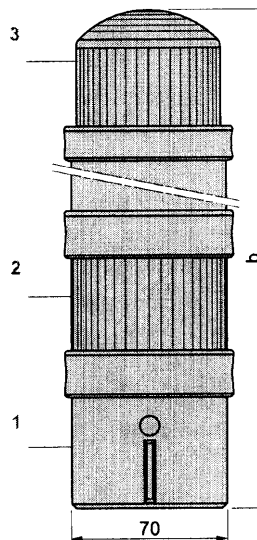

- 1 Base unit XVB-C07
- 2 Illuminated or audible signalling unit XVB-C●●●
- 3 "Flash" unit XVB-C●●●

Number of illuminated or audible signalling units (no "flash")	b
1	138
2	201
3	264
4	327
5	390

Number of illuminated or audible signalling units other than "flash" tube	b
1	295
2	358
3	421
4	484

Panel cut-out for direct fixing (on base unit XVB-C21, XVB-C07, XVB-C21A or XVB-C21P)

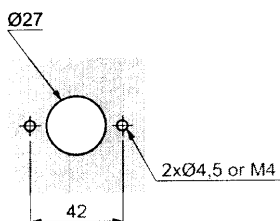

Illuminated beacons and indicator banks

Type XVB

General :
pages 2 and 3
Characteristics :
pages 4 and 5
References :
pages 6 to 13

Dimensions (continued)

Support tube XVB-C0● and fixing plate for horizontal surface XVB-C11

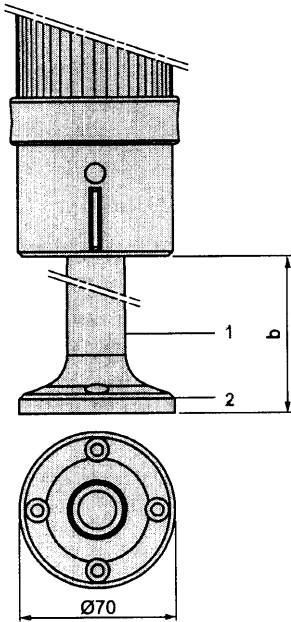

- 1 Support tube XVB-C0● Ø 25 mm
- 2 Fixing plate for vertical surface XVB-C12

	b
XVB-C02	77
XVB-C03	377
XVB-C04	777

Cut-out in horizontal panel for fixing on plate XVB-C11

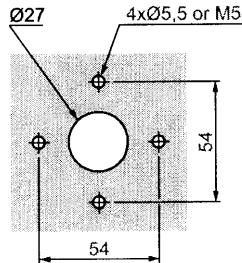

Fixing plate for vertical surface XVB-C12 Direct mounting on base unit

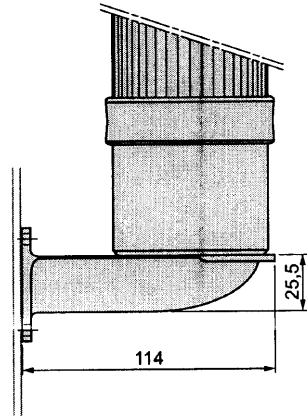
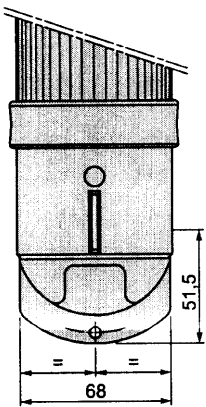

Mounting by means of plate XVB-C11 screwed onto tube XVB-C0●

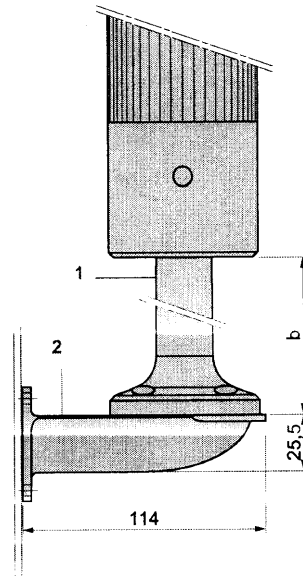

Cut-out in vertical panel for fixing on plate XVB-C12

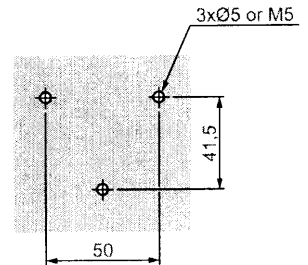

- 1 Tube Ø 25 mm
- 2 Fixing plate for vertical surface XVB-C12

	b
XVB-C02	77
XVB-C03	377
XVB-C04	777

Wiring scheme

