

# 1SS367

## SILICON EPITAXIAL SCHOTTKY BARRIER DIODE

### Features

- Low forward voltage

### Applications

- High Speed Switching

### PINNING

PIN	DESCRIPTION
1	Cathode
2	Anode

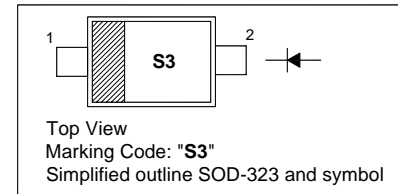

### Absolute Maximum Ratings ( $T_a = 25\text{ }^\circ\text{C}$ )

Parameter	Symbol	Value	Unit
Maximum (Peak) Reverse Voltage	$V_{RM}$	15	V
Reverse Voltage	$V_R$	10	V
Average Forward Current	$I_O$	100	mA
Maximum (Peak) Forward Current	$I_{FM}$	200	mA
Surge Current (10 ms)	$I_{FSM}$	1	A
Power Dissipation	$P_{tot}$	200	mW
Junction Temperature	$T_J$	125	$^\circ\text{C}$
Operating Temperature Range	$T_{opr}$	- 40 to + 100	$^\circ\text{C}$
Storage Temperature Range	$T_s$	- 55 to + 125	$^\circ\text{C}$

### Characteristics at $T_a = 25\text{ }^\circ\text{C}$

Parameter	Symbol	Max.	Unit
Forward Voltage at $I_F = 5\text{ mA}$ at $I_F = 100\text{ mA}$	$V_F$	0.3 0.5	V
Reverse Current at $V_R = 10\text{ V}$	$I_R$	20	$\mu\text{A}$
Total Capacitance at $f = 1\text{ MHz}$	$C_T$	40	pF

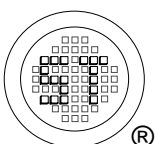

**SEMTECH ELECTRONICS LTD.**

(Subsidiary of Sino-Tech International Holdings Limited, a company  
listed on the Hong Kong Stock Exchange, Stock Code: 724)



Dated : 01/09/2006

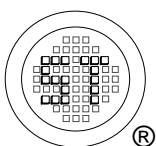
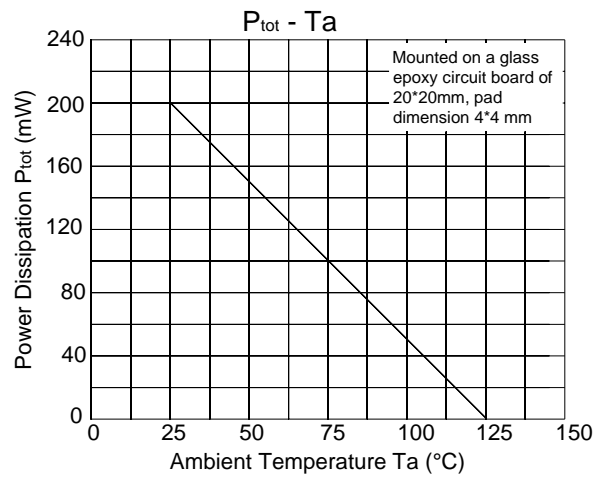
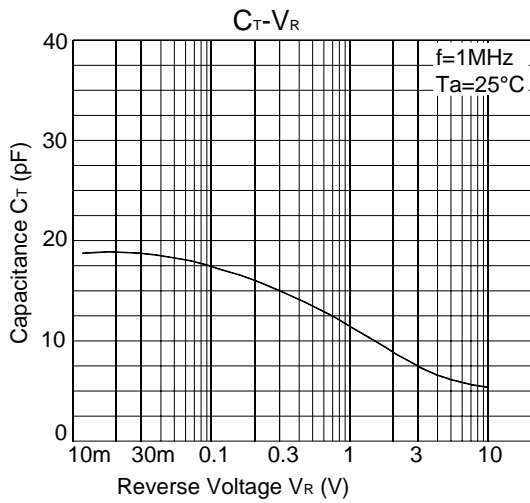
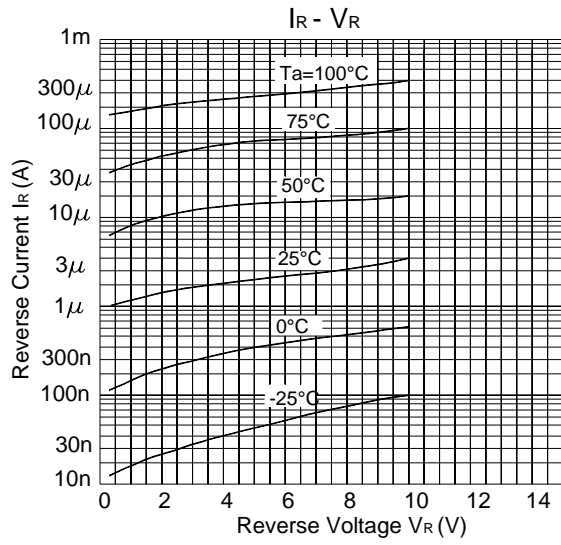
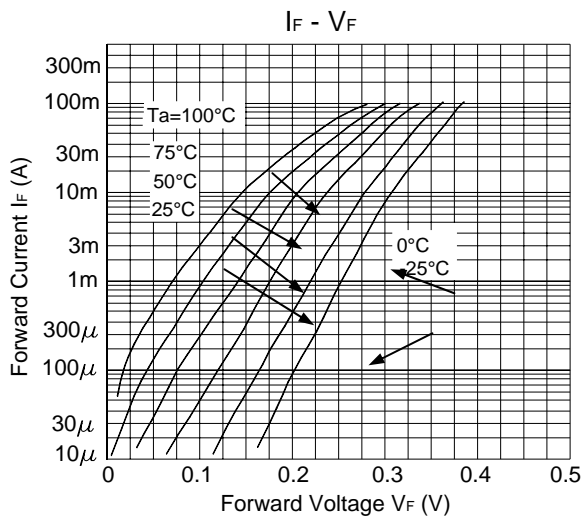

**SEMTECH ELECTRONICS LTD.**  
 (Subsidiary of Sino-Tech International Holdings Limited, a company  
 listed on the Hong Kong Stock Exchange, Stock Code: 724)



ISO/TS 16949 : 2002 Certificate No. 05103  
 ISO 14001:2004 Certificate No. 7116  
 ISO 9001:2000 Certificate No. 0506098

PACKAGE OUTLINE

Plastic surface mounted package; 2 leads

SOD-323

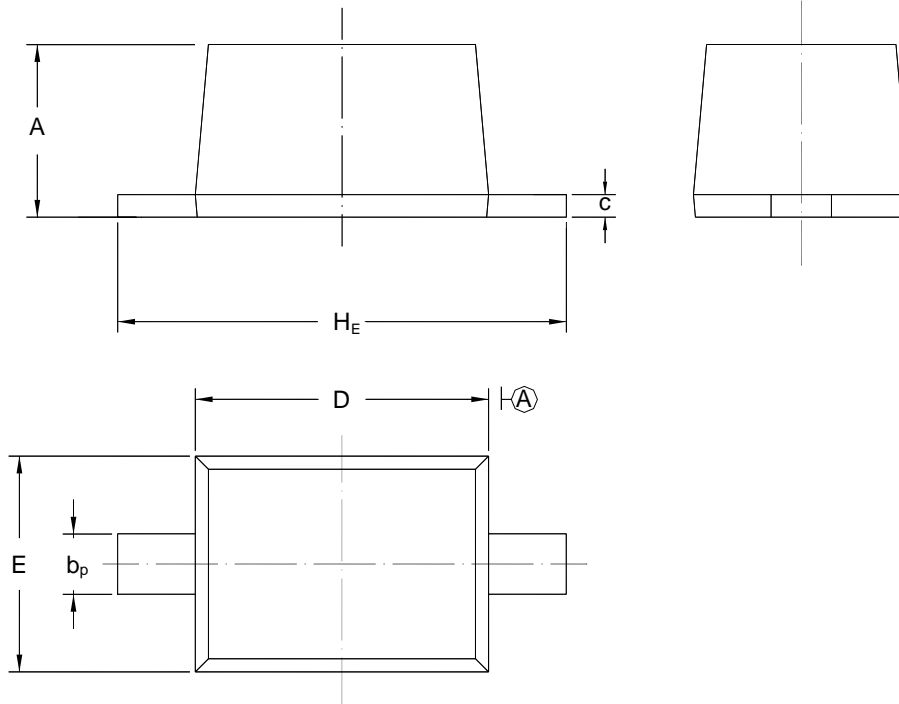

UNIT	A	b <sub>p</sub>	C	D	E	H <sub>E</sub>
mm	1.10 0.80	0.40 0.25	0.15 0.00	1.80 1.60	1.35 1.15	2.80 2.30

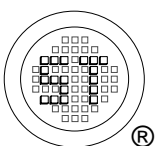

**SEMTECH ELECTRONICS LTD.**  
 (Subsidiary of Sino-Tech International Holdings Limited, a company  
 listed on the Hong Kong Stock Exchange, Stock Code: 724)



ISO/TS 16949 : 2002 Certificate No. 05103  
 ISO 14001:2004 Certificate No. 7116  
 ISO 9001:2000 Certificate No. 0506098

Dated : 01/09/2006