

750MHz, Low Distortion Unity Gain, Closed Loop Buffer

The HFA1110 is a unity gain closed loop buffer that achieves -3dB bandwidth of 750MHz, while offering excellent video performance and low distortion. Manufactured on Intersil's proprietary complementary bipolar UHF-1 process, the HFA1110 also offers very fast slew rate, and high output current. It is one more example of Intersil's intent to enhance its leadership position in products for high speed signal processing applications.

The HFA1110's settling time of 11ns to 0.1%, low distortion and ability to drive capacitive loads make it an ideal flash A/D driver.

The HFA1110 is an enhanced, pin compatible upgrade for the AD9620, AD9630, CLC110, EL2072, BUF600 and BUF601.

For buffer applications requiring a standard op amp pinout, or selectable gain (-1, +1, +2), see the HFA1112 data sheet. For output limiting see the HFA1113 data sheet.

For military grade product please refer to the HFA1110/883 data sheet.

Pinout

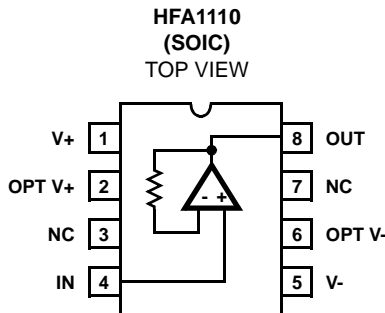

Pin Descriptions

NAME	PIN NUMBER	DESCRIPTION
V+	1	Positive Supply
Opt V+	2	Optional Positive Supply
NC	3	No Connection
IN	4	Input
V-	5	Negative Supply
Opt V-	6	Optional Negative Supply
NC	7	No Connection
OUT	8	Output

Features

- Wide -3dB Bandwidth. 750MHz
- Very Fast Slew Rate. 1300V/μs
- Fast Settling Time (0.2%). 7ns
- High Output Current. 60mA
- Fixed Gain of +1
- Gain Flatness (100MHz) 0.03dB
- Differential Phase. 0.025°
- Differential Gain 0.04%
- 3rd Harmonic Distortion (50MHz). -80dBc
- 3rd Order Intercept (100MHz) 30dBm
- Pb-Free Plus Anneal Available (RoHS Compliant)

Applications

- Video Switching and Routing
- RF/IF Processors
- Driving Flash A/D Converters
- High-Speed Communications
- Impedance Transformation
- Line Driving
- Radar Systems

Ordering Information

PART NUMBER	PART MARKING	TEMP. RANGE (°C)	PACKAGE	PKG. DWG. #
HFA1110IB	1110IB	-40 to 85	8 Ld SOIC	M8.15
HFA1110IBZ (Note)	1110IBZ	-40 to 85	8 Ld SOIC (Pb-free)	M8.15
HFA1110EVAL	High Speed Buffer DIP Evaluation Board			

NOTE: Intersil Pb-free plus anneal products employ special Pb-free material sets; molding compounds/die attach materials and 100% matte tin plate termination finish, which are RoHS compliant and compatible with both SnPb and Pb-free soldering operations. Intersil Pb-free products are MSL classified at Pb-free peak reflow temperatures that meet or exceed the Pb-free requirements of IPC/JEDEC J STD-020.

HFA1110

Absolute Maximum Ratings

Voltage Between V+ and V-	12V
DC Input Voltage	V _{SUPPLY}
Output Current	60mA

Operating Conditions

Temperature Range	-40°C to 85°C
-----------------------------	---------------

Thermal Information

Thermal Resistance (Typical, Note 1)	θ_{JA} (°C/W)
SOIC Package	158
Maximum Junction Temperature (Plastic Package)	150°C
Maximum Storage Temperature Range	-65°C to 150°C
Maximum Lead Temperature (Soldering 10s)	300°C (SOIC - Lead Tips Only)

CAUTION: Stresses above those listed in "Absolute Maximum Ratings" may cause permanent damage to the device. This is a stress only rating and operation of the device at these or any other conditions above those indicated in the operational sections of this specification is not implied.

NOTE:

- θ_{JA} is measured with the component mounted on an evaluation PC board in free air.

Electrical Specifications $V_{SUPPLY} = \pm 5V, R_L = 100\Omega$, Unless Otherwise Specified

PARAMETER	TEST CONDITIONS	TEMP (°C)	MIN	TYP	MAX	UNITS
INPUT CHARACTERISTICS						
Output Offset Voltage (Note 2)		25	-	8	25	mV
		Full	-	-	35	mV
Output Offset Voltage Drift		Full	-	10	-	$\mu V/^\circ C$
PSRR		25	39	45	-	dB
		Full	35	-	-	dB
Input Noise Voltage (Note 2)	100kHz	25	-	14	-	nV/\sqrt{Hz}
Input Noise Current (Note 2)	100kHz	25	-	51	-	pA/\sqrt{Hz}
Input Bias Current (Note 2)		25	-	10	40	μA
		Full	-	-	65	μA
Input Resistance		25	25	50	-	k Ω
Input Capacitance		25	-	2	-	pF
TRANSFER CHARACTERISTICS						
Gain	$V_{OUT} = 2V_{P-P}$	25	0.980	0.990	1.02	V/V
		Full	0.975	-	1.025	V/V
DC Non-Linearity (Note 2)	$\pm 2V$ Full Scale	25	-	0.003	-	%
OUTPUT CHARACTERISTICS						
Output Voltage (Note 2)		25	3.0	3.3	-	$\pm V$
		Full	2.5	3.0	-	$\pm V$
Output Current (Note 2)	$R_L = 50\Omega$	25, 85	50	60	-	mA
		-40	35	50	-	mA
POWER SUPPLY CHARACTERISTICS						
Supply Voltage Range		Full	4.5	-	5.5	$\pm V$
Supply Current (Note 2)		25	-	21	26	mA
		Full	-	-	33	mA
AC CHARACTERISTICS						
-3dB Bandwidth (Note 2)	$V_{OUT} = 0.2V_{P-P}$	25	-	750	-	MHz
Slew Rate	$V_{OUT} = 5V_{P-P}$	25	-	1300	-	V/ μs
Full Power Bandwidth (Note 2)	$V_{OUT} = 4V_{P-P}$	25	-	150	-	MHz
Gain Flatness (Note 2)	To 100MHz	25	-	± 0.03	-	dB
	To 30MHz	25	-	± 0.01	-	dB
Linear Phase Deviation (Note 2)	DC to 100MHz	25	-	± 0.3	-	°
2nd Harmonic Distortion (Note 2)	50MHz, $V_{OUT} = 2V_{P-P}$	25	-	-60	-	dBc
3rd Harmonic Distortion (Note 2)	50MHz, $V_{OUT} = 2V_{P-P}$	25	-	-80	-	dBc
3rd Order Intercept (Note 2)	100MHz	25	-	30	-	dBm

HFA1110

Electrical Specifications $V_{SUPPLY} = \pm 5V$, $R_L = 100\Omega$, Unless Otherwise Specified (Continued)

PARAMETER	TEST CONDITIONS	TEMP (°C)	MIN	TYP	MAX	UNITS
-1dB Gain Compression	100MHz	25	-	14	-	dBm
Reverse Gain (S_{12} , Note 2)	100MHz, $V_{OUT} = 1V_{P-P}$	25	-	-60	-	dB
TRANSIENT RESPONSE						
Rise Time	$V_{OUT} = 0.5V$ Step	25	-	0.5	-	ns
Overshoot (Note 2)	$V_{OUT} = 1.0V$ Step, Input Signal Rise/Fall = 1ns	25	-	2.5	-	%
0.2% Settling Time (Note 2)	$V_{OUT} = 1V$ to $0V$	25	-	7	-	ns
0.1% Settling Time (Note 2)	$V_{OUT} = 1V$ to $0V$	25	-	11	-	ns
Overdrive Recovery Time		25	-	15	-	ns
Differential Gain	3.58MHz, $R_L = 75\Omega$	25	-	0.04	-	%
Differential Phase	3.58MHz, $R_L = 75\Omega$	25	-	0.025	-	°

NOTE:

- See Typical Performance Curves for more information.

Application Information

PC Board Layout

The frequency performance of this amplifier depends a great deal on the amount of care taken in designing the PC board.

The use of low inductance components such as chip resistors and chip capacitors is strongly recommended, while a solid ground plane is a must!

Attention should be given to decoupling the power supplies. A large value ($10\mu F$) tantalum in parallel with a small value chip ($0.1\mu F$) capacitor works well in most cases.

Terminated microstrip signal lines are recommended at the input and output of the device. Output capacitance, such as that resulting from an improperly terminated transmission line will degrade the frequency response of the amplifier and may cause oscillations. In most cases, the oscillation can be avoided by placing a resistor (R_S) in series with the output. See the "Recommended R_S vs Load Capacitance" graph for specific recommendations.

An example of a good high frequency layout is the Evaluation Board shown below.

Evaluation Board

An evaluation board is available for the HFA1110 (part number HFA1110EVAL). Please contact your local sales office for information.

The layout and schematic of the board are shown here:

NOTE: The SOIC version may be evaluated in the DIP board by using a SOIC-to-DIP adapter such as Aries Electronics Part Number 08-350000-10.

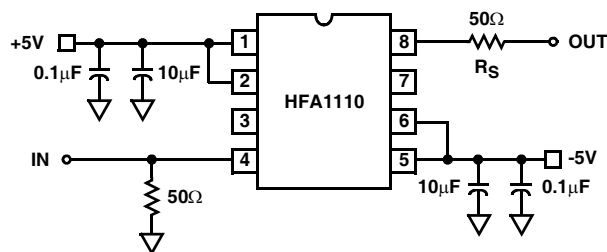

SCHEMATIC DIAGRAM

BOTTOM LAYOUT

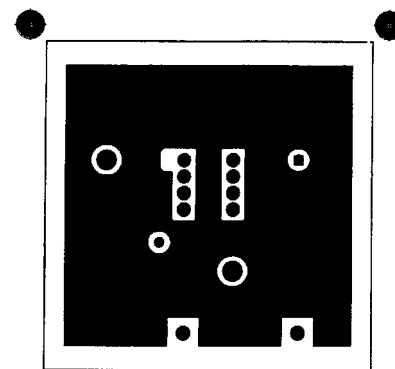

TOP LAYOUT

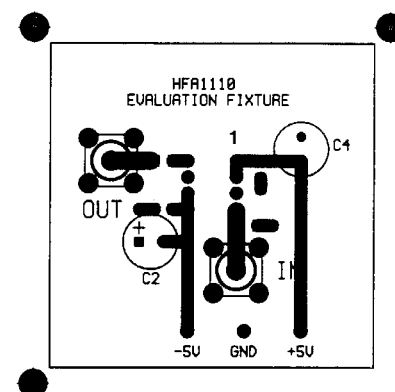

Typical Performance Curves $V_{SUPPLY} = \pm 5V$, $T_A = 25^\circ C$, $R_L = 100\Omega$, Unless Otherwise Specified

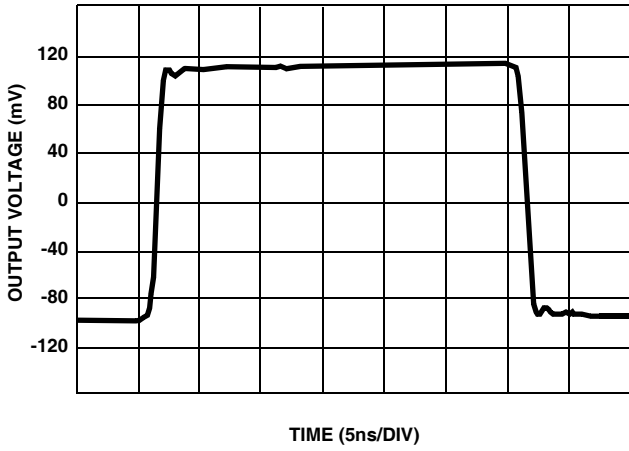

FIGURE 1. SMALL SIGNAL PULSE RESPONSE

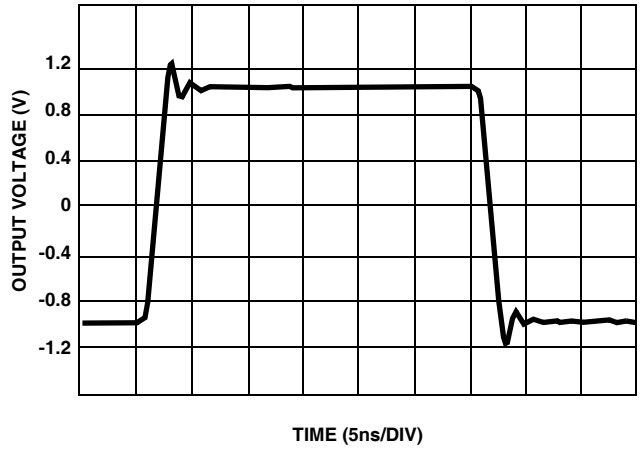

FIGURE 2. LARGE SIGNAL PULSE RESPONSE

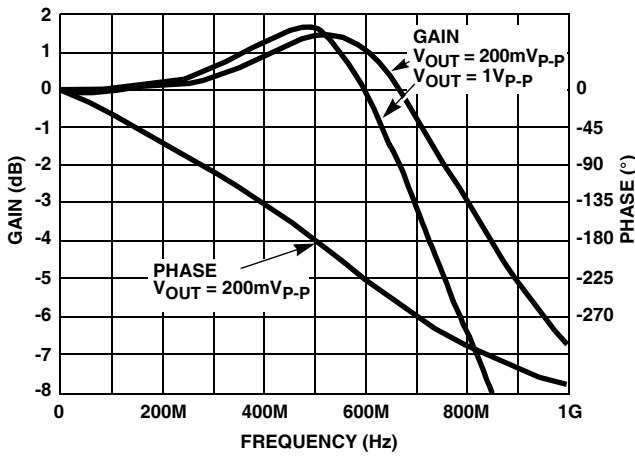

FIGURE 3. FREQUENCY RESPONSE

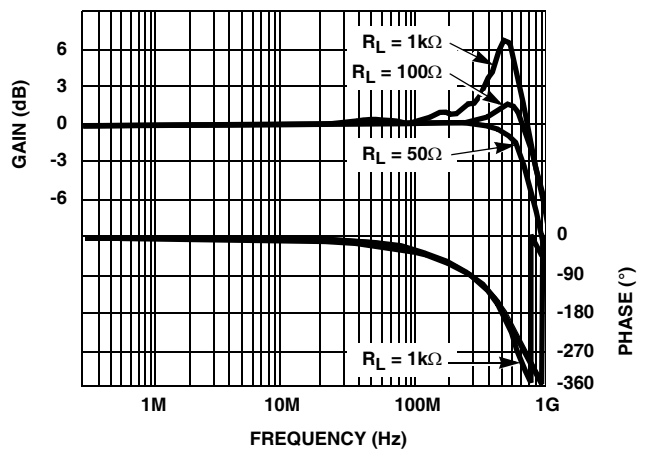

FIGURE 4. FREQUENCY RESPONSE FOR VARIOUS LOAD RESISTORS

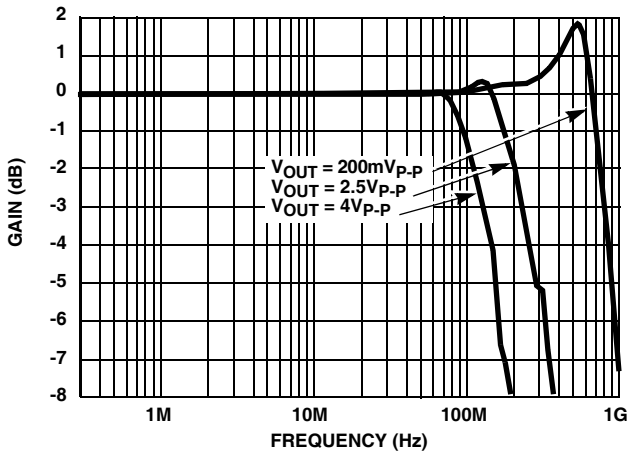

FIGURE 5. FREQUENCY RESPONSE FOR VARIOUS OUTPUT VOLTAGES

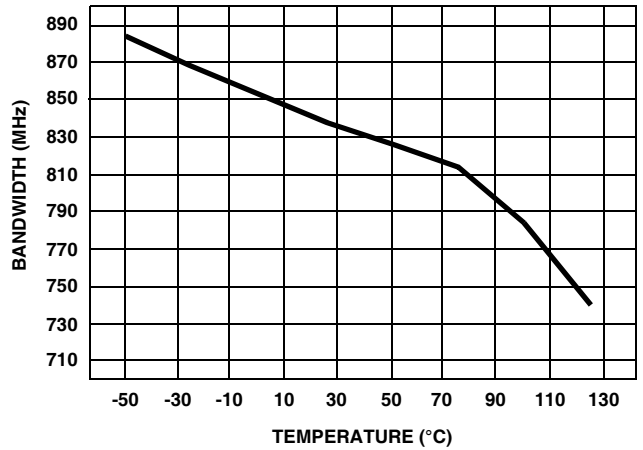

FIGURE 6. -3dB BANDWIDTH vs TEMPERATURE

Typical Performance Curves $V_{SUPPLY} = \pm 5V$, $T_A = 25^\circ C$, $R_L = 100\Omega$, Unless Otherwise Specified (Continued)

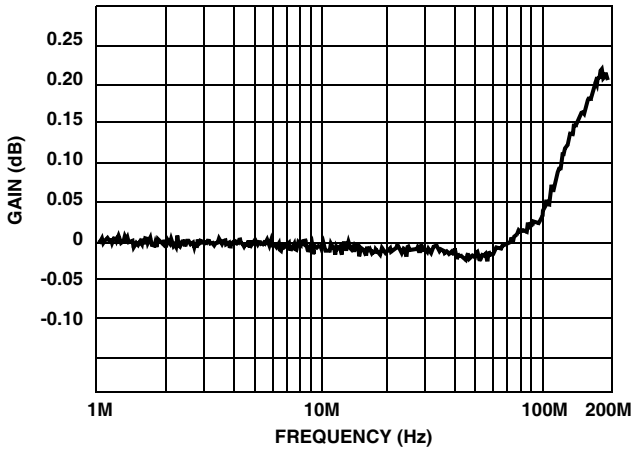

FIGURE 7. GAIN FLATNESS

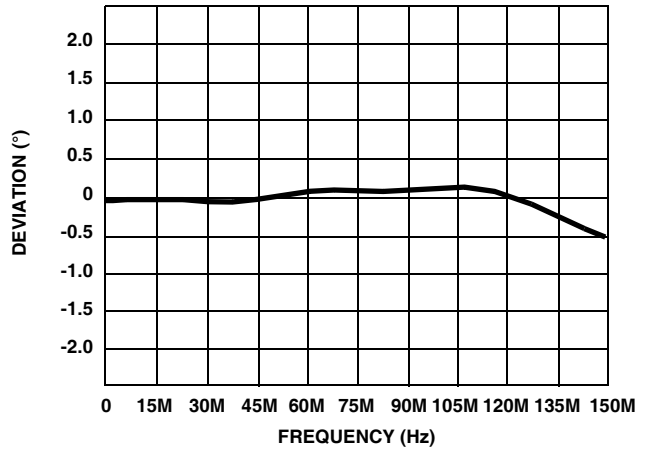

FIGURE 8. DEVIATION FROM LINEAR PHASE

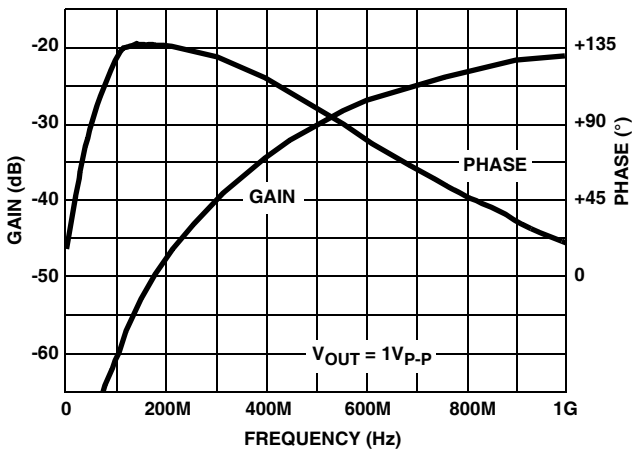

FIGURE 9. REVERSE GAIN AND PHASE (S_{12})

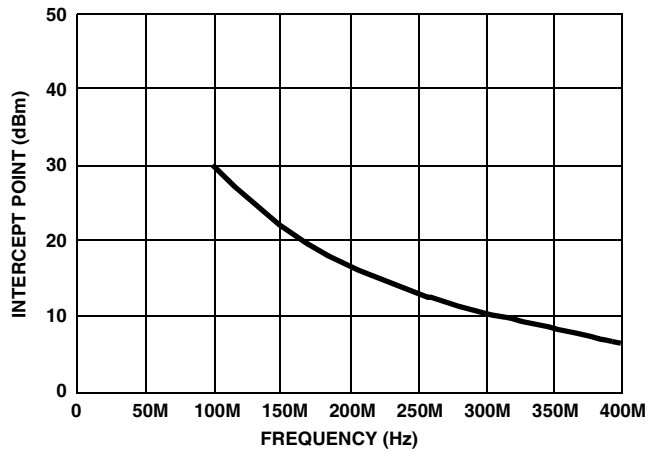

FIGURE 10. TWO-TONE, THIRD ORDER INTERMODULATION INTERCEPT

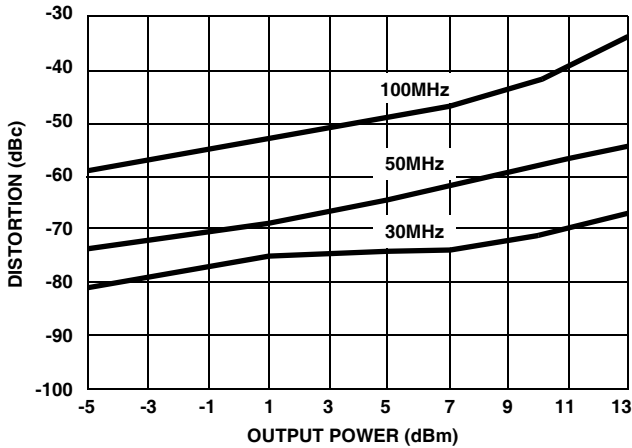

FIGURE 11. SECOND HARMONIC DISTORTION vs P_{OUT}

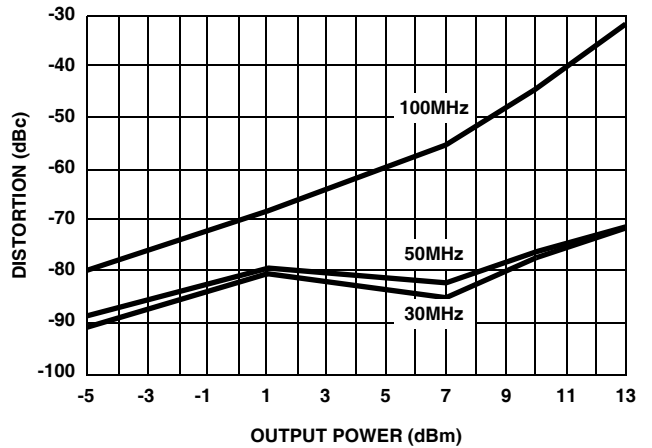

FIGURE 12. THIRD HARMONIC DISTORTION vs P_{OUT}

Typical Performance Curves $V_{SUPPLY} = \pm 5V$, $T_A = 25^\circ C$, $R_L = 100\Omega$, Unless Otherwise Specified (Continued)

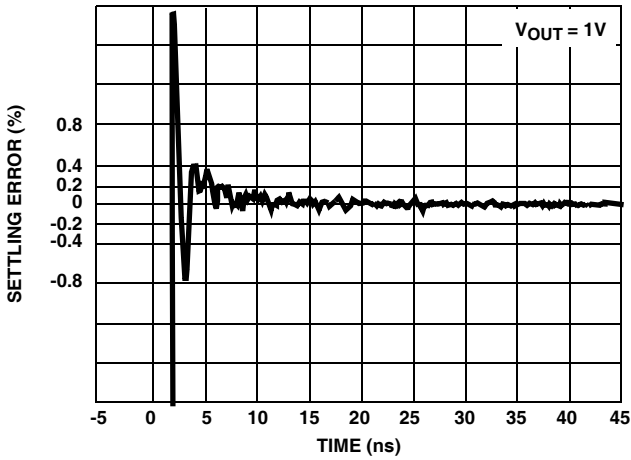

FIGURE 13. SETTLING RESPONSE

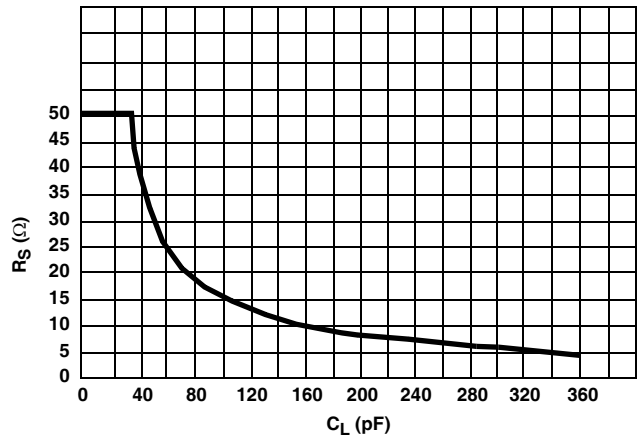

FIGURE 14. RECOMMENDED SERIES OUTPUT RESISTOR vs C_{LOAD}

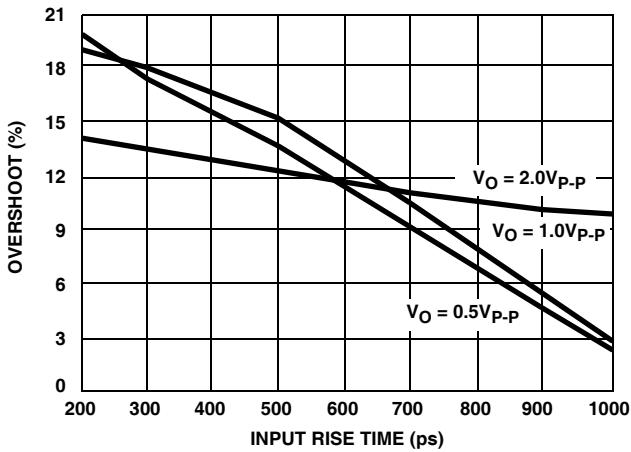

FIGURE 15. OVERSHOOT vs INPUT RISE TIME

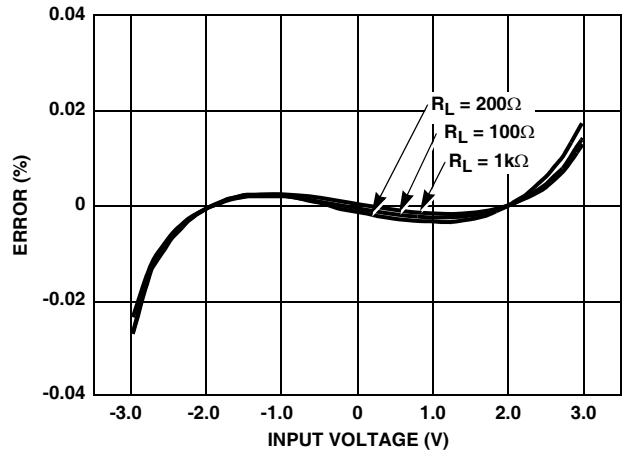

FIGURE 16. INTEGRAL LINEARITY ERROR

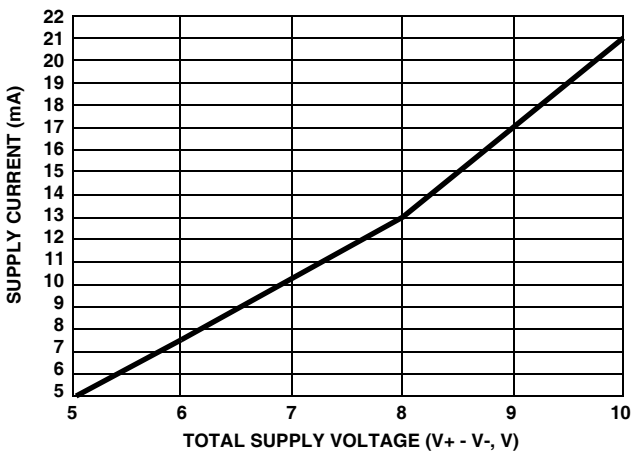

FIGURE 17. SUPPLY CURRENT vs SUPPLY VOLTAGE

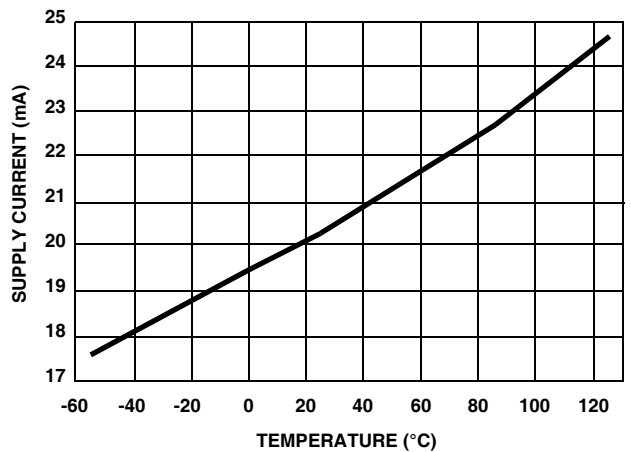

FIGURE 18. SUPPLY CURRENT vs TEMPERATURE

HFA1110

Typical Performance Curves $V_{SUPPLY} = \pm 5V$, $T_A = 25^\circ C$, $R_L = 100\Omega$, Unless Otherwise Specified (Continued)

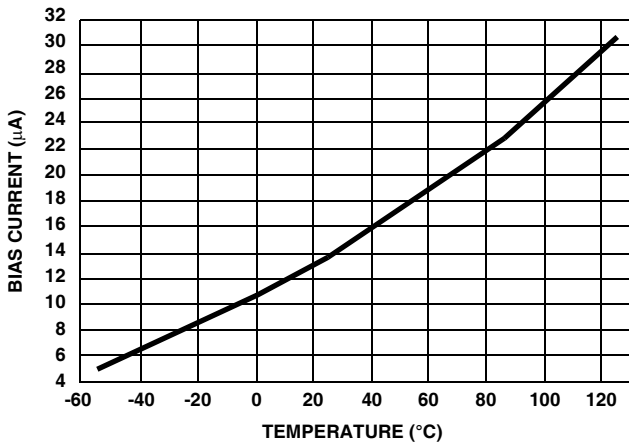

FIGURE 19. BIAS CURRENT vs TEMPERATURE

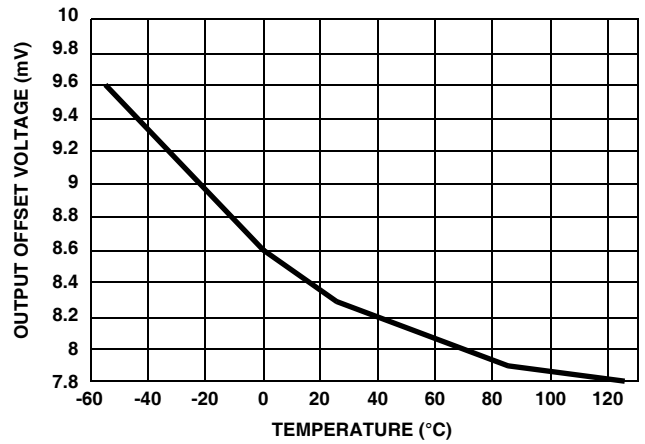

FIGURE 20. OFFSET VOLTAGE vs TEMPERATURE

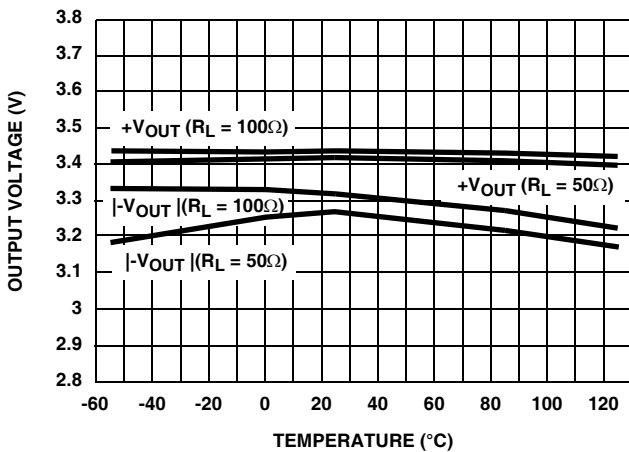

FIGURE 21. OUTPUT VOLTAGE vs TEMPERATURE

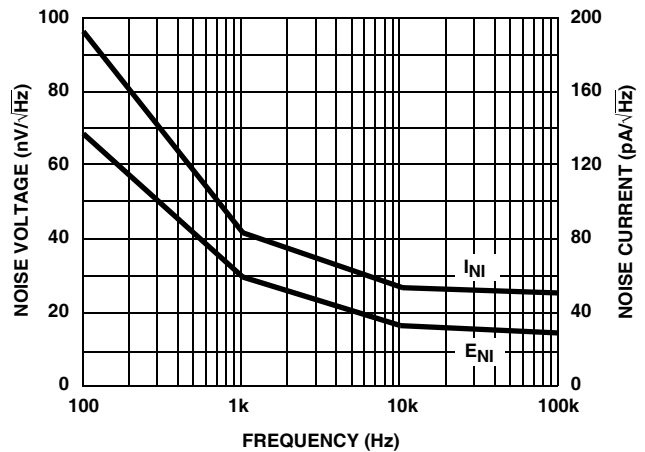

FIGURE 22. INPUT NOISE vs FREQUENCY

HFA1110

Die Characteristics

DIE DIMENSIONS:

63 mils x 44 mils x 19 mils
1600 μ m x 1130 μ m x 483 μ m

METALLIZATION:

Type: Metal 1: AlCu(2%)/TiW
Thickness: Metal 1: 8k \AA \pm 0.4k \AA
Type: Metal 2: AlCu(2%)
Thickness: Metal 2: 16k \AA \pm 0.8k \AA

PASSIVATION:

Type: Nitride
Thickness: 4k \AA \pm 0.5k \AA

TRANSISTOR COUNT:

52

SUBSTRATE POTENTIAL (POWERED UP):

Floating (Recommend Connection to V-)

Metallization Mask Layout

HFA1110

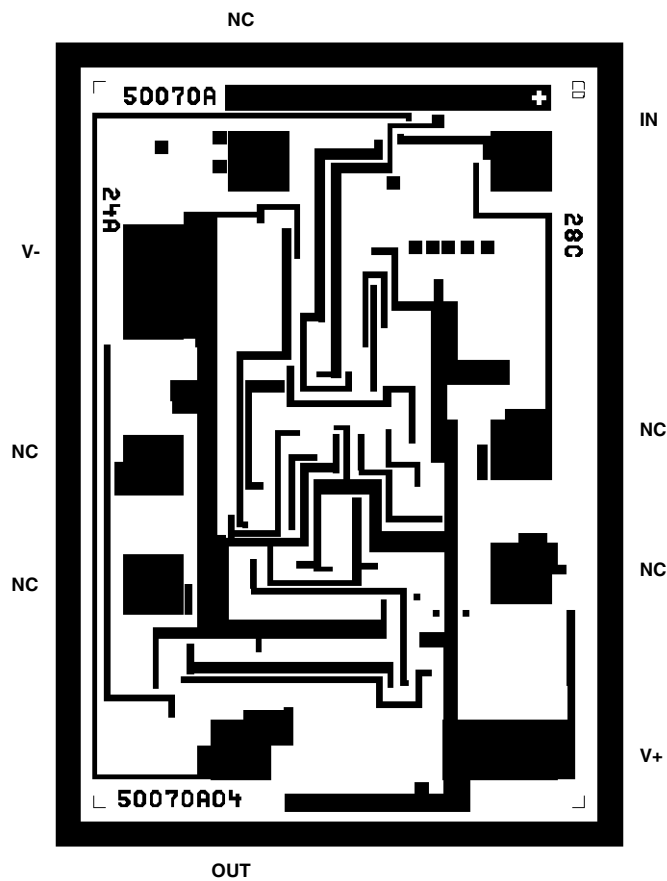

Small Outline Plastic Packages (SOIC)

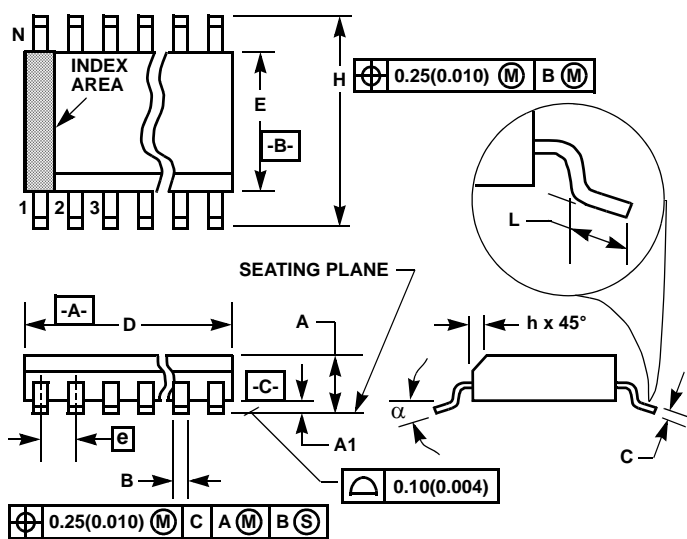

M8.15 (JEDEC MS-012-AA ISSUE C)
8 LEAD NARROW BODY SMALL OUTLINE PLASTIC PACKAGE

SYMBOL	INCHES		MILLIMETERS		NOTES
	MIN	MAX	MIN	MAX	
A	0.0532	0.0688	1.35	1.75	-
A1	0.0040	0.0098	0.10	0.25	-
B	0.013	0.020	0.33	0.51	9
C	0.0075	0.0098	0.19	0.25	-
D	0.1890	0.1968	4.80	5.00	3
E	0.1497	0.1574	3.80	4.00	4
e	0.050 BSC		1.27 BSC		-
H	0.2284	0.2440	5.80	6.20	-
h	0.0099	0.0196	0.25	0.50	5
L	0.016	0.050	0.40	1.27	6
N	8		8		7
α	0°	8°	0°	8°	-

NOTES:

1. Symbols are defined in the "MO Series Symbol List" in Section 2.2 of Publication Number 95.
2. Dimensioning and tolerancing per ANSI Y14.5M-1982.
3. Dimension "D" does not include mold flash, protrusions or gate burrs. Mold flash, protrusion and gate burrs shall not exceed 0.15mm (0.006 inch) per side.
4. Dimension "E" does not include interlead flash or protrusions. Interlead flash and protrusions shall not exceed 0.25mm (0.010 inch) per side.
5. The chamfer on the body is optional. If it is not present, a visual index feature must be located within the crosshatched area.
6. "L" is the length of terminal for soldering to a substrate.
7. "N" is the number of terminal positions.
8. Terminal numbers are shown for reference only.
9. The lead width "B", as measured 0.36mm (0.014 inch) or greater above the seating plane, shall not exceed a maximum value of 0.61mm (0.024 inch).
10. Controlling dimension: MILLIMETER. Converted inch dimensions are not necessarily exact.

Rev. 1 6/05

All Intersil U.S. products are manufactured, assembled and tested utilizing ISO9000 quality systems. Intersil Corporation's quality certifications can be viewed at www.intersil.com/design/quality

Intersil products are sold by description only. Intersil Corporation reserves the right to make changes in circuit design, software and/or specifications at any time without notice. Accordingly, the reader is cautioned to verify that data sheets are current before placing orders. Information furnished by Intersil is believed to be accurate and reliable. However, no responsibility is assumed by Intersil or its subsidiaries for its use; nor for any infringements of patents or other rights of third parties which may result from its use. No license is granted by implication or otherwise under any patent or patent rights of Intersil or its subsidiaries.

For information regarding Intersil Corporation and its products, see www.intersil.com