

175649

# TV905 Powerfin - TO220 etc.

New version of TV1505  
 manufactured in tin plated  
 aluminium enabling  
 soldering to P.C.B.  
 TV905  $\theta = 18^\circ\text{C/W}$

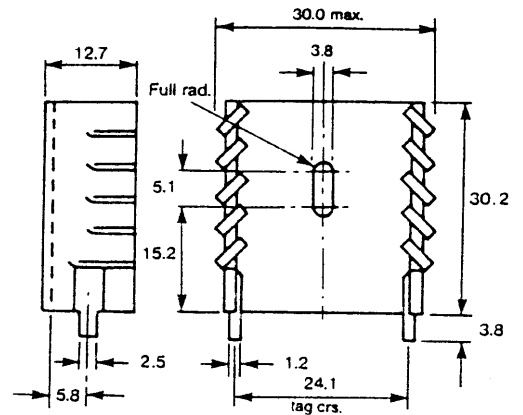
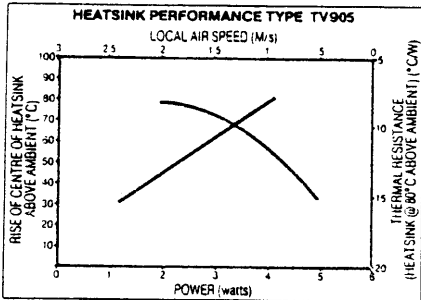

# SW Series for Plastic Power Devices

Powerful, versatile and solderable heatsink.  
 Economical of P.C.B. space. Ideal for switching  
 power supplies. Vertically mounted by pins with  
 device fixing holes to suit TO220, TO218, TO3P,  
 TO202 etc.

Also available without fixing holes using  
 clamping spring.

All patterns available without  
 solderable pins for screw  
 mounting etc.

Finish: Black anodised with  
 solderable pins.

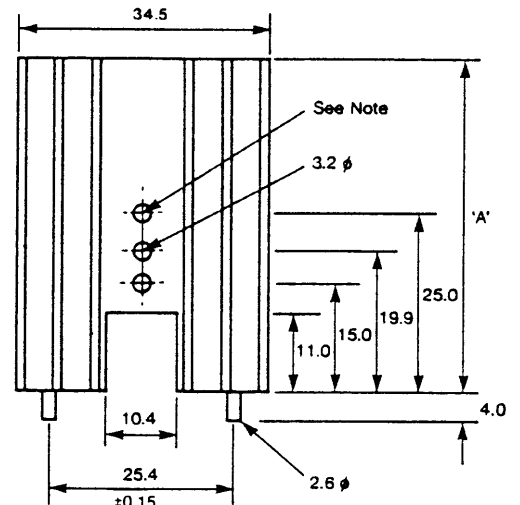
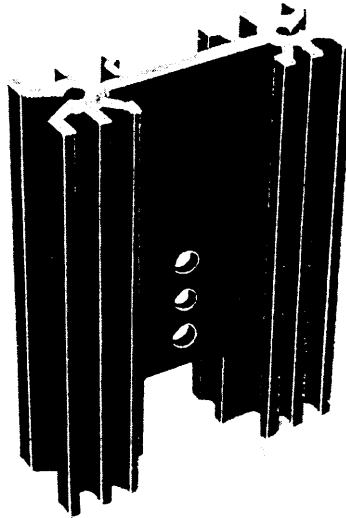
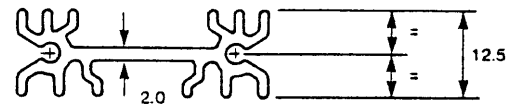

Note: This hole not present in SW25 models

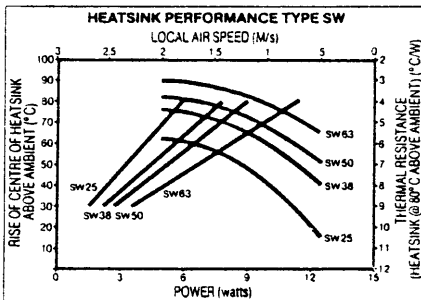

Length A	Part No	Holes	Cut-out	Thermal Rating $\theta = ^\circ\text{C/W}$
25	SW25-2	No	No	13
	SW25-4	Yes	No	
	SW25-6	Yes	Yes	
38	* SW38-2 *	No	No	10
	SW38-4	Yes	No	
	SW38-6	Yes	Yes	
50	SW50-2	No	No	8.6
	SW50-4	Yes	No	
	SW50-6	Yes	Yes	
63	SW63-2	No	No	6.8
	SW63-4	Yes	No	
	SW63-6	Yes	Yes	

TO218 etc. this side.  
 TO220 etc. opposite side.

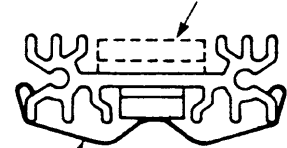

Retaining clip 5901

Use retaining clip 5901 with -1 and -2 variants

See also BW series for higher  
 power version.