

THYRISTOR MODULE

PK(PD,PE,KK)25HB

UL:E76102(M)

Power Thyristor/Diode Module **PK25HB** series are designed for various rectifier circuits and power controls. For your circuit application, following internal connections and wide voltage ratings up to 1,600V are available, and electrically isolated mounting base make your mechanical design easy.

- $I_{T(AV)}$ 25A, $I_{T(RMS)}$ 39A, I_{TSM} 500A
- di/dt 100 A/ μ s
- dv/dt 500V/ μ s

(Applications)

Various rectifiers
AC/DC motor drives
Heater controls
Light dimmers
Static switches

Internal Configurations

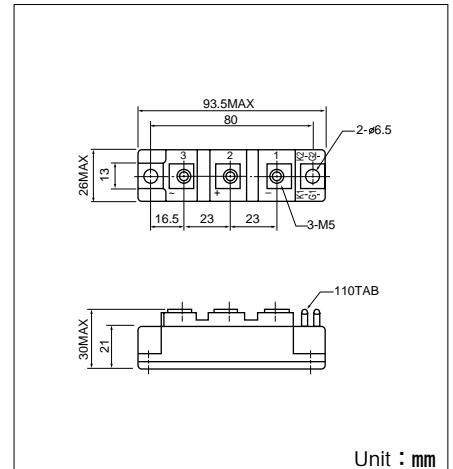
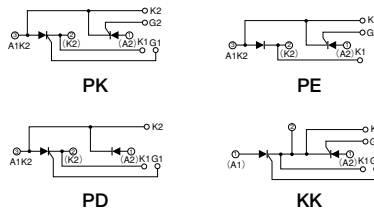

Maximum Ratings

Symbol	Item	Ratings				Unit
		PK25HB120 KK25HB120	PD25HB120 PE25HB120	PK25HB160 KK25HB160	PD25HB160 PE25HB160	
V_{RRM}	* Repetitive Peak Reverse Voltage		1200		1600	V
V_{RSM}	* Non-Repetitive Peak Reverse Voltage		1350		1700	V
V_{DRM}	Repetitive Peak Off-State Voltage		1200		1600	V

Symbol	Item	Conditions	Ratings	Unit	
$I_{T(AV)}$	* Average On-State Current	Single phase, half wave, 180° conduction, $T_c : 94^\circ\text{C}$	25	A	
$I_{T(RMS)}$	* R.M.S. On-State Current	Single phase, half wave, 180° conduction, $T_c : 94^\circ\text{C}$	39	A	
I_{TSM}	* Surge On-State Current	1/2 cycle, 50Hz/60Hz, peak Value, non-repetitive	450/500	A	
I^2t	* I^2t	Value for one cycle of surge current	1000	A ² S	
P_{GM}	Peak Gate Power Dissipation		10	W	
$P_{G(AV)}$	Average Gate Power Dissipation		1	W	
I_{FGM}	Peak Gate Current		3	A	
V_{FGM}	Peak Gate Voltage (Forward)		10	V	
V_{RGM}	Peak Gate Voltage (Reverse)		5	V	
di/dt	Critical Rate of Rise of On-State Current	$I_G=100\text{mA}$, $T_j=25^\circ\text{C}$, $V_D=1/2V_{DRM}$, $dI_G/dt=0.1\text{A}/\mu\text{s}$	100	A/ μ s	
V_{ISO}	* Isolation Breakdown Voltage (R.M.S.)	A.C. 1minute	2500	V	
T_j	* Operating Junction Temperature		-40 to +125	°C	
T_{stg}	* Storage Temperature		-40 to +125	°C	
	Mounting Torque	Mounting (M6)	Recommended Value 2.5-3.9 (25-40)	4.7 (48)	N·m (kgf·cm)
		Terminal (M5)	Recommended Value 1.5-2.5 (15-25)	2.7 (28)	
	Mass			170	g

Electrical Characteristics

Symbol	Item	Conditions	Ratings	Unit
I_{DRM}	Repetitive Peak Off-State Current, max.	at V_{DRM} , single phase, half wave, $T_j=125^\circ\text{C}$	4	mA
I_{RRM}	* Repetitive Peak Reverse Current, max.	at V_{DRM} , single phase, half wave, $T_j=125^\circ\text{C}$	4	mA
V_{TM}	* Peak On-State Voltage, max.	On-State Current 75A, $T_j=125^\circ\text{C}$ Inst. measurement	1.60	V
I_{GT}/V_{GT}	Gate Trigger Current/Voltage, max.	$T_j=25^\circ\text{C}$, $I_T=1\text{A}$, $V_D=6\text{V}$	50/2	mA/V
V_{GD}	Non-Trigger Gate, Voltage, min.	$T_j=125^\circ\text{C}$, $V_D=1/2V_{DRM}$	0.25	V
t_{gt}	Turn On Time, max.	$I_T=25\text{A}$, $I_G=100\text{mA}$, $T_j=25^\circ\text{C}$, $V_D=1/2V_{DRM}$, $dI_G/dt=0.1\text{A}/\mu\text{s}$	10	μ s
dv/dt	Critical Rate of Rise of Off-State Voltage, min.	$T_j=125^\circ\text{C}$, $V_D=2/3V_{DRM}$, Exponential wave.	500	V/ μ s
I_H	Holding Current, typ.	$T_j=25^\circ\text{C}$	50	mA
I_L	Latching Current, typ.	$T_j=25^\circ\text{C}$	100	mA
$R_{th(j-c)}$	* Thermal Impedance, max.	Junction to case	0.80	°C/W

*mark : Thyristor and Diode part. No mark : Thyristor part

