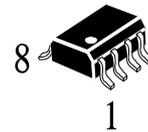

Switching Voltage Regulators

IK1509-xx

Features

- 3.3V, 5V, 12V, and adjustable output versions
- Adjustable version output voltage range, 1.23V to 18V \pm 3% max over line and load conditions
- Guaranteed 2A output load current
- Input voltage range up to 22V
- Built-in Switching Transistor on chip
- Excellent line and load regulation specifications
- 150kHz fixed frequency internal oscillator
- TTL shutdown capability
- Low power standby mode, IQ typically 80uA
- Thermal shutdown and current limit protection
- Bare chip is available

**SOP-8****IK1509** $T_A = -40^\circ$ to 125° C for all packages

Applications

- Simple high-efficiency step-down regulator
- On-card switching regulators
- Positive to negative converter

Description

The IK1509 series of regulators are monolithic integrated circuits that provide all the active functions for a step-down switching regulator, capable of driving a 2A load with excellent line and load regulation. These devices are available in fixed output voltages of 3.3V, 15V, 12V and an adjustable output version. Requiring a minimum number of external components, these regulators are simple to use.

The IK1509 series operates at a switching frequency of 150kHz. Other features include a guaranteed \pm 3% tolerance on output voltage under specified input voltage and output load conditions, and \pm 15% on the oscillator frequency. External shutdown is included, featuring typically 80uA standby current. Self protection features include a two stage frequency reducing current limit for output switch and an over temperature shutdown for complete protection under fault conditions. The over temperature shutdown level is about 145°C with 5°C hysteresis.

Absolute Maximum Rating
($T_A = 25^\circ\text{C}$)

Characteristic	Symbol	Value	Unit
Maximum Input Supply Voltage	V_I	+30	V
ON/OFF Pin Input Voltage	V_{IN}	$-0.3 \leq V \leq V_I$	V
Feedback Pin Voltage	V_{FB}	$-0.3 \leq V \leq V_I$	V
Output Voltage to Ground	V_{OUT}	-1	V
Power Dissipation	P_D	Internally limited	W
Storage Temperature Range	T_{stg}	-65 to +150	$^\circ\text{C}$
Operating Temperature Range	T_J	$-40 \leq T_J \leq +125$	$^\circ\text{C}$
Maximum Junction Temperature	T_{JMAX}	150	$^\circ\text{C}$
ESD Susceptibility (Human Body Model)	V_{ESD}	2	kV
Operating Supply Voltage	V_{OP}	4.5 to +25	V

Typical Application (Fixed Output Voltage Versions)

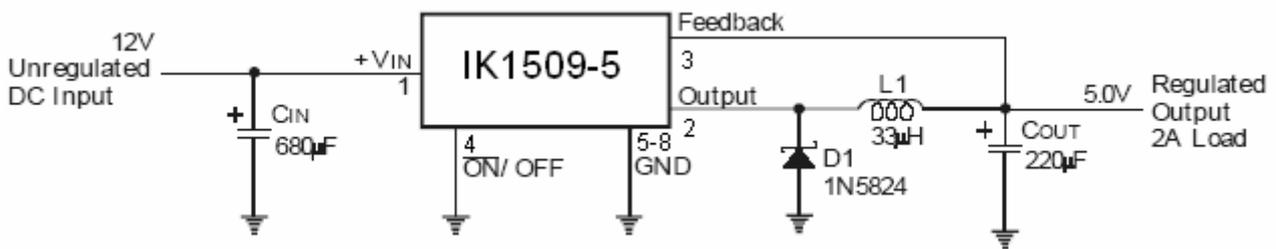

Pin Assignments

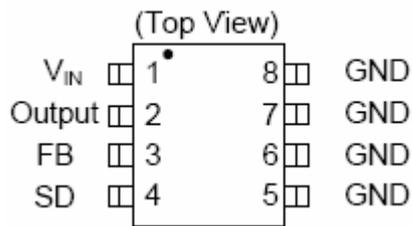

Pin Descriptions

Name	Description
V _{IN}	Operating voltage input
Output	Switching output
GND	Ground
FB	Output voltage feedback control
SD	ON/OFF Shutdown

Block Diagram

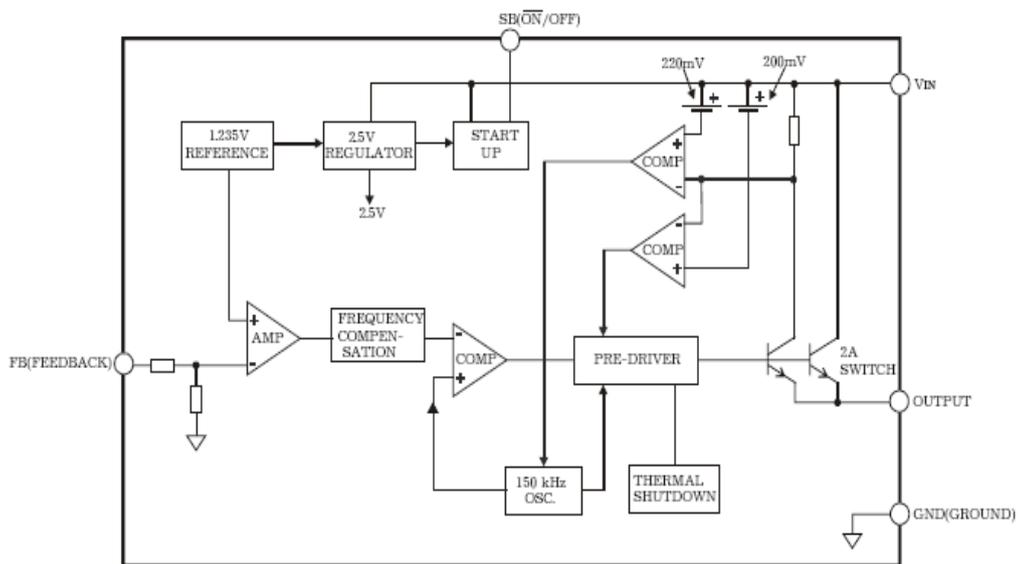

Electrical Characteristics

Unless otherwise specified, $T_J = 25^\circ\text{C}$, $V_{IN} = 12\text{V}$ for the 3.3V, 5V, and Adjustable version and $V_{IN} = 18\text{V}$ for the 12V version. $I_{LOAD} = 500\text{mA}$.

Characteristic	Symbol	Test Condition		Min	Typ	Max	Unit
Output Voltage	V_{OUT}	IK1509-3.3	$4.75\text{V} \leq V_{IN} \leq 22\text{V}$, $0.2\text{A} \leq I_{LOAD} \leq 2\text{A}$	3.20	3.3	3.40	V
		IK1509-5	$7\text{V} \leq V_{IN} \leq 22\text{V}$, $0.2\text{A} \leq I_{LOAD} \leq 2\text{A}$	4.85	5.0	5.15	
		IK1509-12	$15\text{V} \leq V_{IN} \leq 22\text{V}$, $0.2\text{A} \leq I_{LOAD} \leq 2\text{A}$	11.64	12.0	12.36	
Efficiency	η	IK1509-3.3	$V_{IN} = 12\text{V}$, $I_{LOAD} = 2\text{A}$		78		%
		IK1509-5	$V_{IN} = 12\text{V}$, $I_{LOAD} = 2\text{A}$		83		
		IK1509-12	$V_{IN} = 15\text{V}$, $I_{LOAD} = 2\text{A}$		90		
		IK1509-ADJ	$V_{IN} = 12\text{V}$, $I_{LOAD} = 2\text{A}$		76		%
Feedback Voltage	V_{FB}	IK1509-ADJ	$4.5\text{V} \leq V_{IN} \leq 22\text{V}$, $0.2\text{A} \leq I_{LOAD} \leq 2\text{A}$ V_{OUT} programmed for 3V	1.20	1.230	1.26	V
Feedback Bias Current	I_{FB}	IK1509-ADJ; $V_{FB} = 1.3\text{V}$			-10	-50	nA
Oscillator Frequency	F_{OSC}			127	150	173	kHz
Saturation Voltage	V_{SAT}	$I_{OUT} = 2\text{A}$ (Note 1,2)			1.10	1.3	V
Max Duty Cycle (ON) Max Duty Cycle (OFF)	DC	(Note 2)			100		%
		(Note 3)			0		
Current Limit	I_{CL}	Peak Current (Note 1,2)		2.4	3	3.7	A
Output Leakage Current	I_L	Output = 0V (Note 1,3)				50	μA
		Output = -1V, $V_{IN} = 22\text{V}$			1	10	mA
Quiescent Current	I_Q	(Note 3)			5	10	mA
Standby Quiescent Current	I_{STBY}	ON/OFF pin = 5V (OFF), $V_{IN} = 22\text{V}$			80	150	μA
ON/OFF Pin Logic Input Threshold Voltage	V_{IL}	Low (Regulator ON)			1.3	0.6	V
	V_{IH}	High (Regulator OFF)		2.0			
ON/OFF Pin Logic Input Current	I_H	$V_{LOGIC} = 2.5\text{V}$ (regulator OFF)			5	15	μA
	I_L	$V_{LOGIC} = 0.5\text{V}$ (regulator ON)				5	

Note 1: No elements connected to output pin.

Note 2: Feedback pin removed from output and connected to 0V to force the output transistor switch ON.

Note 3: Feedback pin removed from output and connected to 12V for the 3.3V, 5V, and the ADJ version, and 15V for the 12V version. To force the output transistor switch OFF.

Typical Performance Characteristics

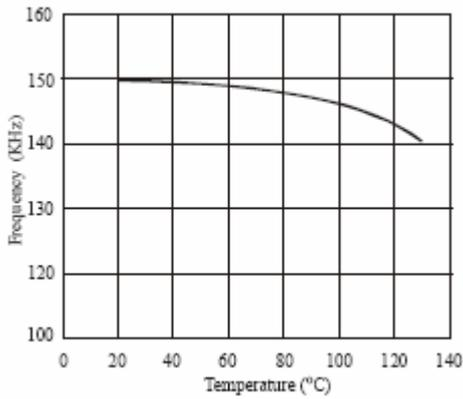

SWITCHING FREQUENCY

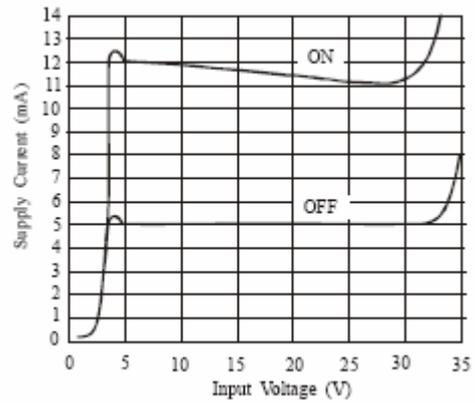

OPERATING QUIESCENT CURRENT

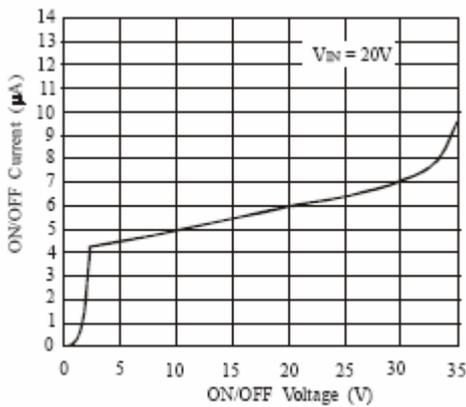

ON/OFF CURRENT

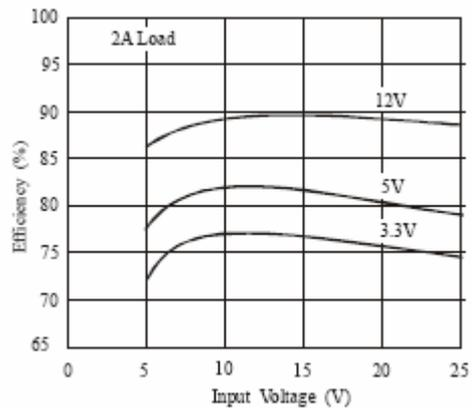

EFFICIENCY

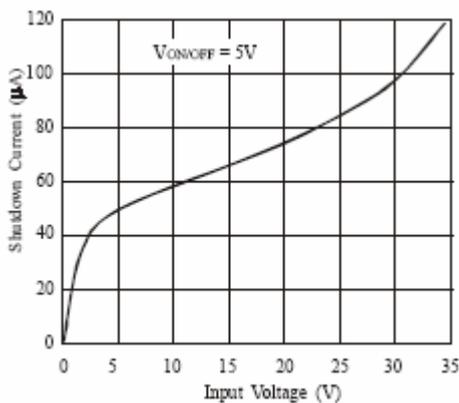

SHUTDOWN QUIESCENT CURRENT

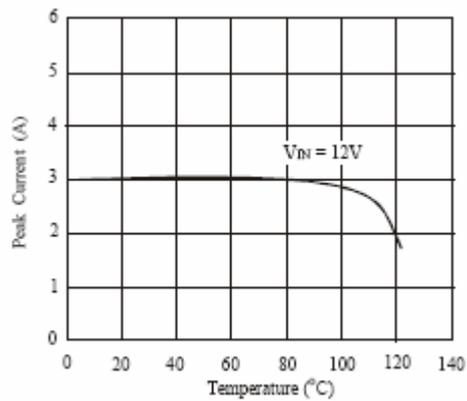

SWITCH CURRENT LIMIT

Package Dimensions

SOP-8

D SUFFIX SOIC
(MS - 012AA)

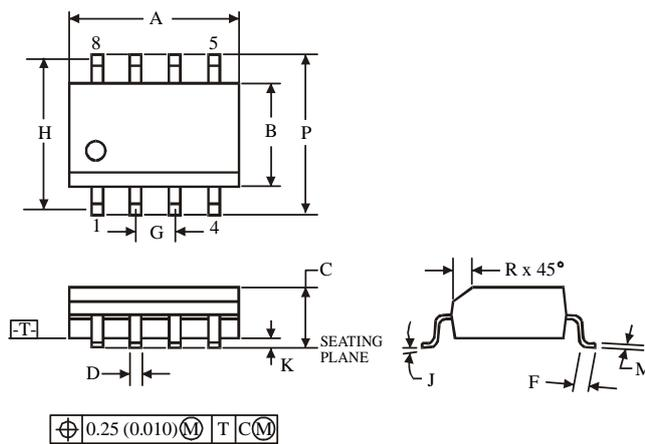
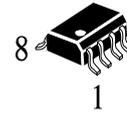

Symbol	Dimension, mm	
	MIN	MAX
A	4.8	5
B	3.8	4
C	1.35	1.75
D	0.33	0.51
F	0.4	1.27
G	1.27	
H	5.72	
J	0°	8°
K	0.1	0.25
M	0.19	0.25
P	5.8	6.2
R	0.25	0.5

NOTES:

1. Dimensions A and B do not include mold flash or protrusion.
2. Maximum mold flash or protrusion 0.15 mm (0.006) per side for A; for B - 0.25 mm (0.010) per side.