

Am29516/17 Family

16 x 16-Bit Parallel Multipliers

DISTINCTIVE CHARACTERISTICS

- High speed 16 x 16 multiplier
- Two's complement, unsigned or mixed operands
- Full product multiplexed at output
- Improved speed: 38ns clocked multiply (A devices)
Reduced power dissipation: 2W (L devices)
- Am29516 pin and functionally compatible with TRW MPY-16HJ — Am29517 optimized for microprogramming, single clock with register enables
- TTL I/O-single +5V supply — 64-pin package

GENERAL DESCRIPTION

The Am29516 and Am29517 are high speed parallel 16 x 16-bit multipliers utilizing internal ECL logic to generate a 32-bit product. 17-bit input registers are provided for the X and Y operands and their associated mode controls X_M and Y_M . These mode controls are used to specify the operands as two's complement or unsigned numbers.

At the output of the multiplier array, a format adjust control (FA), allows the user to select either a full 32-bit product or a left-shifted 31-bit product suitable for two's complement only.

Two 16-bit output registers are provided to hold the most and least significant halves of the product (MSP and LSP) as defined by FA. For asynchronous output, these registers may be made transparent by taking the feedthrough control (FT) high. A round control (RND) allows the rounding of the MSP; this control is registered, and is entered whenever either input register is clocked.

The two halves of the product may be routed to a 16-bit 3-state output port (P) via a multiplexer, and in addition, the

LSP is connected to the Y-input port through a separate three-state buffer.

The Am29516 X, Y, MSP and LSP registers have independent clocks (CLKX, CLKY, CLKM, CLKL). The output multiplexer control (MSPSEL) uses a pin which is a supply ground in the TRW MPY 16HJ. When this control is LOW the function is that of the MPY16HJ, thus allowing full compatibility.

The Am29517 differs in that it has a single clock input (CLK) and three register enables (\overline{ENX} , \overline{ENY} , \overline{ENP}) for the two input registers and the entire product, respectively. This facilitates the use of the part in microprogrammed systems. In both parts data is entered into the registers on the positive edge of the clock.

The Am29516A and Am29517A are higher speed versions of the Am29516 and Am29517, respectively, offering greater than 40% speed improvement while the Am29L516 and Am29L517 low-power versions consume only one-half the power of their standard power counterparts.

BLOCK DIAGRAM

Am29516/29516A/29L516

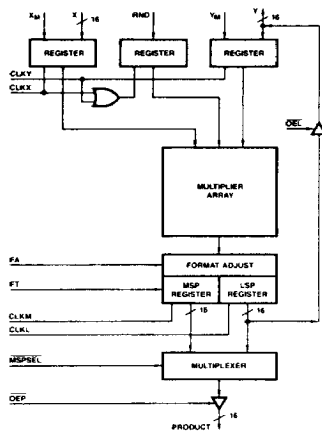

BD002840

Am29517/29517A/29L517

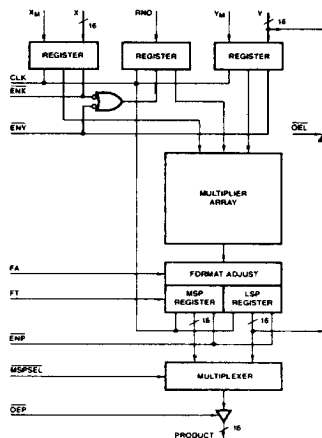

BD002850

03562C

RELATED PRODUCTS

Part No.	Description
Am29501	Multi-port Pipelined Processor
Am29526/27	Sine Function Generator
Am29528/29	Cosine Function Generator
Am29520/21	Pipeline Register
Am29540	Address Generator

CONNECTION DIAGRAM
Top View

D-64-3

L-68-3

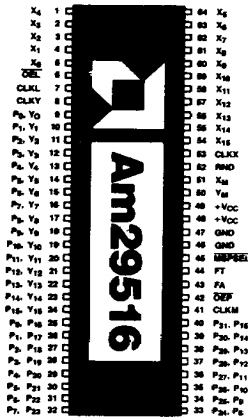

CDR04380

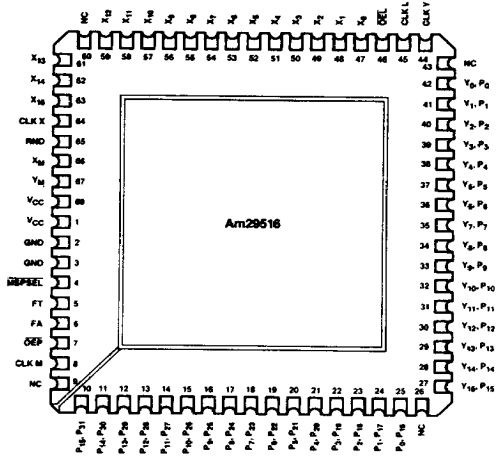

CDR04410

METALLIZATION AND PAD LAYOUT
Am29516A/29L516/29516

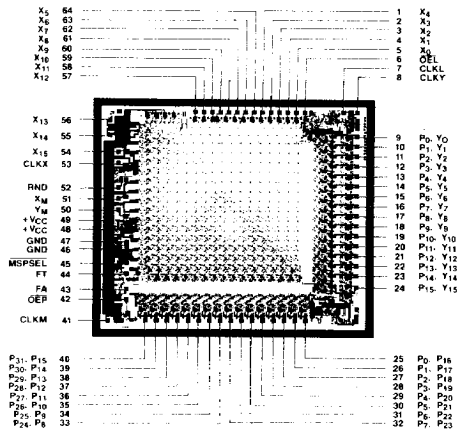

STANDARD DEVICE DIE SIZE: 250 X 222 MILS
'A' DEVICE DIE SIZE: 178 X 190 MILS
'L' DEVICE DIE SIZE: 250 X 222 MILS

CONNECTION DIAGRAM Top View

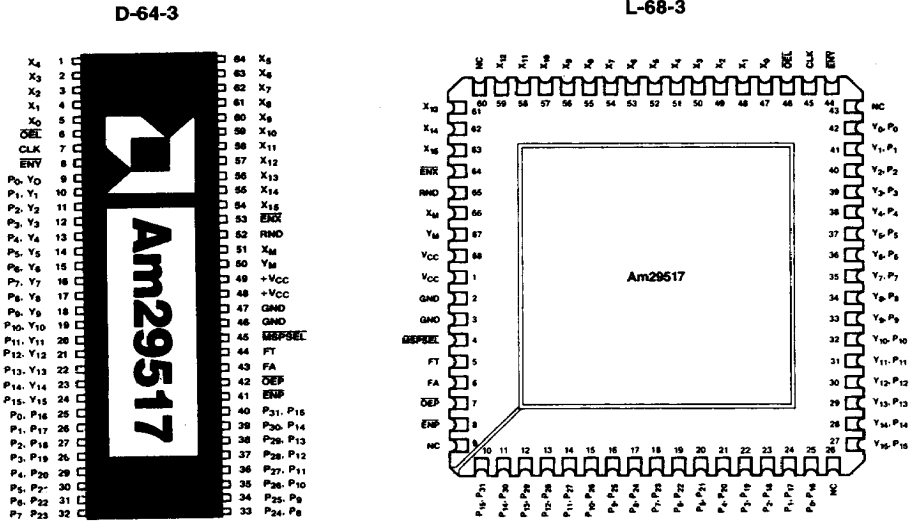

F-64-3S

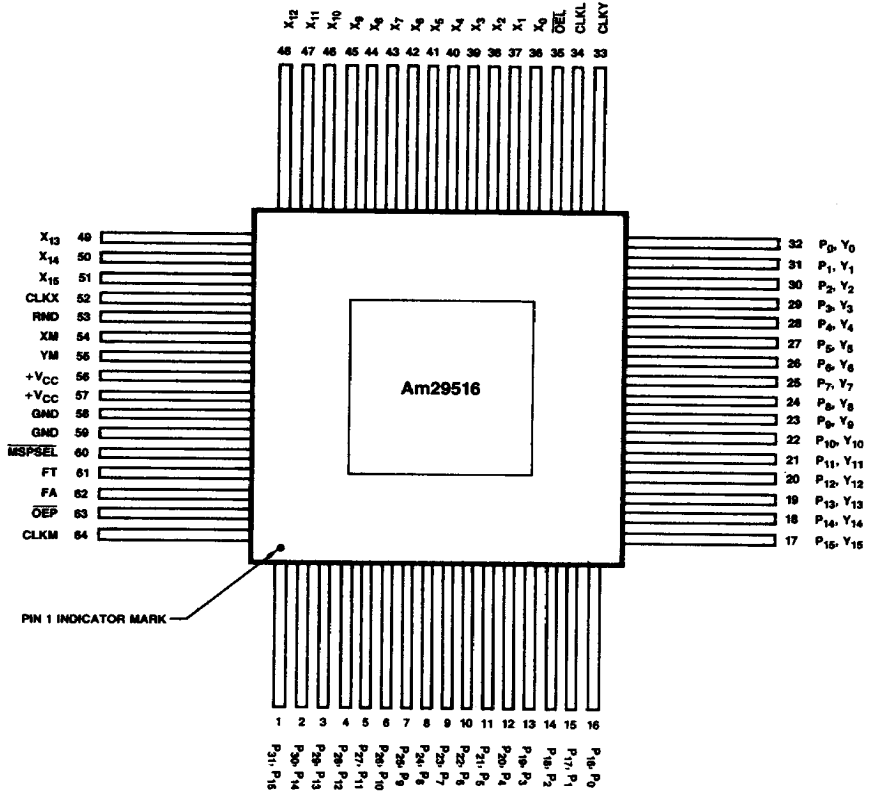

CDR04370

ORDERING INFORMATION

AMD products are available in several packages and operating ranges. The order number is formed by a combination of the following: Device number, speed option (if applicable), package type, operating range and screening option (if desired).

Am29516**P****C****B**

Screening Option
Blank - Standard processing
B - Burn-in (Note 1)

Temperature (see Operating Range)
C - Commercial (0 to +70°C)
M - Military (-55 to +125°C)

Package

D - TD-64-2 (64-pin CERDIP) -
with heat sink*
F - F-64-35 (64-pin flatpak)
L = L-68-3 (68-TERMINAL
Chip Carrier)
P = 64-pin Molded DIP

Speed Select

38ns = 29516A, 29517A
65ns = 29516, 29517
90ns = 29L516, 29L517

Device Type

29516, 29516A
29517, 29517A
29L516, 29L517

*TD-64-1 (64-pin CERDIP) without heat sink
for Low-Power versions

Note 1. 160-hour burn-in -
Heat sink parts: $T_A = 125^\circ\text{C}$
Non-heat sink parts: $T_A = 85^\circ\text{C}$

Valid Combinations

Am29516	DC, DCB, DMB - with heat sink FMB, LMB - without heat sink
Am29517 Am29516A Am29517A	DC, DCB, DMB - with heat sink LMB - without heat sink
Am29L516 Am29L517	PC, PCB, DC, DCB, DM, DMB, LMB without heat sink

Valid Combinations

Consult the AMD sales office in your area to determine if a device is currently available in the combination you wish.

PIN DESCRIPTION

*Pin No.	Name	I/O	Description
1-5, 54-64	X ₀ -X ₁₅	I	Multiplicand Data inputs.
9-24	Y ₀ -Y ₁₅ , P ₀ -P ₁₅	I/O	Multiplier Data inputs or Least Significant Product (LSP) output.
25-40	P ₁₆ -P ₃₁ , P ₀ -P ₁₅	O	MSP product port when MSPSEL is LOW. LSP product port when MSPSEL is HIGH.
51, 50	X _M , Y _M (TCX, TCY)**	I	Mode control inputs for each data word; LOW for unsigned data and HIGH for two's complement data.
43	FA(RS)**	I	Format adjust control selects either a full 32-bit product (HIGH) or a left shifted 31-bit product with the sign bit replicated in the LSP (LOW). This control is normally high, except for certain fractional two's complement applications. (See Multiplier output formats table.)
44	FT	I	Feedthrough control (HIGH) makes both MSP and LSP registers transparent.
45	MSPSEL	I	Selects either MSP (LOW) or LSP (HIGH) to be available at the product output port.
52	RND	I	Control for rounding the MSP. Adds a binary one to the most significant bit of the LSP for two's complement and unsigned numbers.
42	ÖEP (TRIM)**	I	Three-state enable for product output port.
6	ÖEL (TRIL)**	I	Three-state enable for routing LSP through Y input/output port.
Am29516 ONLY			
53, 8, 41, 7	CLKX CLKY CLKM CLKL	I	Register Clock, X ₁₅ -0, X _M , RND Register Clock, Y ₁₅ -0, Y _M , RND MSP Register Clock LSP Register Clock
Am29517 ONLY			
7, 53 8, 41	CLK ENX ENY ENP	I	Clock, All Registers Register Enable, X ₁₅ -0, X _M , RND Register Enable, Y ₁₅ -0, Y _M , RND Register Enable MSP, LSP

*DIP Configuration

**TRW MPY 16HJ pin designation

INPUT FORMATS
(All Devices)

Fractional Two's Complement Input Format

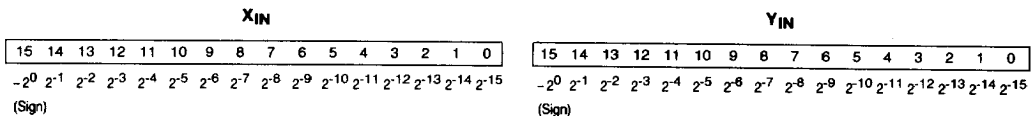
X_M, Y_M = 1

Integer Two's Complement Input Format

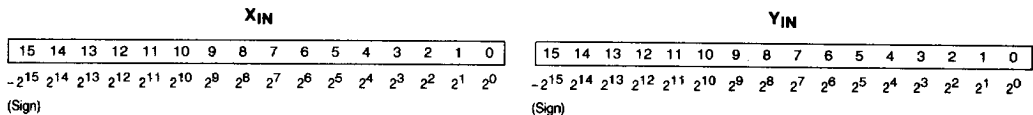
X_M, Y_M = 1

Unsigned Fractional Input Format

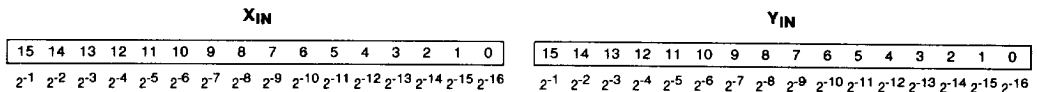
X_M, Y_M = 0

Unsigned Integer Input Format

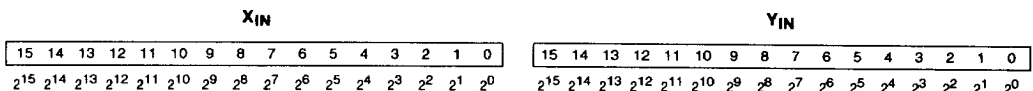
X_M, Y_M = 0

OUTPUT FORMATS (All Devices)

Fractional 2's Complement (Shifted)* Output

FA = 0

MSP

31	30	29	28	27	26	25	24	23	22	21	20	19	18	17	16
-2^0	2^{-1}	2^{-2}	2^{-3}	2^{-4}	2^{-5}	2^{-6}	2^{-7}	2^{-8}	2^{-9}	2^{-10}	2^{-11}	2^{-12}	2^{-13}	2^{-14}	2^{-15}

(Sign)

LSP

15	14	13	12	11	10	9	8	7	6	5	4	3	2	1	0
-2^0	2^{-16}	2^{-17}	2^{-18}	2^{-19}	2^{-20}	2^{-21}	2^{-22}	2^{-23}	2^{-24}	2^{-25}	2^{-26}	2^{-27}	2^{-28}	2^{-29}	2^{-30}

(Sign)

Fractional 2's Complement Output

FA = 1

MSP

31	30	29	28	27	26	25	24	23	22	21	20	19	18	17	16
-2^1	2^0	2^{-1}	2^{-2}	2^{-3}	2^{-4}	2^{-5}	2^{-6}	2^{-7}	2^{-8}	2^{-9}	2^{-10}	2^{-11}	2^{-12}	2^{-13}	2^{-14}

(Sign)

LSP

15	14	13	12	11	10	9	8	7	6	5	4	3	2	1	0
2^{-15}	2^{-16}	2^{-17}	2^{-18}	2^{-19}	2^{-20}	2^{-21}	2^{-22}	2^{-23}	2^{-24}	2^{-25}	2^{-26}	2^{-27}	2^{-28}	2^{-29}	2^{-30}

Integer Two's Complement Output

FA = 1

MSP

31	30	29	28	27	26	25	24	23	22	21	20	19	18	17	16
-2^{31}	2^{30}	2^{29}	2^{28}	2^{27}	2^{26}	2^{25}	2^{24}	2^{23}	2^{22}	2^{21}	2^{20}	2^{19}	2^{18}	2^{17}	2^{16}

(Sign)

LSP

15	14	13	12	11	10	9	8	7	6	5	4	3	2	1	0
2^{15}	2^{14}	2^{13}	2^{12}	2^{11}	2^{10}	2^9	2^8	2^7	2^6	2^5	2^4	2^3	2^2	2^1	2^0

Unsigned Fractional Output

FA = 1

MSP

31	30	29	28	27	26	25	24	23	22	21	20	19	18	17	16
2^{-1}	2^{-2}	2^{-3}	2^{-4}	2^{-5}	2^{-6}	2^{-7}	2^{-8}	2^{-9}	2^{-10}	2^{-11}	2^{-12}	2^{-13}	2^{-14}	2^{-15}	2^{-16}

LSP

15	14	13	12	11	10	9	8	7	6	5	4	3	2	1	0
2^{-17}	2^{-18}	2^{-19}	2^{-20}	2^{-21}	2^{-22}	2^{-23}	2^{-24}	2^{-25}	2^{-26}	2^{-27}	2^{-28}	2^{-29}	2^{-30}	2^{-31}	2^{-32}

Unsigned Integer Output

FA = 1

MSP

31	30	29	28	27	26	25	24	23	22	21	20	19	18	17	16
2^{31}	2^{30}	2^{29}	2^{28}	2^{27}	2^{26}	2^{25}	2^{24}	2^{23}	2^{22}	2^{21}	2^{20}	2^{19}	2^{18}	2^{17}	2^{16}

LSP

15	14	13	12	11	10	9	8	7	6	5	4	3	2	1	0
2^{15}	2^{14}	2^{13}	2^{12}	2^{11}	2^{10}	2^9	2^8	2^7	2^6	2^5	2^4	2^3	2^2	2^1	2^0

*In this format an overflow occurs in the attempted multiplication of the two's complement number 1.000...(-1) with itself, yielding a product of 1.000... or -1.

7

ABSOLUTE MAXIMUM RATINGS

Storage Temperature	-65 to +150°C
Supply Voltage to Ground Potential	
Continuous	-0.5 to +7.0V
DC Voltage Applied to Outputs For	
High Output State	-0.5V to +V _{CC} max
DC Input Voltage	-0.5 to +5.5V
DC Output Current, Into Outputs	30mA
DC Input Current	-30 to +5.0mA

Stresses above those listed under **ABSOLUTE MAXIMUM RATINGS** may cause permanent device failure. Functionality at or above these limits is not implied. Exposure to absolute maximum ratings for extended periods may affect device reliability.

OPERATING RANGES**Commercial (C) Devices**

Temperature

DIPs	T _A = 0°C to +70°C
Chip Carriers	T _C = 0°C to 85°C
Supply Voltage	+4.75V to +5.25V

Military (M) Devices

Temperature

Temperature	-55°C to +125°C
Supply Voltage	+4.5V to +5.5V

Operating ranges define those limits over which the functionality of the device is guaranteed.

DC CHARACTERISTICS over operating range unless otherwise specified
Am29516/29517

Parameters	Description	Test Conditions		Min	Typ (Note 1)	Max	Units
V _{OH}	Output HIGH Voltage	V _{CC} = MIN V _{IN} = V _{IH} or V _{IL}	I _{OH} = -0.4mA	2.4	2.7		Volts
V _{OL}	Output LOW Voltage	V _{CC} = MIN V _{IN} = V _{IH} or V _{IL}	I _{OL} = 4.0mA		.3	.5	Volts
V _{IH}	Input HIGH Level	Guaranteed input logical HIGH voltage for all inputs		2.0			Volts
V _{IL}	Input LOW Level	Guaranteed input logical LOW voltage for all inputs				.8	Volts
V _I	Input Clamp Voltage	V _{CC} = MIN, I _{IN} = -18mA				-1.5	Volts
I _{IL}	Input LOW Current	V _{CC} = MAX, V _{IN} = 0.4V				-0.4	mA
I _{IH}	Input HIGH Current	V _{CC} = MAX, V _{IN} = 2.4V				75	µA
I _I	Input HIGH Current	V _{CC} = MAX, V _{IN} = 5.5V				1	mA
I _{OZH}	Off State (High Impedance) Output Current	V _{CC} = MAX	Product			25	µA
I _{OZL}						-25	µA
I _{SC}	Output Short Circuit Current (Note 2)	V _{CC} = MAX	Y, Product			-30	mA
I _{CC}	Power Supply Current (Note 3)	COM'L Devices V _{CC} = MAX	T _A = +25°C		600		mA
			T _A = 0 to +70°C (Note 4)			800	
			T _A = +70°C (Note 4)			750	
			MIL Devices T _A = -55 to +125°C			900	
			T _A = +125°C			800	

- Notes: 1. Typical limits are at V_{CC} = 5.0V, +25°C ambient and maximum loading.
 2. Not more than one output should be shorted at a time. Duration of the short circuit test should not exceed one second.
 3. OEP and OEL LOW with all product (MSP and LSP) bits LOW.
 4. Chip Carriers: T_C = 85°C.

DC CHARACTERISTICS over operating range unless otherwise specified
Am29516A/29L516/Am29517A/29L517

Parameters	Description	Test Conditions		Min	Typ (Note 1)	Max	Units	
V _{OH}	Output High Voltage	V _{CC} = MIN V _{IN} = V _{IH} or V _{IL}	I _{OH} = -0.4mA	2.4	2.7		Volts	
V _{OL}	Output LOW Voltage	V _{CC} = MIN V _{IN} = V _{IH} or V _{IL}	I _{OL} = 4.0mA		.3	.5	Volts	
V _{IH}	Input HIGH Level	Guaranteed input logical HIGH voltage for all inputs		2.0			Volts	
V _{IL}	Input LOW Level	Guaranteed input logical LOW voltage for all inputs				.8	Volts	
V _I	Input Clamp Voltage	V _{CC} = MIN, I _{IN} = -18mA				-1.5	Volts	
I _{IL}	Input LOW Current	V _{CC} = MAX, V _{IN} = 0.4V				-0.4	mA	
I _{IH}	Input HIGH Current	V _{CC} = MAX, V _{IN} = 2.4V				75	µA	
I _I	Input HIGH Current	V _{CC} = MAX, V _{IN} = 5.5V				1	mA	
I _{OZH}	Off State (High Impedance) Output Current	V _{CC} = MAX	Product				µA	
I _{OZL}	Off State (High Impedance) Output Current	V _{CC} = MAX	Product				µA	
I _{SC}	Output Short Circuit Current (Note 2)	V _{CC} = MAX	Y, Product				mA	
I _{CC}	Power Supply Current (Note 3)	COM'L Devices V _{CC} = MAX	V _O = 2.4V					mA
			V _O = 0.4V					
			T _A = +25°C	A Devices	600			
				L Devices	300			
		T _A = 0 to +70°C (Note 4)	A Devices		800			
			L Devices		400			
		T _A = +70°C (Note 4)	A Devices		750			
			L Devices		350			
MIL Devices V _{CC} = MAX	T _C = -55 to +125°C	A Devices	900					
		L Devices	440					
	T _{CC} = +125°C	A Devices	800					
		L Devices	350					

- Notes: 1. Typical limits are at V_{CC} = 5.0V, 25°C ambient and maximum loading.
 2. Not more than one output should be shorted at a time. Duration of the short circuit test should not exceed one second.
 3. OEP and OEL LOW with all product (MSP and LSP) bits LOW.
 4. Chip Carriers: T_C = 85°C.

SWITCHING CHARACTERISTICS over operating range unless otherwise specified (Note 1)
Am29516/29517

Parameters	Description	Test Conditions	Typ	COMMERCIAL		MILITARY		Units	
				Min	Max	Min	Max		
t _{MUC}	Unlocked Multiply Time	Load 1	50		85		95	ns	
t _{MC}	Clocked Multiply Time		40		65		75	ns	
t _S	X _i , Y _i , RND Set-up Time		10	20		25		ns	
t _H	X _i , Y _i , RND Hold Time		0	3		3		ns	
t _{PWH}	Clock Pulse Width High		10	15		15		ns	
t _{PWL}	Clock Pulse Width Low		10	15		15		ns	
t _{PDSEL}	MSPSEL to Product Out		20		30		35	ns	
t _{PDP}	Output Clock to P		20		30		35	ns	
t _{PDY}	Output Clock to Y		20		30		35	ns	
t _{PHZ}	OEP Disable Time		High to Z	12		23		28	ns
t _{PLZ}			Low to Z	15		23		28	ns
t _{PZH}	OEP Enable Time		Z to High	25		32		35	ns
t _{PZL}			Z to Low	25		32		35	ns
t _{PHZ}	OEL Disable Time	High to Z	12		23		28	ns	
t _{PLZ}		Low to Z	15		23		28	ns	
t _{PZH}	OEL Enable Time	Z to High	25		32		35	ns	
t _{PZL}		Z to Low	25		32		35	ns	
t _S	Clock Enable Set-up Time (Am29517 Only)	Load 1	5	10		15		ns	
t _H	Clock Enable Hold Time (Am29517 Only)		0	3		3		ns	
t _{HCL}	Clock Low Hold Time CLKXY Relative to CLKML (See Note 2) (Am29516 Only)		0	0		0		ns	

- Notes: 1. Switching Characteristics are measured and guaranteed for T_A as specified with 200 Lf/min flowing across the device.
 2. To ensure that the correct product is entered in the output registers, new data may not be entered into the input registers before the output registers have been clocked.

7

SWITCHING CHARACTERISTICS over operating range unless otherwise specified (Note 1)
Am29L516/29L517

Parameters	Description		Test Conditions	Typ	COMMERCIAL		MILITARY*		Units		
					Min	Max	Min	Max			
t _{MUC}	Unclocked Multiply Time		Load 1	90		120		135	ns		
t _{MC}	Clocked Multiply Time			70		90		100	ns		
t _S	X _i , Y _i , RND Set-up Time				25		25		ns		
t _H	X _i , Y _i , Hold Time				0		0		ns		
t _H	RND Hold Time				3		3		ns		
t _{PDH}	Clock Pulse Width High				20		20		ns		
t _{PWL}	Clock Pulse Width Low				20		20		ns		
t _{PDSEL}	MSPSEL to Product Out				25		35		40	ns	
t _{PDP}	Output Clock to P				25		35		40	ns	
t _{PDY}	Output Clock to Y				25		35		40	ns	
t _{PHZ}	OEP Disable Time	High to Z		Load 2	20		30		35	ns	
t _{PLZ}		Low to Z			20		30		35	ns	
t _{PZH}	OEP Enable Time	Z to High	25			35		40	ns		
t _{PZL}		Z to Low	25			35		40	ns		
t _{PHZ}	OEL Disable Time	High to Z	20			30		35	ns		
t _{PLZ}		Low to Z	20			30		35	ns		
t _{PZH}	OEL Enable Time	Z to High	25			35		40	ns		
t _{PZL}		Z to Low	25			35		40	ns		
t _S	Clock Enable Set-up Time (Am29L517 Only)		Load 1		10	15		20		ns	
t _H	Clock Enable Hold Time (Am29L517 Only)						3		5		ns
t _{HCL}	Clock Low Hold Time CLKXY Relative to CLKML (See Note 2) (Am29L516 Only)						0		0		ns

- Notes: 1. Switching Characteristics are measured and guaranteed for T_A as specified with 200 l/min flowing across the device.
 2. To ensure that the correct product is entered in the output registers, new data may not be entered into the input registers before the output registers have been clocked.

*PRELIMINARY

SWITCHING CHARACTERISTICS over operating range unless otherwise specified (Note 1)
Am29516A/517A

Parameters	Description	Test Conditions	Typ	COMMERCIAL		MILITARY		Units	
				Min	Max	Min	Max		
t _{MUC}	Unclocked Multiply Time	Load 1	45		58		65	ns	
t _{MC}	Clocked Multiply Time		30		38		42	ns	
t _S	X _i , Y _i Set-up Time		4	7		8		ns	
t _H	X _i , Y _i Hold Time		1	3		3		ns	
t _S	RND Set-up Time		4	7		4		ns	
t _H	RND Hold Time		1	3		1		ns	
t _{PWH}	Clock Pulse Width High		7	7		8		ns	
t _{PWL}	Clock Pulse Width Low		7	3		3		ns	
t _{PDSEL}	MSPSEL to Product Out		13		8		21	ns	
t _{PDP}	Output Clock to P				20		23	ns	
t _{PDY}	Output Clock to Y				20		23	ns	
t _{PHZ}	OEP Disable Time		High to Z			15		17	ns
t _{PLZ}			Low to Z			15		17	ns
t _{PZH}	OEP Enable Time		Z to High	20		23		25	ns
t _{PZL}			Z to Low	15		23		25	ns
t _{PHZ}	OEL Disable Time		High to Z	13		15		17	ns
t _{PLZ}			Low to Z	12		15		17	ns
t _{PZH}	OEL Enable Time	Z to High	20		23		25	ns	
t _{PZL}		Z to Low	15		23		25	ns	
t _S	Clock Enable Set-up Time (Am29517A Only)	Load 1		10		15		ns	
t _H	Clock Enable Hold Time (Am29517A Only)			3		3		ns	
t _{HCL}	Clock Low Hold Time CLKXY Relative to CLKML (See Note 2) (Am29516A Only)		-1					ns	

Notes: 1. Switching Characteristics are measured and guaranteed for T_A as specified with 200 L/min flowing across the device.
 2. To ensure that the correct product is entered in the output registers, new data may not be entered into the input registers before the output registers have been clocked.

Notes on Testing

Incoming test procedures on this device should be carefully planned, taking into account the high complexity and power levels of the part. The following notes may be useful:

1. Insure the part is adequately decoupled at the test head. Large changes in V_{CC} current as the device switches may cause erroneous function failures due to V_{CC} changes.
2. Do not leave inputs floating during any tests, as they may start to oscillate at high frequency.
3. Do not attempt to perform threshold tests at high speed. Following an input transition, ground current may change by as much as 400mA in 5–8ns. Inductance in the ground

cable may allow the ground pin at the device to rise by 100s of millivolts momentarily.

4. Use extreme care in defining input levels for AC tests. Many inputs may be changed at once, so there will be significant noise at the device pins and they may not actually reach V_{IL} or V_{IH} until the noise has settled. AMD recommends using V_{IL} ≤ 0.0V and V_{IH} ≥ 3.0V for AC tests.
5. To simplify failure analysis, programs should be designed to perform DC, Function, and AC tests as three distinct groups of tests.
6. To assist in testing, AMD offers complete documentation on our test procedures and, in most cases, can provide Fairchild Sentry programs under license.

SWITCHING TEST CIRCUIT

Normal Load (Load 1)

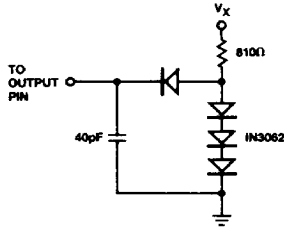

TCR01250

Three-State Delay Load (Load 2)

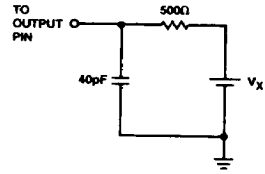

TCR01260

**TEST WAVEFORMS
(All Devices)**

Test	V_X	Output Waveform – Measurement Level
All t_{pDS}	V_{CC}	
t_{PHZ}	0.0V	
t_{PLZ}	2.6V	
t_{PZH}	0.0V	
t_{PZL}	2.6V	

WFR02780

**SETUP AND HOLD TIME
(All Devices)**

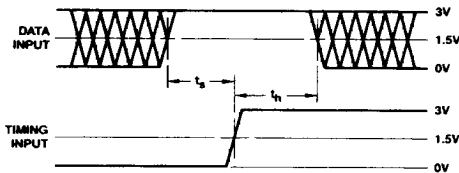

WFR02970

**PULSE WIDTH
(All Devices)**

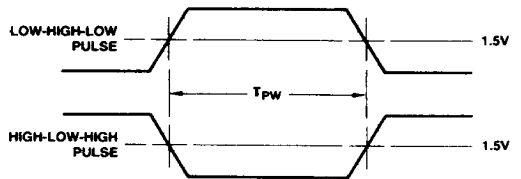

WFR02850

- Notes: 1. Diagram shown for HIGH data only. Output transition may be opposite sense.
2. Cross hatched area is don't care condition.

THREE-STATE TIMING DIAGRAM

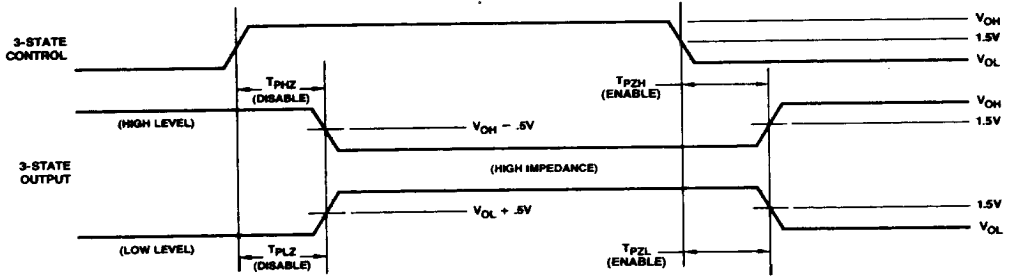

WFR02730

TIMING DIAGRAM Am29516/29516A/29L516

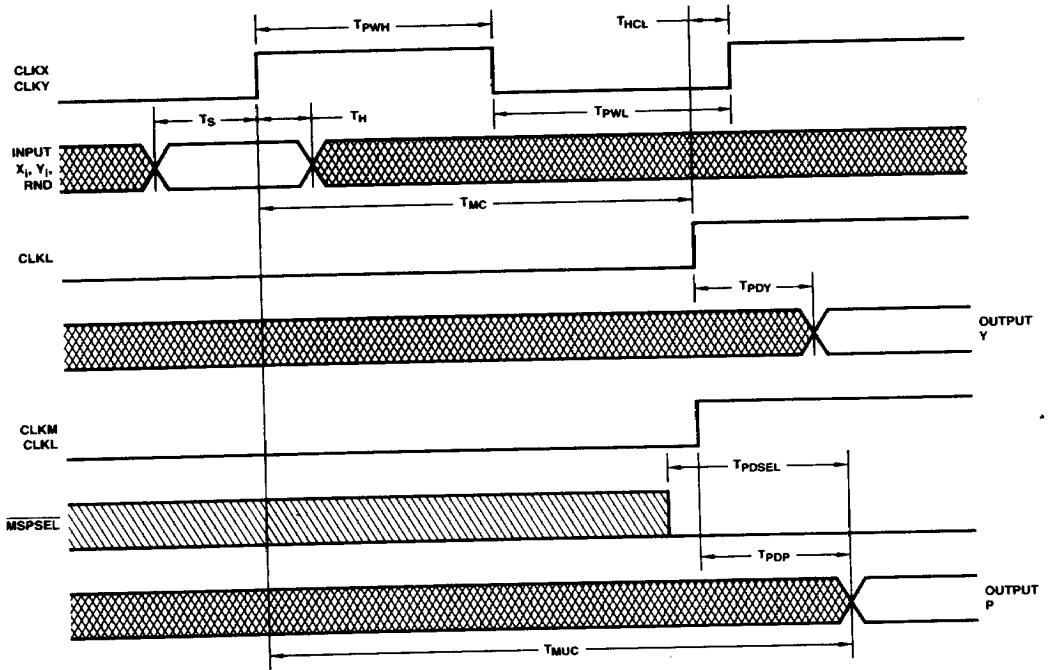

WFR02740

TIMING DIAGRAM
Am29517/29517A/29L517

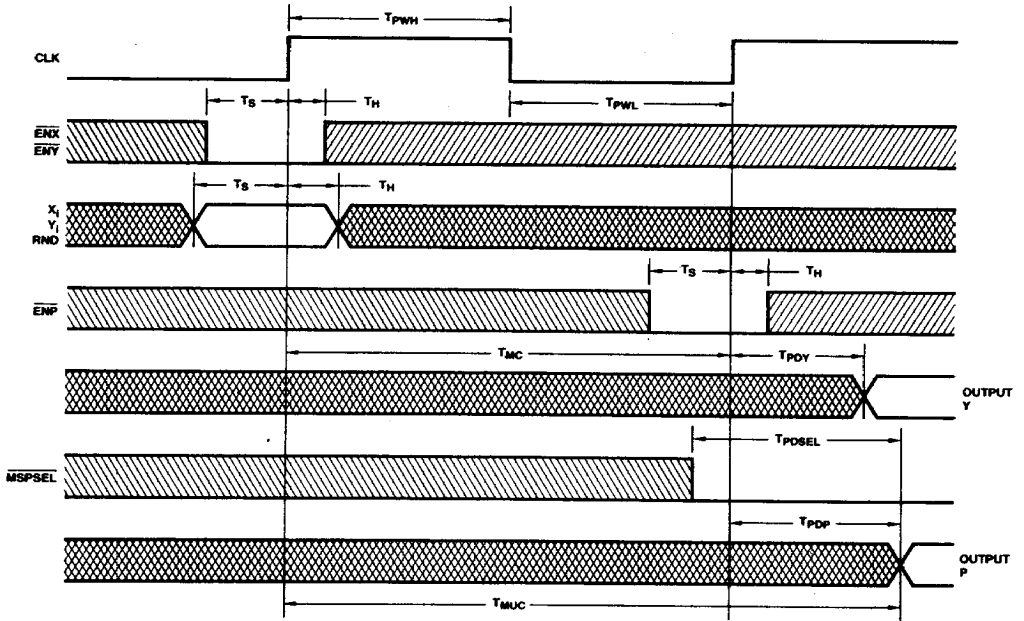

WFR02750

INPUT/OUTPUT CURRENT INTERFACE CONDITIONS
(All Devices)

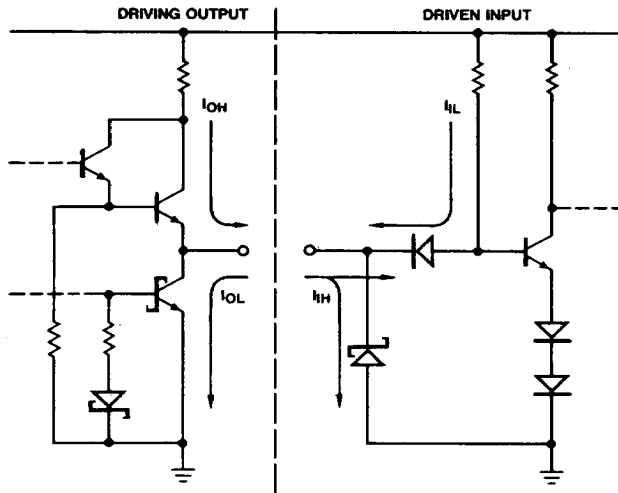

ICR00480

SIMPLIFIED TIMING DIAGRAM TYPICAL APPLICATION

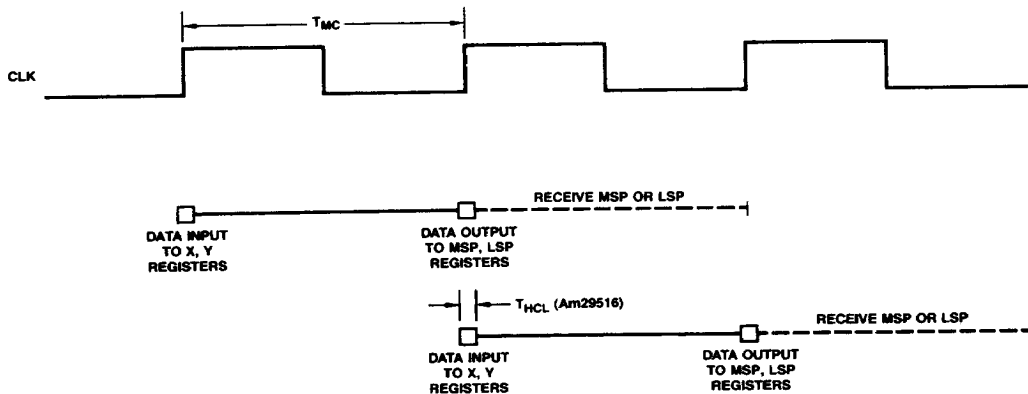

AFR01700