

8 PIN SOP 100 V BREAKDOWN VOLTAGE 2-CH OPTICAL COUPLED MOSFET

PS7211-2A

FEATURES

- **DUAL CHANNEL:**
1a + 1a output
- **LOW LED OPERATING CURRENT:**
 $I_F = 2 \text{ mA}$
- **DESIGNED FOR AC/DC SWITCHING LINE CHANGER**
- **SMALL AND THIN PACKAGE:**
8-pin SOP, Height = 2.1 mm
- **LOW OFFSET VOLTAGE**
- **AVAILABLE IN TAPE AND REEL**

DESCRIPTION

The PS7211-2A is a solid state relay containing GaAs LEDs on the light emitting side (input side) and MOSFETs on the output side. It is suitable for analog signal control because of its low offset and high linearity.

APPLICATIONS

- EXCHANGE EQUIPMENT
- MEASUREMENT EQUIPMENT
- FA/OA EQUIPMENT

ELECTRICAL CHARACTERISTICS ($T_A = 25^\circ\text{C}$)

PART NUMBER			PS7211-2A			
SYMBOLS	PARAMETERS	UNITS	MIN	TYP	MAX	
Diode	V_F	Forward Voltage, $I_F = 10 \text{ mA}$	V	1.2	1.4	
	I_R	Reverse Current, $V_R = 5 \text{ V}$	μA		5	
MOSFET	I_{Loff}	Off-state Leakage Current, $V_D = 100 \text{ V}$	μA	0.03	1.0	
	C_{out}	Output Capacitance, $V_D = 0 \text{ V}$, $f = 1 \text{ MHz}$	pF/ch	57		
Coupled	I_{Fon}	LED On-state Current, $I_L = 100 \text{ mA}$	mA		2.0	
	R_{ON1} R_{ON2}	On-state Resistance, $I_F = 10 \text{ mA}$, $I_L = 10 \text{ mA}$ $I_F = 10 \text{ mA}$, $I_L = 100 \text{ mA}$, $t \leq 10 \text{ ms}$	Ω	3.4	6.0	
	t_{ON}	Turn-on Time ¹ $I_F = 10 \text{ mA}$, $V_O = 5 \text{ V}$, $PW \geq 10 \text{ ms}$	ms		0.16	1.0
	t_{OFF}	Turn-off Time ¹			0.02	0.2
	R_{I-0}	Isolation Resistance, $V_{I-0} = 1.0 \text{ KV}$	Ω	10^9		
	C_{I-0}	Isolation Capacitance, $V = 0 \text{ V}$, $f = 1 \text{ MHz}$	pF/ch		0.4	

Note:

1. Test Circuit for Switching Time:

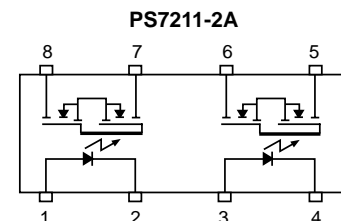
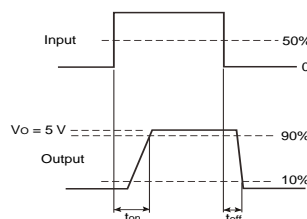
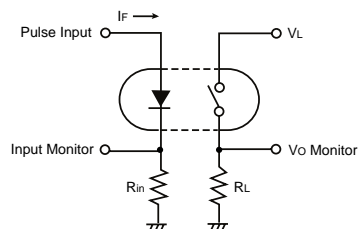

PS7211-2A

ABSOLUTE MAXIMUM RATINGS¹ (T_A = 25°C)

SYMBOLS	PARAMETERS	UNITS	RATINGS
Diode			
I _F	Forward Current (DC)	mA	50
V _R	Reverse Voltage	V	5
P _D	Power Dissipation	mW/ch	50
I _{FP}	Peak Forward Current ²	A	1
MOSFET			
V _L	Break Down Voltage	V	100
I _L	Continuous Load Current	mA	100
I _{LP}	Pulse Load Current ³ AC/DC Connection	mA	260
P _D	Power Dissipation	mW/ch	180
Coupled			
B _V	Isolation Voltage ⁴	V	1500
P _T	Total Power Dissipation	mW	460
T _{OP}	Operating Temperature	°C	-40 to +80
T _{STG}	Storage Temperature	°C	-40 to +100

Notes:

1. Operation in excess of any one of these parameters may result in permanent damage
2. PW = 100 μs, Duty Cycle 1%.
3. PW = 100 ms, 1 shot.
4. AC voltage for 1 minute at T_A = 25 °C, RH = 60 % between input and output.

RECOMMENDED OPERATING CONDITIONS (T_A = 25°C)

PART NUMBER		PS7211-2A			
SYMBOLS	PARAMETERS	UNITS	MIN	TYP	MAX
I _F	LED Operating Current	mA	2	10	20
V _F	LED Off Voltage	V	0		0.5

ORDERING INFORMATION

PART NUMBER	PACKAGE	PACKING STYLE
PS7211-2A	8 PIN SOP	Magazine case 45 pcs
PS7211-2A-F3		Embossed tape 1500 pcs/reel
PS7211-2A-F4		

OUTLINE DIMENSIONS (Units in mm)

PS7211-2A

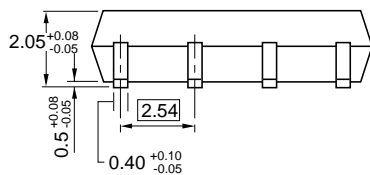
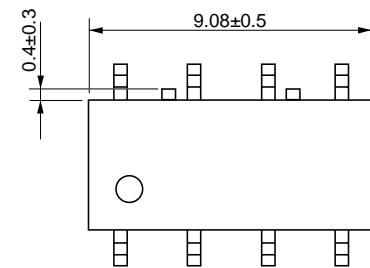

TOP VIEW

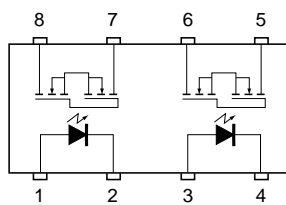

1. LED Anode
2. LED Cathode
3. LED Anode
4. LED Cathode
5. MOSFET
6. MOSFET
7. MOSFET
8. MOSFET

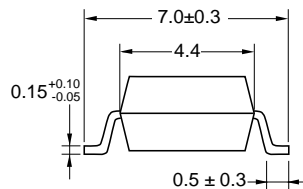

TYPICAL PERFORMANCE CURVES ($T_A = 25^\circ\text{C}$ unless otherwise specified)

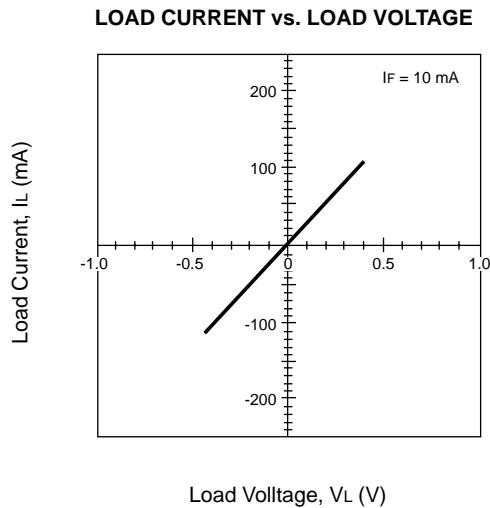
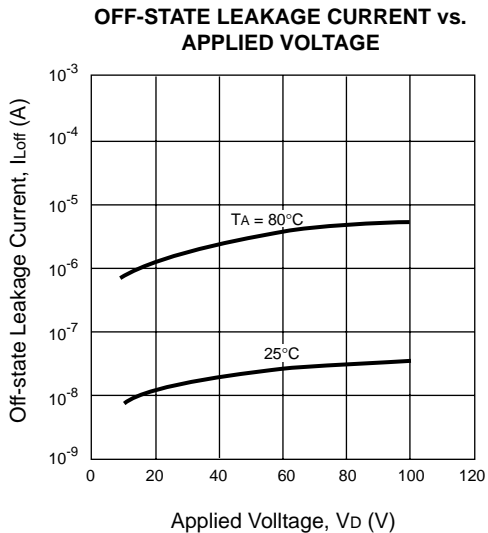
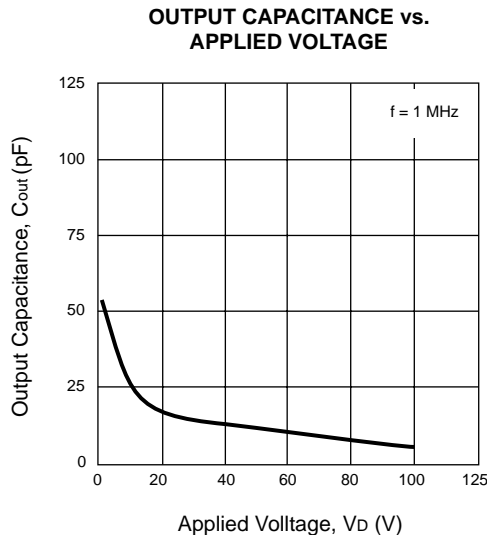
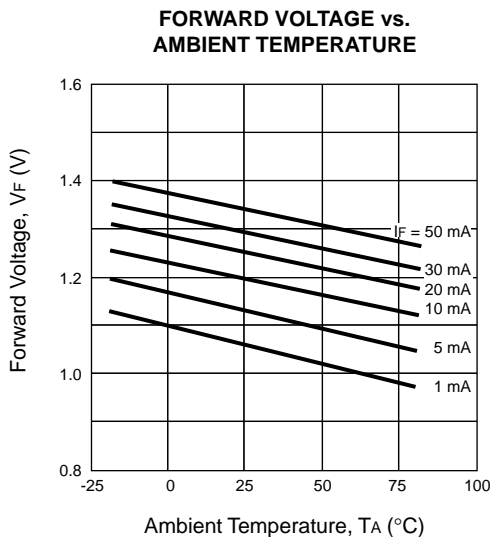
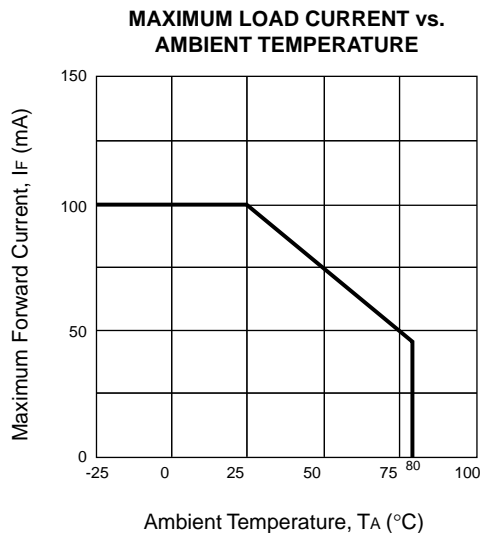
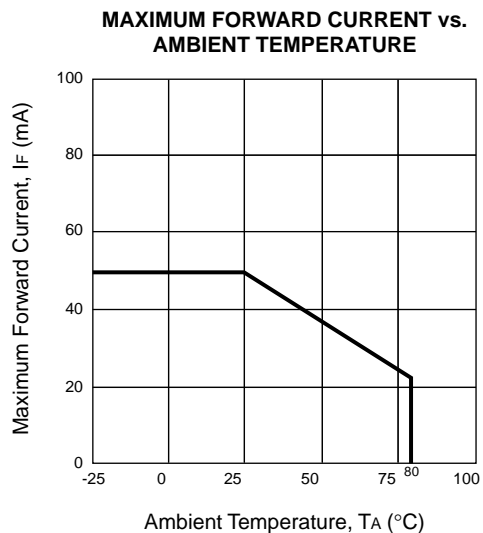

TYPICAL PERFORMANCE CURVES (TA = 25°C unless otherwise specified)

NORMALIZED ON-STATE RESISTANCE vs. AMBIENT TEMPERATURE

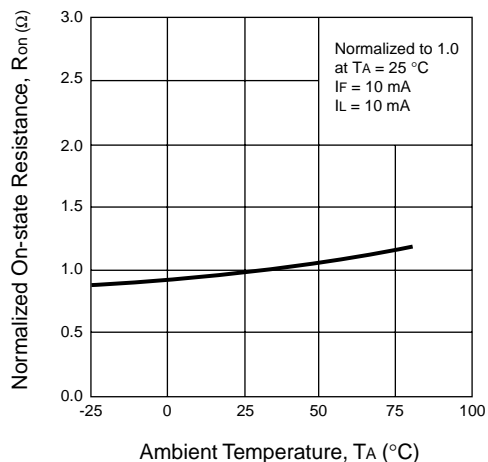

ON-STATE RESISTANCE DISTRIBUTION

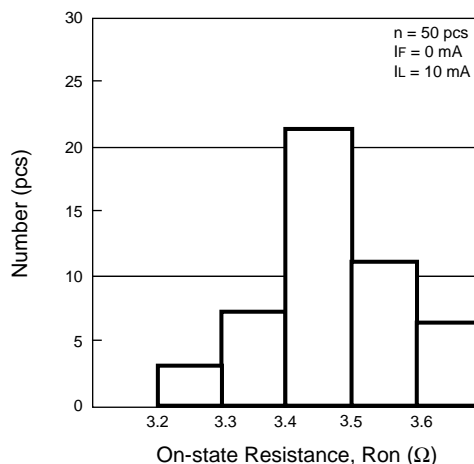

TURN-ON TIME vs. FORWARD CURRENT

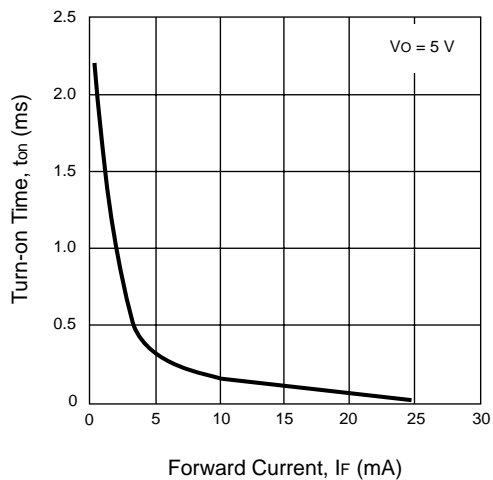

TURN-OFF TIME vs. FORWARD CURRENT

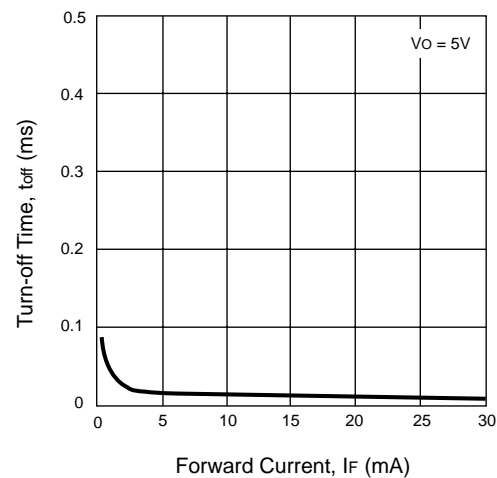

TURN-ON TIME DISTRIBUTION

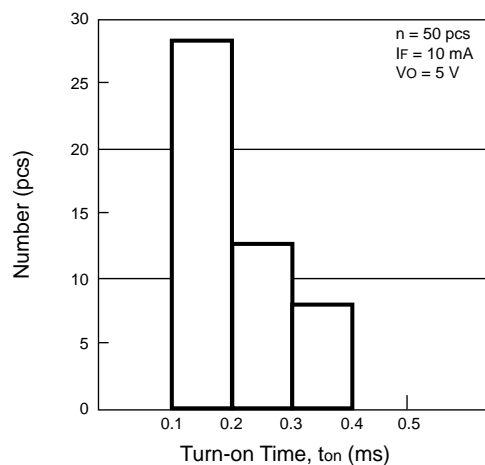

TURN-OFF TIME DISTRIBUTION

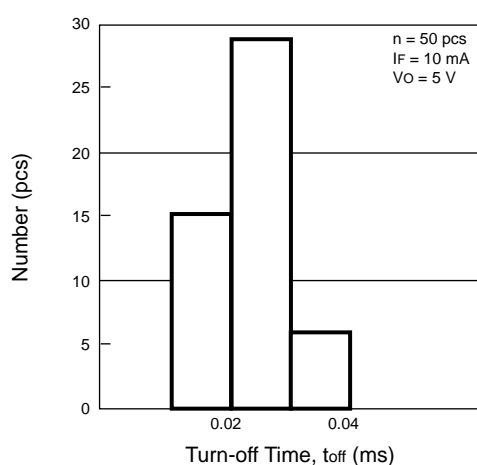

TYPICAL PERFORMANCE CURVES ($T_A = 25^\circ\text{C}$ unless otherwise specified)

NORMALIZED TURN-ON TIME vs. AMBIENT TEMPERATURE

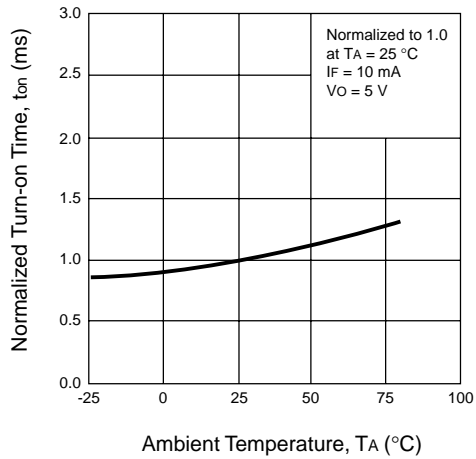

NORMALIZED TURN-OFF TIME vs. AMBIENT TEMPERATURE

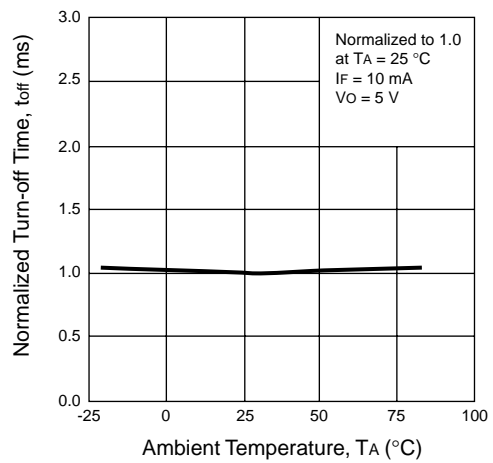

TAPING SPECIFICATIONS (Units in mm)

TAPE OUTLINE AND DIMENSIONS

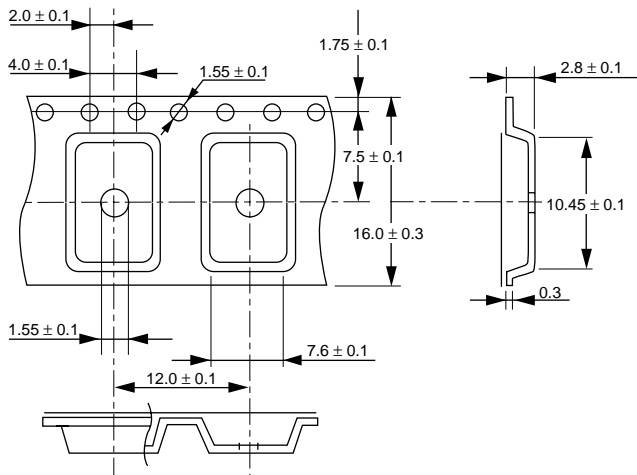

TAPE DIRECTION

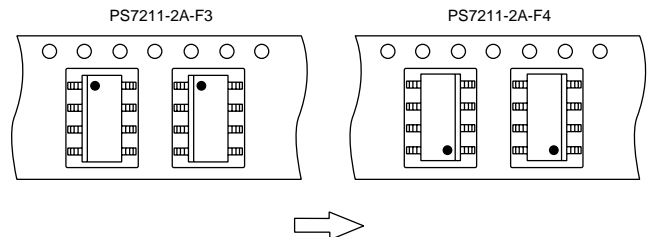

REEL OUTLINE and DIMENSIONS

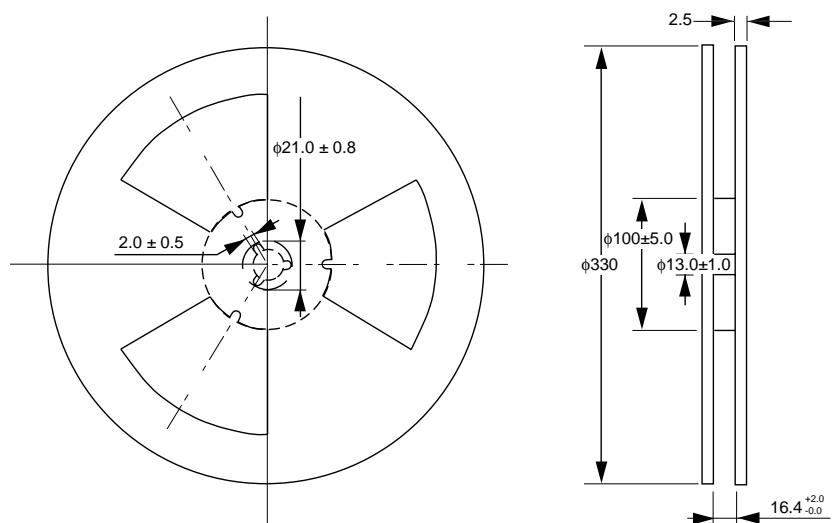

RECOMMENDED SOLDERING CONDITIONS

(1) Infrared reflow soldering

- Peak reflow temperature 235 °C or below (package surface temperature)
- Time of temperature higher than 210 °C 30 seconds or less
- Number of reflows Two
- Flux Rosin flux containing small amount of chlorine
(The flux with a maximum chlorine content of 0.2 Wt % is recommended.)

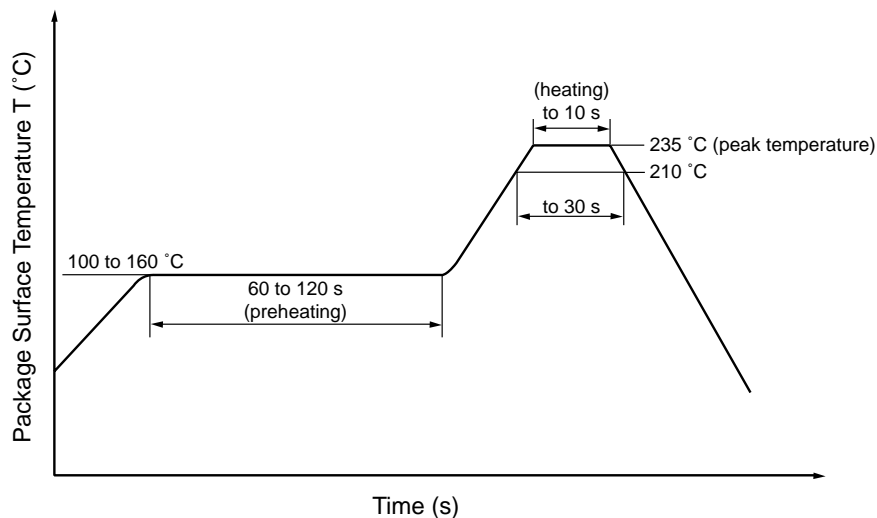

(2) Dip soldering

- Temperature 260 °C or below (molten solder temperature)
- Time 10 seconds or less
- Number of times One
- Flux Rosin flux containing small amount of chlorine
(The flux with a maximum chlorine content of 0.2 Wt % is recommended.)

(3) Cautions

- Fluxes
 - Avoid removing the residual flux with freon-based cleaning solvent.
- Avoid shorting between portion of frame and leads.

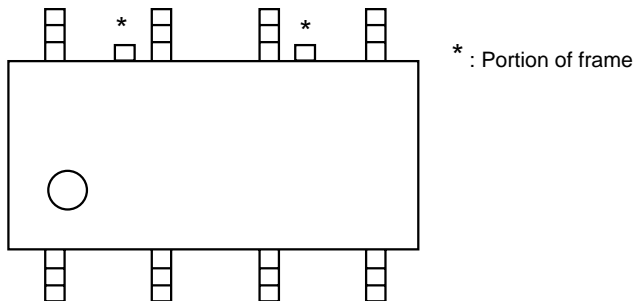

Life Support Applications

These NEC products are not intended for use in life support devices, appliances, or systems where the malfunction of these products can reasonably be expected to result in personal injury. The customers of CEL using or selling these products for use in such applications do so at their own risk and agree to fully indemnify CEL for all damages resulting from such improper use or sale.

EXCLUSIVE NORTH AMERICAN AGENT FOR NEC RF, MICROWAVE & OPTOELECTRONIC SEMICONDUCTORS

CEL CALIFORNIA EASTERN LABORATORIES • Headquarters • 4590 Patrick Henry Drive • Santa Clara, CA 95054-1817 • (408) 988-3500 • Telex 34-6393 • FAX (408) 988-0279
DATA SUBJECT TO CHANGE WITHOUT NOTICE

Internet: <http://WWW.CEL.COM>

10/08/2001