

# MABA-010125-TC1113



## RF 1:1 Transmission Line Transformer 4.5-3000 MHz

Rev. V4

### Features

- Surface mount
- Wide frequency range
- 1:1 impedance
- Lead Free
- RoHS\* Compliant and is 260°C reflow compatible.
- Available on Tape and Reel, reel quantity 2000

### Description

M/A-COM's MABA-010125-TC1113 is a RoHS compliant 1:1 RF transmission line transformer in a low cost, surface mount package. The windings of the MABA-010125-TC1113 are welded to the package substrate for improved reliability and to eliminate lead content. Ideally suited for high volume cellular and wireless application. Parts are packaged in tape & reel.

### Schematic

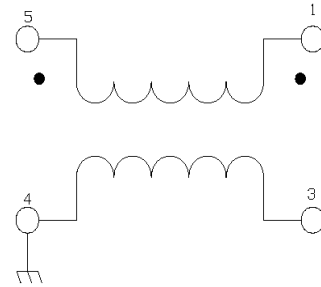

### Product Image



### Case-style Dimensions

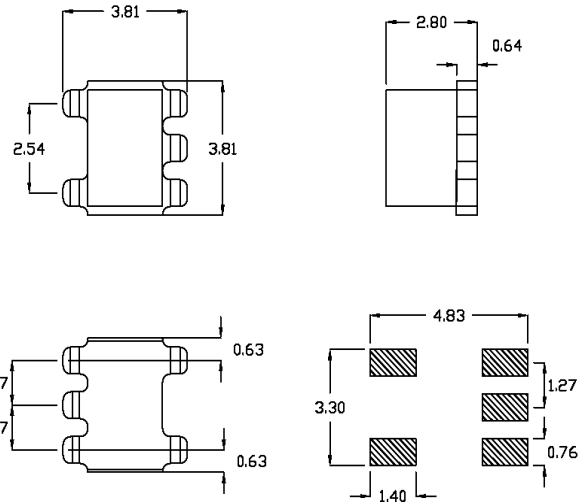

### Pin Configuration

Pin No.	Function
1	Secondary Dot
2	Not Connected
3	Secondary
4	Primary
5	Primary Dot

\* Dimensions are inches (millimeters)  $\pm 0.015$  (0.38) unless otherwise specified.

\* Restrictions on Hazardous Substances, European Union Directive 2002/95/EC.

**ADVANCED:** Data Sheets contain information regarding a product M/A-COM Technology Solutions is considering for development. Performance is based on target specifications, simulated results, and/or prototype measurements. Commitment to develop is not guaranteed.  
**PRELIMINARY:** Data Sheets contain information regarding a product M/A-COM Technology Solutions has under development. Performance is based on engineering tests. Specifications are typical. Mechanical outline has been fixed. Engineering samples and/or test data may be available. Commitment to produce in volume is not guaranteed.

• North America Tel: 800.366.2266 • Europe Tel: +353.21.244.6400  
 • India Tel: +91.80.43537383 • China Tel: +86.21.2407.1588

Visit [www.macomtech.com](http://www.macomtech.com) for additional data sheets and product information.

M/A-COM Technology Solutions Inc. and its affiliates reserve the right to make changes to the product(s) or information contained herein without notice.

# MABA-010125-TC1113



## RF 1:1 Transmission Line Transformer 4.5-3000 MHz

Rev. V4

### Electrical Specifications: $T_A = 25^\circ\text{C}$ , $Z_0 = 50\Omega$

Parameter	Test Conditions	Test Conditions	Units	Min	Typ	Max
RF Frequency	-	4.5 - 3000	MHz	-	-	-
Insertion Loss	-	4.5 - 1000	dB	-	0.3	1.0
		1000 - 2000	dB	-	1.5	2.0
		2000 - 3000	dB	-	2.8	-
Amplitude Unbalance	-	4.5 - 3000	dB	-	0.5	1.0
Phase Unbalance	-	4.5 - 3000	Degrees	-	5	20

### Absolute Maximum Ratings <sup>1,2</sup>

Parameter	Absolute Maximum
DC Power	250 mW
DC Current	50 mA
Operating Temperature	-40°C to +85°C
Storage Temperature	-55°C to +125°C

1. Exceeding any one or combination of these limits may cause permanent damage to this device.
2. M/A-COM does not recommend sustained operation near these survivability limits.

# MABA-010125-TC1113



## RF 1:1 Transmission Line Transformer 4.5-3000 MHz

Rev. V4

### Typical Performance Curves

**Insertion Loss**

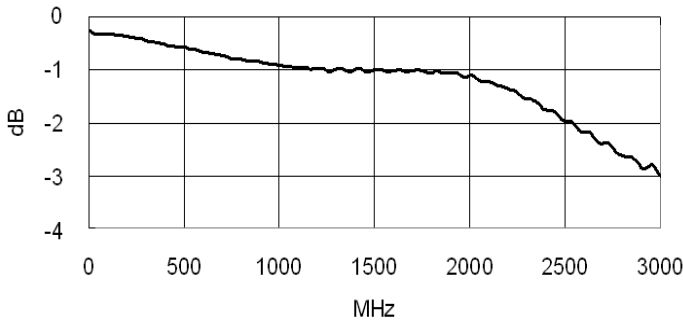

**Amplitude Unbalance**

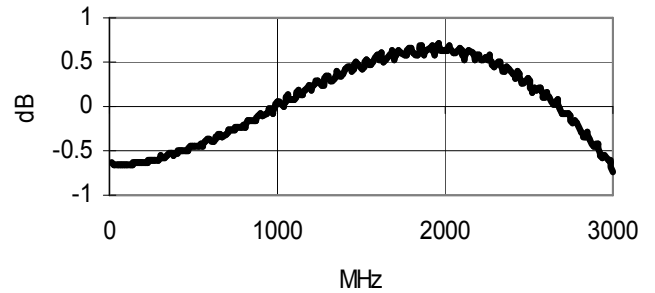

**Phase Unbalance**

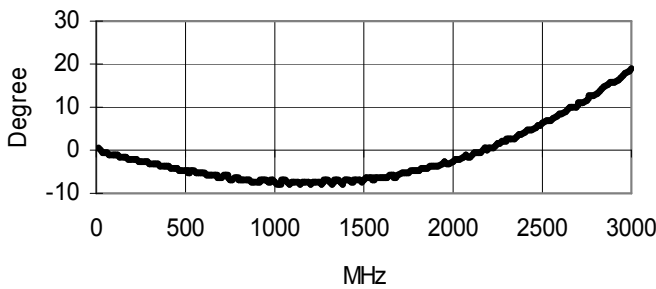

**Input Return Loss**

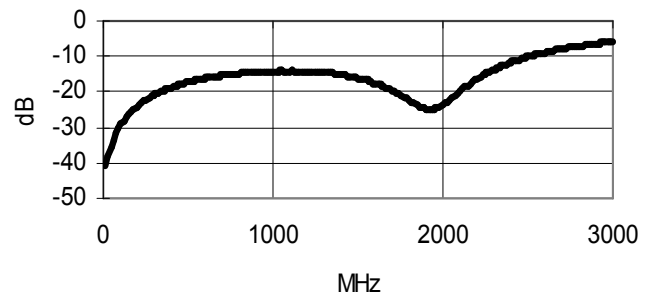

**ADVANCED:** Data Sheets contain information regarding a product M/A-COM Technology Solutions is considering for development. Performance is based on target specifications, simulated results, and/or prototype measurements. Commitment to develop is not guaranteed.  
**PRELIMINARY:** Data Sheets contain information regarding a product M/A-COM Technology Solutions has under development. Performance is based on engineering tests. Specifications are typical. Mechanical outline has been fixed. Engineering samples and/or test data may be available. Commitment to produce in volume is not guaranteed.

• **North America** Tel: 800.366.2266 • **Europe** Tel: +353.21.244.6400  
• **India** Tel: +91.80.43537383 • **China** Tel: +86.21.2407.1588

Visit [www.macomtech.com](http://www.macomtech.com) for additional data sheets and product information.

M/A-COM Technology Solutions Inc. and its affiliates reserve the right to make changes to the product(s) or information contained herein without notice.

# MABA-010125-TC1113



**RF 1:1 Transmission Line Transformer**  
**4.5-3000 MHz**

Rev. V4

## Tape & Reel Information

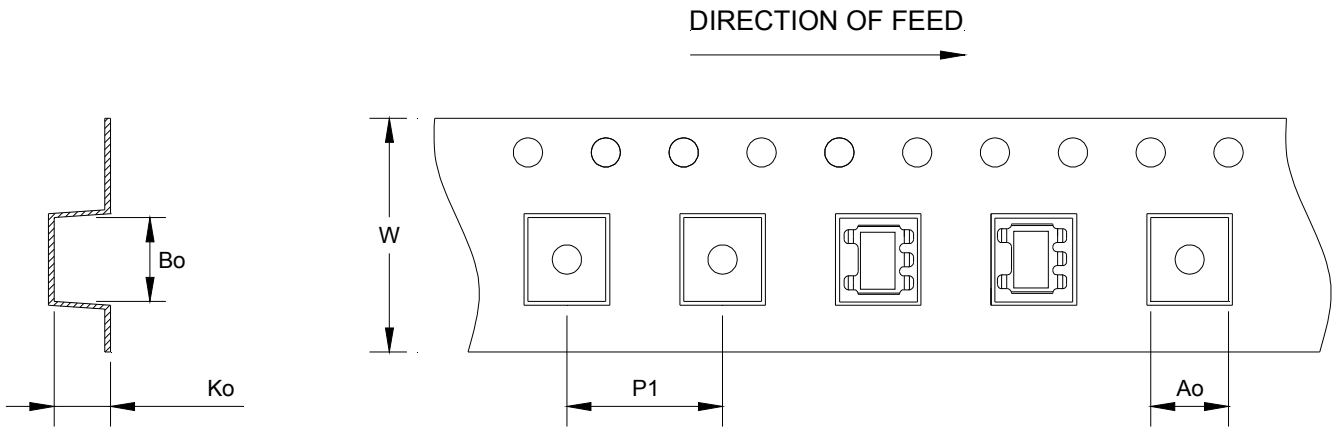

Item	Dimension
Ao	4.00mm +/-0.1mm
Bo	4.00mm +/-0.1mm
Ko	2.9mm +/-0.1mm
W	12.00mm +/-0.3mm
P1	8.00mm +/-0.1mm

## Ordering Information

Part Number	Package
MABA-010125-TC1113	Tape and Reel (2000 piece Reel)

**ADVANCED:** Data Sheets contain information regarding a product M/A-COM Technology Solutions is considering for development. Performance is based on target specifications, simulated results, and/or prototype measurements. Commitment to develop is not guaranteed.  
**PRELIMINARY:** Data Sheets contain information regarding a product M/A-COM Technology Solutions has under development. Performance is based on engineering tests. Specifications are typical. Mechanical outline has been fixed. Engineering samples and/or test data may be available. Commitment to produce in volume is not guaranteed.

• **North America** Tel: 800.366.2266 • **Europe** Tel: +353.21.244.6400  
 • **India** Tel: +91.80.43537383 • **China** Tel: +86.21.2407.1588  
 Visit [www.macomtech.com](http://www.macomtech.com) for additional data sheets and product information.

*M/A-COM Technology Solutions Inc. and its affiliates reserve the right to make changes to the product(s) or information contained herein without notice.*