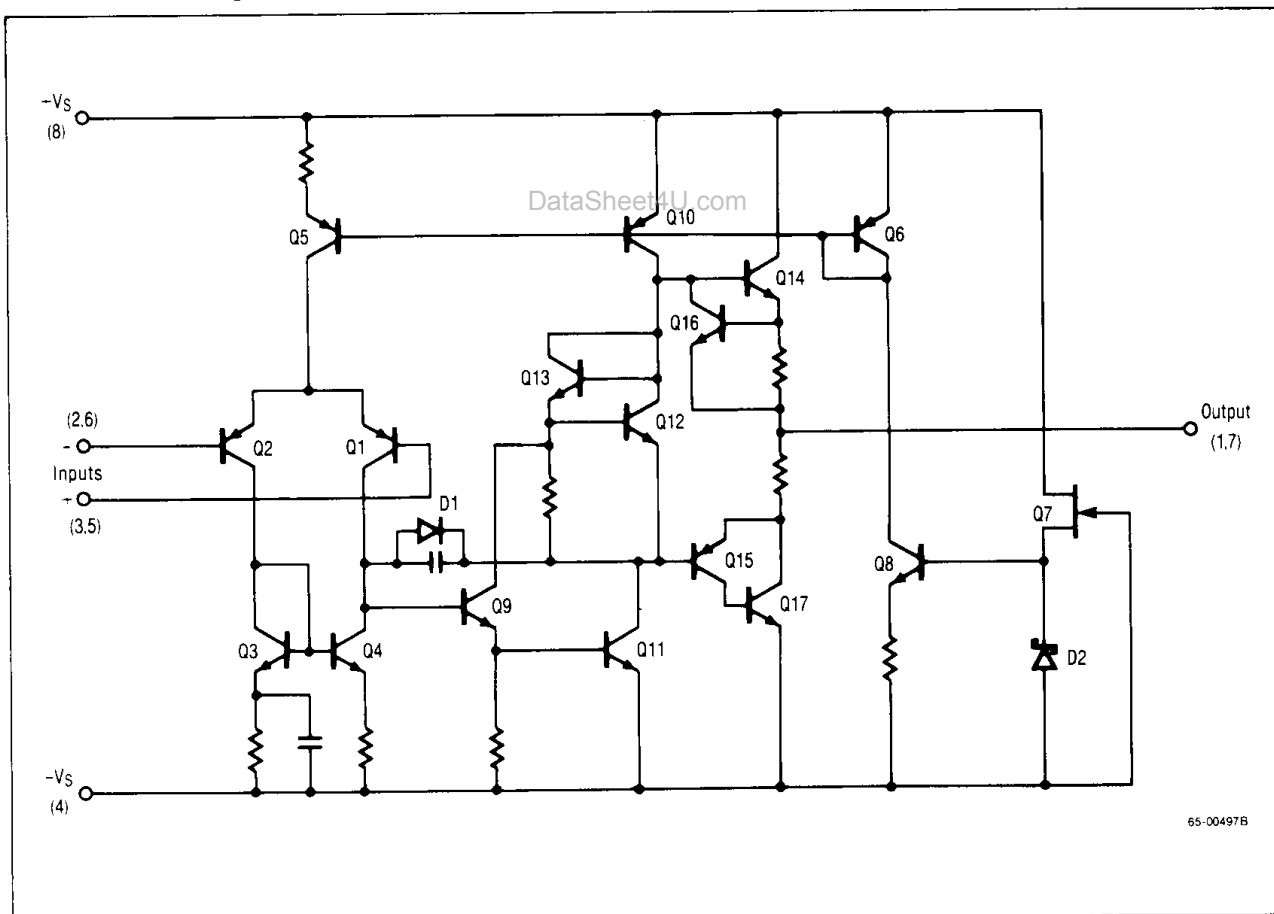

Raytheon**High Output Current
Dual Operational Amplifier****RC4556****Features**

- Unity gain bandwidth — 8.0MHz
- Drives $\pm 10.5\text{V}$ min into 150Ω ($\pm 10\text{mA}$)
- Slew rate — $3.0\text{V}/\mu\text{S}$
- Current drain per amplifier — 4.5mA
- Input offset voltage — 0.5mV
- Input offset current — 5.0nA
- Input bias current — 180nA
- $10\text{nV}/\sqrt{\text{Hz}}$ noise at 1kHz
- Unity gain frequency compensated

Description

The 4556 integrated circuit is a high-gain, high output current dual operational amplifier capable of driving $\pm 70\text{mA}$ into 150Ω loads ($\pm 10.5\text{V}$ output voltage). The 4556 combines many of the features of the popular 4558 as well as having the capability of driving 150Ω loads. In addition, the wide bandwidth, low noise, high slew rate and low distortion of the 4556 make it ideal for many audio, telecommunications and instrumentation applications.

Schematic Diagram (1/2 Shown)

RC4556 High Output Current Dual Operational Amplifier

Connection Information

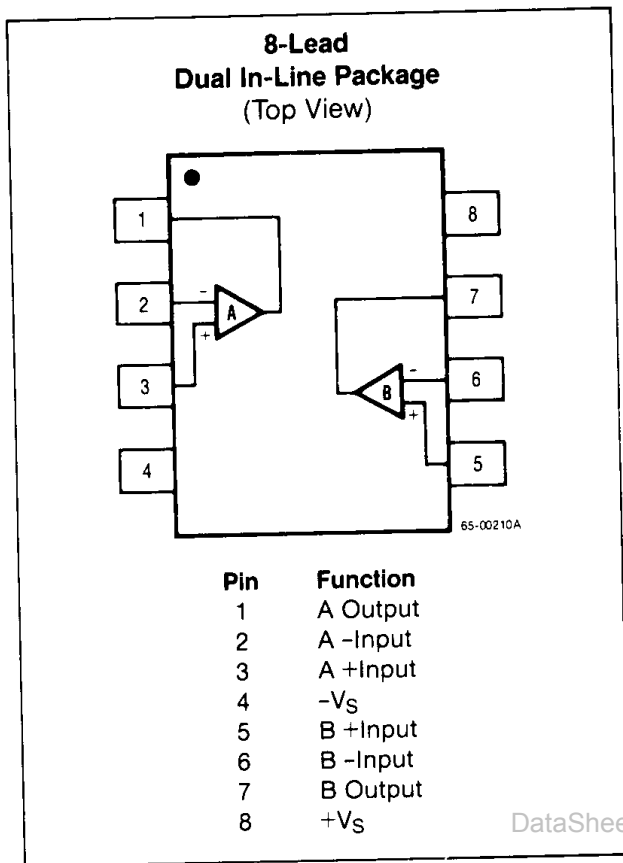

Absolute Maximum Ratings

- Supply Voltage $\pm 18V$
- Input Voltage¹ $\pm 15V$
- Differential Input Voltage 30V
- Output Short Circuit Duration² Indefinite
- Operating Temperature Range $-20^{\circ}C$ to $+75^{\circ}C$
- Lead Soldering Temperature (10 Sec)
 - RC4556NB $+300^{\circ}C$
 - RC4556M $+260^{\circ}C$

- Notes: 1. For supply voltages less than $\pm 15V$, the absolute maximum input voltage is equal to the supply voltage.
 2. Short circuit may be to ground on one amp only. Rating applies to $+75^{\circ}C$ ambient temperature.

Mask Pattern

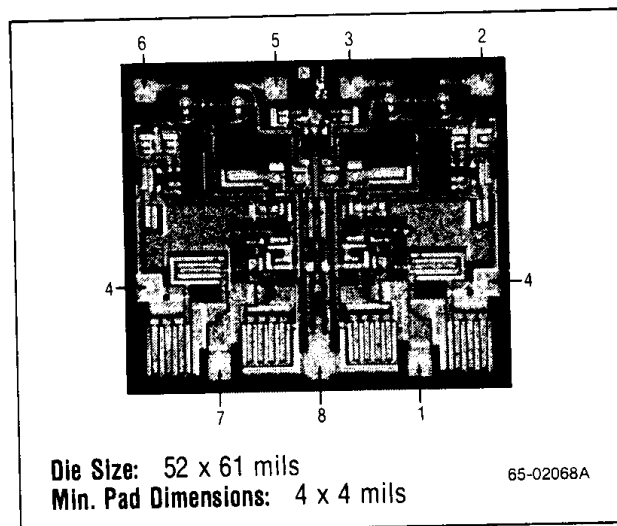

Thermal Characteristics

	8-Lead Micro-Pak Plastic DIP	8-Lead Plastic DIP
Max. Junction Temp.	125°C	125°C
Max. P _D T _A < 50°C	300mW	468mW
Therm. Res. θ_{JC}	—	—
Therm. Res. θ_{JA}	240°C/W	160°C/W
For T _A > 50°C Derate at	4.17mW per °C	6.25mW per °C

Ordering Information

Part Number	Package	Operating Temperature Range
RC4556M	Micro-Plastic	$-20^{\circ}C$ to $+75^{\circ}C$
RC4556NB	Plastic	$-20^{\circ}C$ to $+75^{\circ}C$

Matching Characteristics

(V_S = $\pm 15V$, T_A = $+25^{\circ}C$)

Parameter	Conditions	Typ	Units
Voltage Gain	R _L $\geq 20k\Omega$	± 1.0	dB
Input Bias Current		± 15	nA
Input Offset Current		± 7.5	nA
Input Offset Voltage	R _S $\geq 10k\Omega$	± 0.2	mV

High Output Current Dual Operational Amplifier

RC4556

Electrical Characteristics ($V_S = \pm 15V$ and $T_A = +25^\circ C$ unless otherwise specified)

Parameters	Test Conditions	Min	Typ	Max	Units
Input Offset Voltage	$R_S \leq 10k\Omega$		2.0	6.0	mV
Input Offset Current			5.0	200	nA
Input Bias Current			40	500	nA
Input Resistance		0.3	1.0		$M\Omega$
Large Signal Voltage Gain	$R_L \geq 2k\Omega, V_{OUT} = \pm 10V$	20	100		V/mV
Output Voltage Swing	$R_L \geq 2k\Omega$	± 12	± 13.5		V
	$R_L = 150\Omega$	± 10.5	± 11		V
Input Voltage Range		± 12	± 14		V
Common Mode Rejection Ratio	$R_S \leq 10k\Omega$	70	90		dB
Power Supply Rejection Ratio	$R_S \leq 10k\Omega$	76	90		dB
Power Consumption	$R_L = \infty$		270	360	mW
Transient Response	$V_{IN} = 20mV, R_L = 2k\Omega$		0.03		μS
Overshoot	$C_L \leq 100pF$		40		%
Slew Rate	$R_L \geq 2k\Omega$		3.0		$V/\mu S$
Channel Separation	$f = 10kHz, R_S = 1k\Omega, \text{Gain} = 100$		90		dB
Unity Gain Bandwidth		5.0	8.0		MHz
The following specifications apply for $-20^\circ C \leq T_A \leq +75^\circ C$					
Input Offset Voltage	$R_S \leq 10k\Omega$			7.5	mV
Input Offset Current				300	nA
Input Bias Current				800	nA
Large Signal Voltage Gain	$R_L \geq 2k\Omega, V_{OUT} = \pm 10V$	15			V/mV
Output Voltage Swing	$R_L \geq 2k\Omega$	± 10			V
Power Consumption	$T_A = +75^\circ C$		260	340	mW
	$T_A = -20^\circ C$		290	380	

The information contained in this data sheet has been carefully compiled; however, it shall not by implication or otherwise become part of the terms and conditions of any subsequent sale. Raytheon's liability shall be determined solely by its standard terms and conditions of sale. No representation as to application or use or that the circuits are either licensed or free from patent infringement is intended or implied. Raytheon reserves the right to change the circuitry and other data at any time without notice and assumes no liability for inadvertent errors.

6-210



RC4556 High Output Current Dual Operational Amplifier

Typical Performance Characteristics

Input Bias Current as a Function of Ambient Temperature

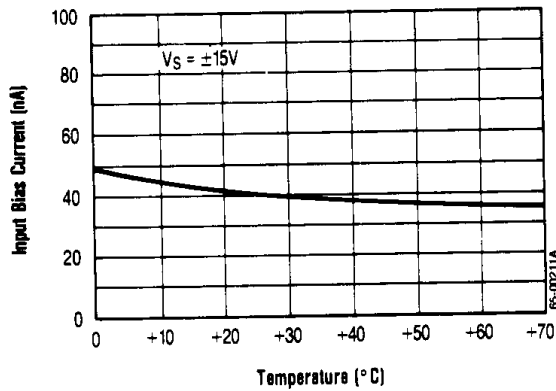

Input Offset Current as a Function of Ambient Temperature

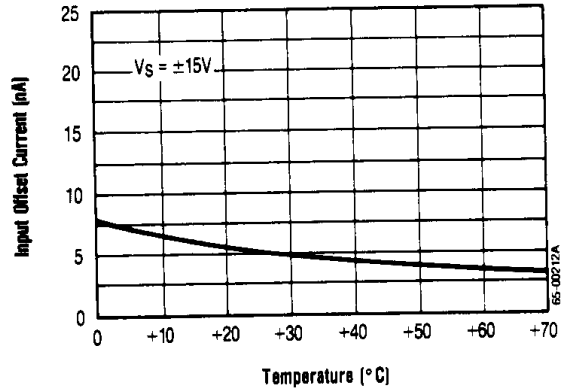

Common Mode Range as a Function of Supply Voltage

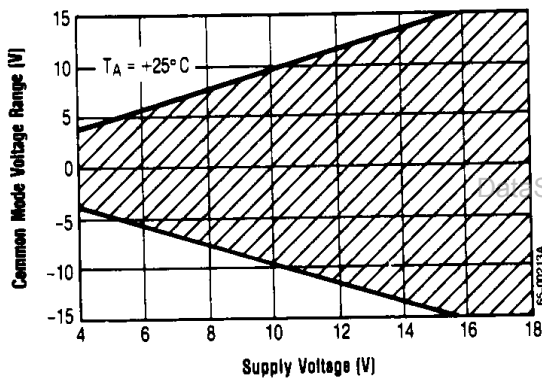

Open Loop Gain as a Function of Temperature

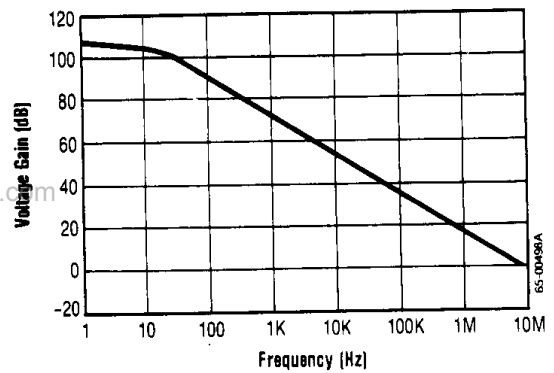

Open Loop Voltage Gain as a Function of Frequency

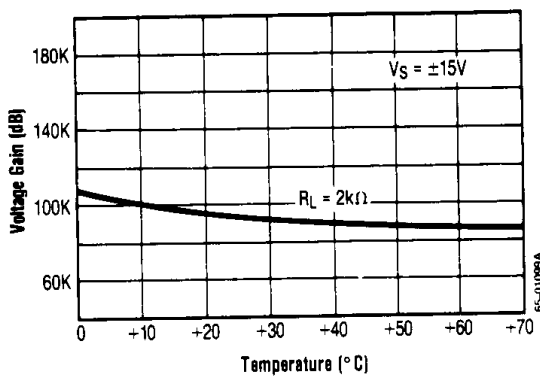

Power Consumption as a Function of Ambient Temperature

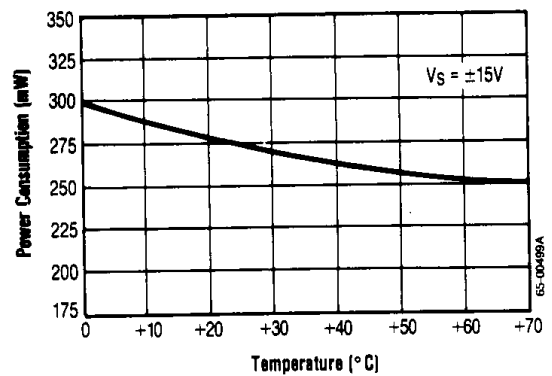

High Output Current Dual Operational Amplifier

RC4556

Typical Performance Characteristics (Continued)

Typical Output Voltage as a Function of Supply Voltage

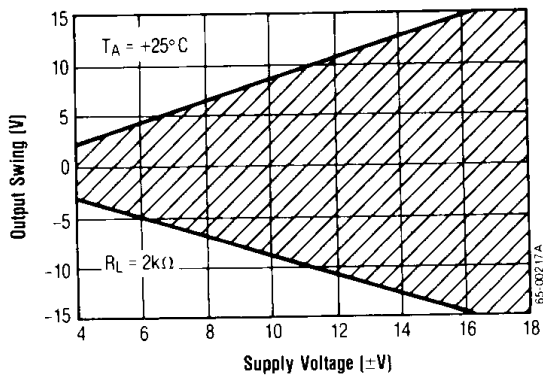

Output Voltage Swing as a Function of Load Resistance

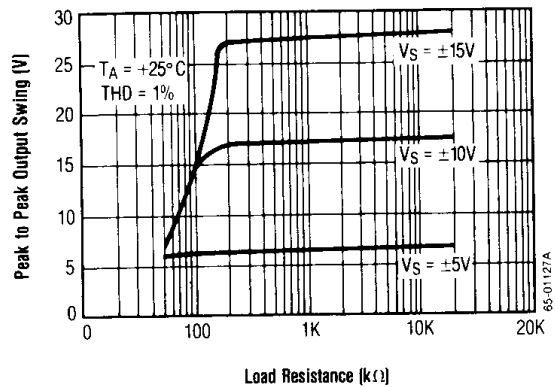

Output Voltage Swing as a Function of Frequency

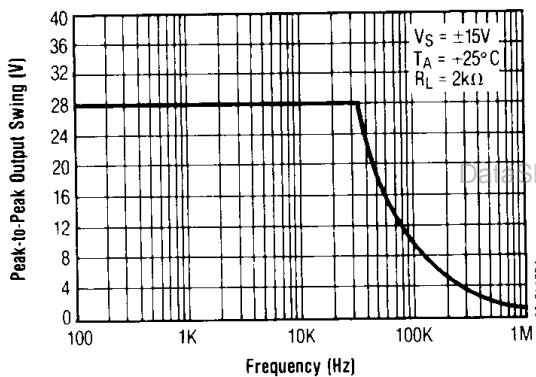

Quiescent Current as a Function of Supply Voltage

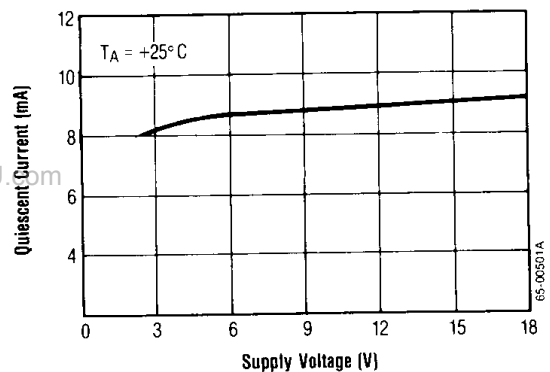

Transient Response

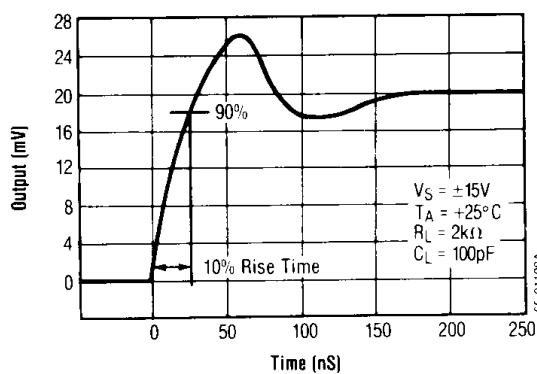

Voltage Follower Large Signal Pulse Response

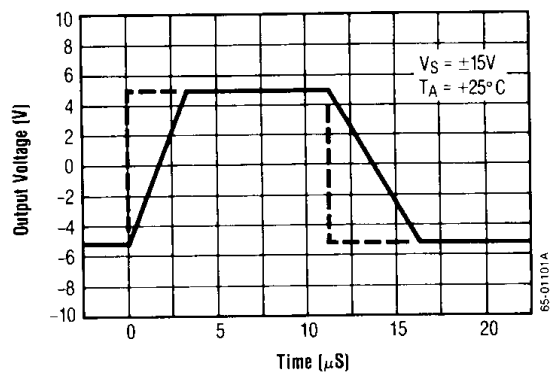

RC4556

High Output Current Dual Operational Amplifier

Typical Performance Characteristics (Continued)

Input Noise Voltage as a Function of Frequency

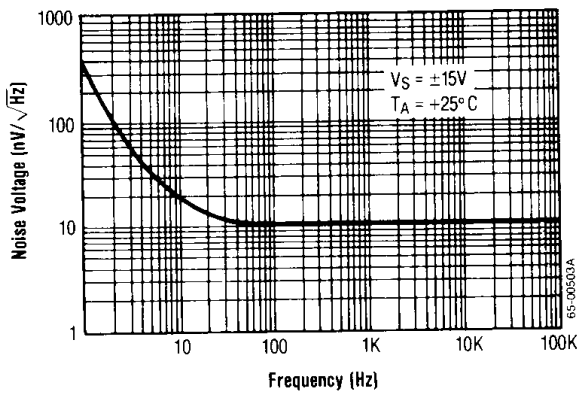

Input Noise Current as a Function of Frequency

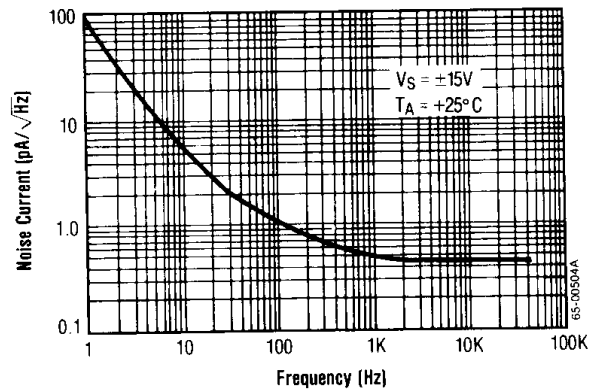

Channel Separation

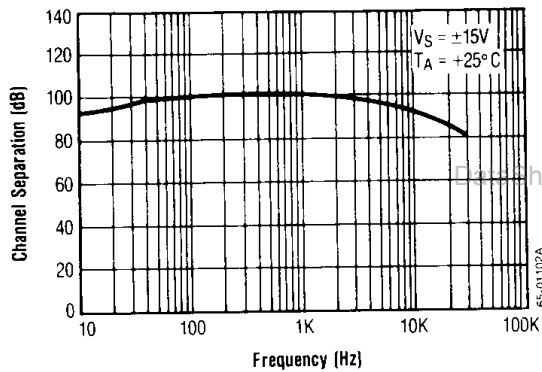

Total Harmonic Distortion vs. Output Voltage

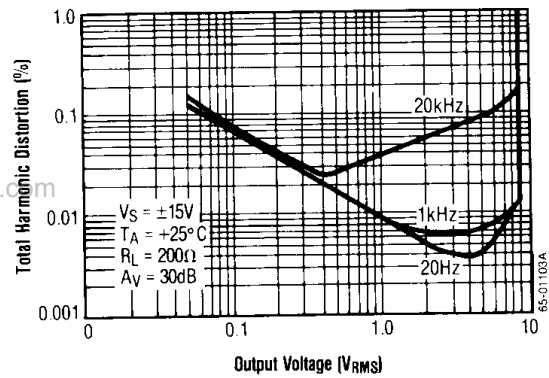

Distortion vs. Frequency

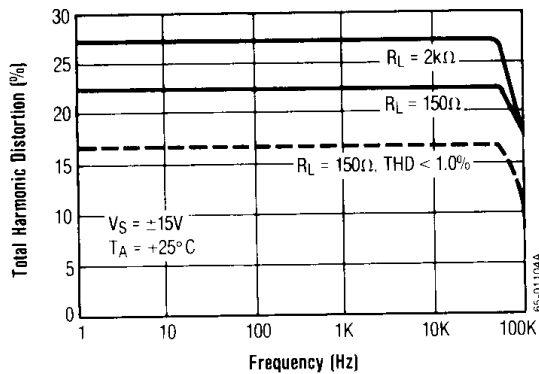

RC4556

High Output Current Dual Operational Amplifier

Comparison of Standard vs. Micro-Package

