

TECHNICAL SPECIFICATION

MODEL NO. : PD064VT2

Customer's Confirmation

Customer _____

Date _____

By _____

PVI's Confirmation

Confirmed By _____

Prepared By _____

PRIME VIEW INTERNATIONAL CO.,LTD.
3,LI SHIN RD. 1,SCIENCE-BASED INDUSTRIAL
PARK,HSINCHU,TAIWAN,R.O.C.
<http://www.pvi.com.tw>

Date : Oct. 17, 2002

This technical specification is subject to change without notice.
Please return 1 copy with your signature on this page for approval.

The information contained herein is the exclusive property of Prime View International Co., Ltd. and shall not be distributed, reproduced, or disclosed in whole or in part without prior written permission of Prime View International Co., Ltd.

*TECHNICAL SPECIFICATION**CONTENTS*

<i>NO.</i>	<i>ITEM</i>	<i>PAGE</i>
-	Cover	1
-	Contents	2
1	Application	3
2	Features	3
3	Mechanical Specifications	3
4	Mechanical Drawing of TFT-LCD module	4
5	Input / Output Terminals	6
6	Absolute Maximum Ratings	7
7	Electrical Characteristics	7
8	Power On Sequence	13
9	Optical Characteristics	14
10	Handling Cautions	17
11	Reliability Test	18
12	Indication of Lot Number Label	18
13	Block Diagram	19
14	Packing Diagram	20
-	Revision History	21

1. Application

This product applies computer peripheral, industrial meter, image communication, web-pad, e-boobs and multi-media.

2. Features

- . Pixel in stripe configuration
- . Slim and compact
- . Display Colors : 262,144 colors
- . Viewing Direction : 6 o'clock
- . Slim module design for mobile electronics device application

3. Mechanical Specifications

Parameter	Specifications	Unit
Screen Size	6.4 (diagonal)	inch
Display Format	640×R, G, B×480	dot
Active Area	129.6(H)×97.44 (V)	mm
Dot Pitch	0.0675 (H)×0.203 (V)	mm
Pixel Pitch	0.203 (H)×0.203 (V)	mm
Pixel Configuration	Stripe	
Outline Dimension	See Mechanical Drawing	mm
Weight	165±10	g

4. Mechanical Drawing of TFT-LCD Module

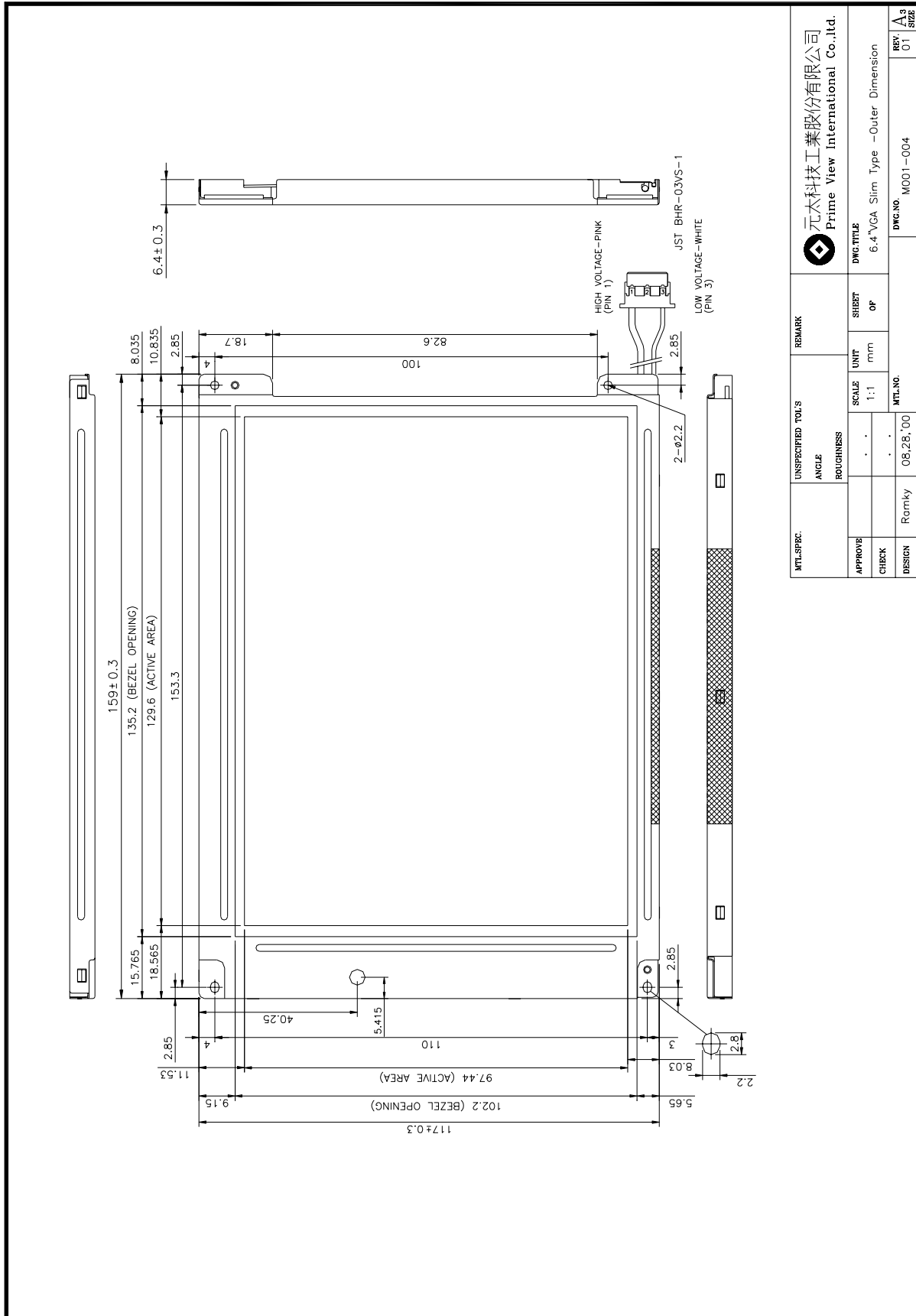

5. Input / Output Terminals

5-1) TFT-LCD Panel Driving

Connector (1) type : ELCO , 6210-30PIN

Pin No.	Symbol	Function	Remark
1	CLK	Clock Signal for Sampling Image Digital Data	
2	Hsync	Horizontal Synchronous Signal	
3	Vsync	Vertical Synchronous Signal	
4	GND	Ground (0V)	
5	R0	Red Image Data Signal (LSB)	
6	R1	Red Image Data Signal	
7	R2	Red Image Data Signal	
8	R3	Red Image Data Signal	
9	R4	Red Image Data Signal	
10	R5	Red Image Data Signal (MSB)	
11	GND	Ground (0V)	
12	G0	Green Image Data Signal (LSB)	
13	G1	Green Image Data Signal	
14	G2	Green Image Data Signal	
15	G3	Green Image Data Signal	
16	G4	Green Image Data Signal	
17	G5	Green Image Data Signal (MSB)	
18	GND	Ground (0V)	
19	B0	Blue Image Data Signal (LSB)	
20	B1	Blue Image Data Signal	
21	B2	Blue Image Data Signal	
22	B3	Blue Image Data Signal	
23	B4	Blue Image Data Signal	
24	B5	Blue Image Data Signal (MSB)	
25	GND	Ground (0V)	
26	NC	No connection	
27	VCC	DC +3.3V Power Supply	
28	VCC	DC +3.3V Power Supply	
29	NC	No connection	
30	NC	No connection	

5-2) Backlight driving

Pin No	Symbol	Description	Remark
1	VL1	Input terminal (Hi voltage side)	Wire color : Pink
2	NC	No Connection	
3	VL2	Input terminal (Low voltage side)	Wire Color : White Note 5-1

Note 5-1 : Low voltage side of backlight inverter connects with ground of inverter circuits.

5-3) Input / Output Connector

- A) LCD module connector
ELCO , 6210-30PIN
Down Connector
Pin No. : 30
Pitch : 0.5 mm

- B) Backlight Connector
JST BHR-03VS-1
Pin No. : 3
Pitch : 4 mm
Red : High Voltage
White : Low Voltage

6. Absolute Maximum Ratings :

GND=0V, Ta=25°C

Parameters	Symbol	MIN.	MAX.	Unit	Remark
+3.3V Supply Voltage	V _{CC}	-0.3	+4.0	V	
Input Signals Voltage	V _{sig}	-0.3	V _{CC} +0.3	V	Note 6-1
Storage Temperature	T _{stg}	-20	+70	°C	Note 6-2
Operating Temperature	T _{opa}	-0	+60	°C	

Note 6-1 : Input signals include CLK, Hsync, Vsync, R[0:5], G[0:5] and B[0:5].

Note 6-2 : Humidity : 95% RH Max. at Ta ≤ 40°C.

Maximum wet-bulb temperature is at 39 °C or less at Ta > 40 °C.

No condensation.

7. Electrical Characteristics

7-1) Recommended Operating Conditions :

A) Driving for TFT-LCD panel

GND = 0V , Ta = 25 °C

Parameters		Symbol	Min.	Typ.	Max.	Unit	Remark
+3.3V	Supply Voltage	V _{CC}	+3.15	+3.3	+3.6	V	
	Supply Input Ripple Voltage	V _{CCRP}			0.1	Vp-p	V _{CC} =+3.3V
	Input Signals Voltage (High)	V _{IH}	+3.0	+3.3	+3.6	V	
	Input Signals Voltage (Low)	V _{IL}	-	0	+0.3	V	

B) Driving for backlight

Ta = 25 °C

Item	Symbol	Min.	Typ.	Max.	Unit	Remark
Lamp Current	I _L	3	5	7	mA	
Lamp Voltage	V _L	350	390	420	Vrms	
Oscillation	P _L	45	64	80	KHz	
Lamp Life Time		-	20,000	-	Hr	
Kick-off voltage(25°C)	V _s	-	845	1,050	Vrms	
Kick-off voltage(0°C)	V _s	-	1,045	1,250	Vrms	

7-2) Power Consumption

Parameters	Symbol	Typ.	Max.	Unit	Remark
+3.3V Current Dissipation	I _{CC}	170	200	mA	
Input Signals Current (High)	I _{IH}		100	μA	V _{IH} = +3.3V
Input Signals Current (Low)	I _{IL}		100	μA	V _{IL} = 0V
LCD Panel Power Consumption		0.56	0.66	W	Note 7-1
Backlight Power Consumption		1.95	2.10	W	Note 7-2

Note 7-1 : The power consumption of backlight is not included.

Note 7-2 : Backlight lamp power consumption is calculated by $I_L \times V_L$.

7-3) Input / Output signal timing chart

Parameters	Symbol	Min.	Typ.	Max.	Unit	Note	
Frequency	Fc=1/Tc		25.175		MHz	Note 7-3	
Clock	High Time	Tckh	10		ns		
	Low Time	Tckl	10		ns		
	Periodic = Line	Thp	31.778		μs	Note 7-3	
Hsync			800	1024	clock	Note 7-3	
	Pulse Width	Thpw	2	96	200	clock	
	Back Porch	Thbp	2	49	64	clock	
			515	525	1024	line	Note 7-3
Vsync	Pulse Width	Tvpw	1	2		line	
	Back Porch	Tvbp	1	33	64	line	
Data	Setup Time	Tds	10			ns	
	Hold Time	Tdh	10			ns	
	Periodic = Line	Tep	800	1024	clock		
	Pulse Width (H)	Tepw	2	640	800	clock	
Horizontal Display Periodic		Thd	640	640	640	clock	
Hsync-CLK Phase Difference		Thc	10		Tc-10	ns	
Vsync-Hsync Phase Difference		Tvh	1		Thp-1	clock	

Note 7-3 : Tc is the period of sampling clock. In case of low-frequency, the image-flicker may occur.

7-4) Display Time Range

(1) Vertical Timing :

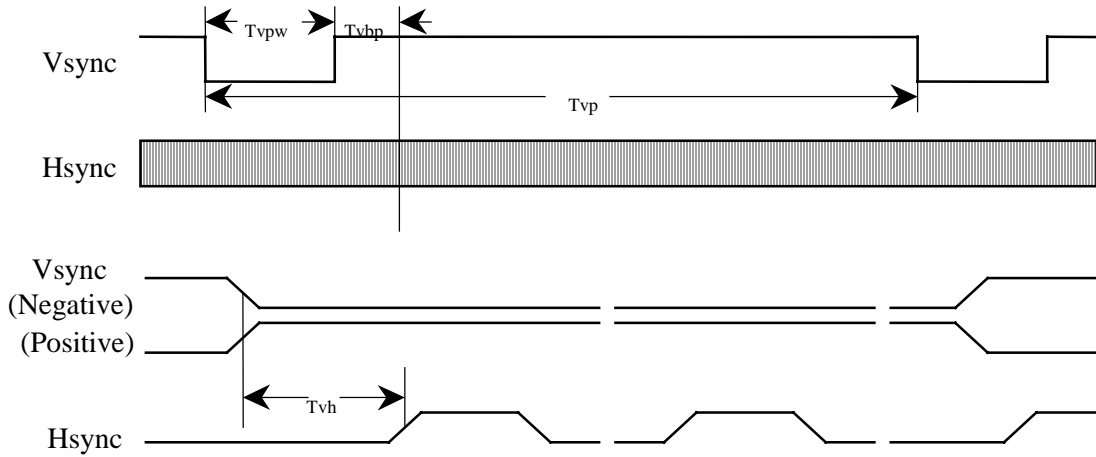

(2) Horizontal Timing :

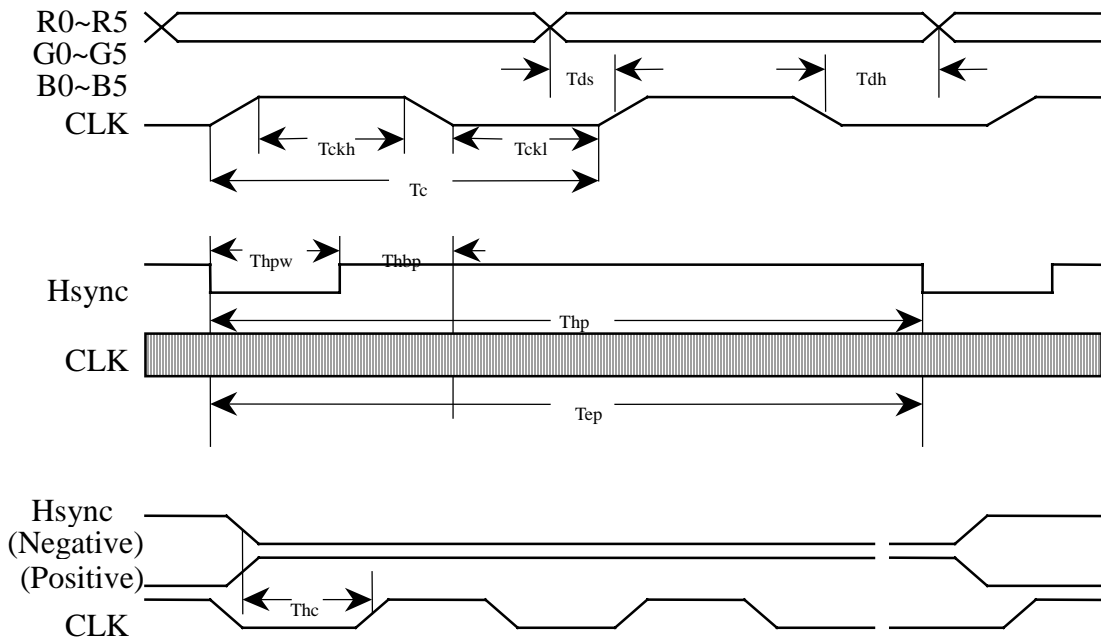

(3). Detail of Horizontal Timing :

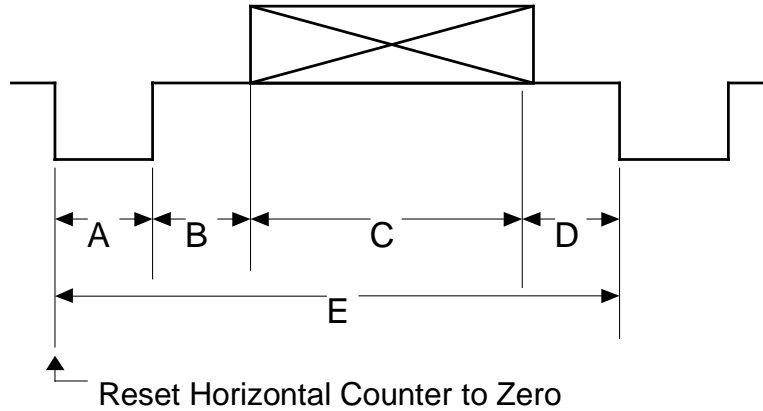

Item	Description	Clock Cycles	Time
A	Horizontal Width	96	3.813 μs
B	Horizontal B-Porch	49	1.907 μs
C	Horizontal Display	640	25.422 μs
D	Horizontal F-Porch	16	0.636 μs
E	Horizontal Total	800	31.778 μs

(4). Detail of Vertical Timing :

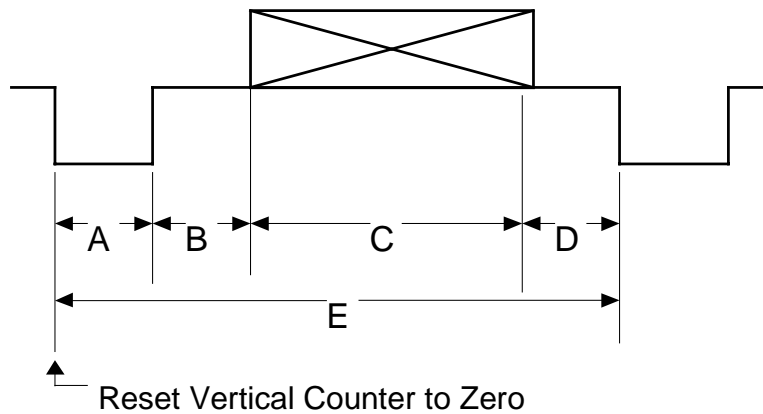

Item	Description	Horizontal Lines	Time
A	Vertical Width	2	63.5 μs
B	Vertical B-Porch	33	1.049 ms
C	Vertical Display	480	15.253 ms
D	Vertical F-Porch	10	317.8 μs
E	Vertical Total	525	16.683 ms

7-5) Pixel Arrangement

The LCD module pixel arrangement is the stripe.

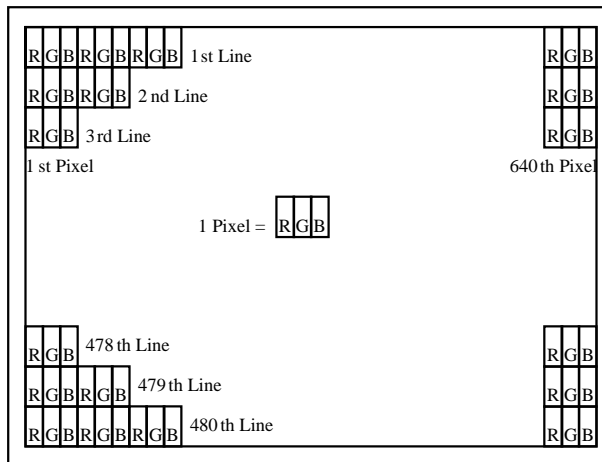

7-6) Display Color and Gray Scale Reference

Color		Input Color Data																	
		Red						Green						Blue					
		R5	R4	R3	R2	R1	R0	G5	G4	G3	G2	G1	G0	B5	B4	B3	B2	B1	B0
Basic Colors	Black	0	0	0	0	0	0	0	0	0	0	0	0	0	0	0	0	0	0
	Red (63)	1	1	1	1	1	1	0	0	0	0	0	0	0	0	0	0	0	0
	Green (63)	0	0	0	0	0	0	1	1	1	1	1	1	0	0	0	0	0	0
	Blue (63)	0	0	0	0	0	0	0	0	0	0	0	0	1	1	1	1	1	1
	Cyan	0	0	0	0	0	0	1	1	1	1	1	1	1	1	1	1	1	1
	Magenta	1	1	1	1	1	1	0	0	0	0	0	0	1	1	1	1	1	1
	Yellow	1	1	1	1	1	1	1	1	1	1	1	1	0	0	0	0	0	0
	White	1	1	1	1	1	1	1	1	1	1	1	1	1	1	1	1	1	1
Red	Red (00)	0	0	0	0	0	0	0	0	0	0	0	0	0	0	0	0	0	0
	Red (01)	0	0	0	0	0	1	0	0	0	0	0	0	0	0	0	0	0	0
	Red (02)	0	0	0	0	1	0	0	0	0	0	0	0	0	0	0	0	0	0
	Darker																		
	↓	↓	↓	↓	↓	↓	↓	↓	↓	↓	↓	↓	↓	↓	↓	↓	↓	↓	↓
	Brighter																		
	Red (61)	1	1	1	1	0	1	0	0	0	0	0	0	0	0	0	0	0	0
	Red (62)	1	1	1	1	1	0	0	0	0	0	0	0	0	0	0	0	0	0
Red (63)	1	1	1	1	1	1	0	0	0	0	0	0	0	0	0	0	0	0	
Green	Green (00)	0	0	0	0	0	0	0	0	0	0	0	0	0	0	0	0	0	0
	Green (01)	0	0	0	0	0	0	0	0	0	0	0	1	0	0	0	0	0	0
	Green (02)	0	0	0	0	0	0	0	0	0	0	1	0	0	0	0	0	0	0
	Darker																		
	↓	↓	↓	↓	↓	↓	↓	↓	↓	↓	↓	↓	↓	↓	↓	↓	↓	↓	↓
	Brighter																		
	Green (61)	0	0	0	0	0	0	1	1	1	1	0	1	0	0	0	0	0	0
	Green (62)	0	0	0	0	0	0	1	1	1	1	1	0	0	0	0	0	0	0
Green (63)	0	0	0	0	0	0	1	1	1	1	1	1	0	0	0	0	0	0	
Blue	Blue (00)	0	0	0	0	0	0	0	0	0	0	0	0	0	0	0	0	0	0
	Blue (01)	0	0	0	0	0	0	0	0	0	0	0	0	0	0	0	0	0	1
	Blue (02)	0	0	0	0	0	0	0	0	0	0	0	0	0	0	0	0	1	0
	Darker																		
	↓	↓	↓	↓	↓	↓	↓	↓	↓	↓	↓	↓	↓	↓	↓	↓	↓	↓	↓
	Brighter																		
	Blue (61)	0	0	0	0	0	0	0	0	0	0	0	0	1	1	1	1	0	1
	Blue (62)	0	0	0	0	0	0	0	0	0	0	0	0	1	1	1	1	1	0
Blue (63)	0	0	0	0	0	0	0	0	0	0	0	0	1	1	1	1	1	1	

8. Power On Sequence

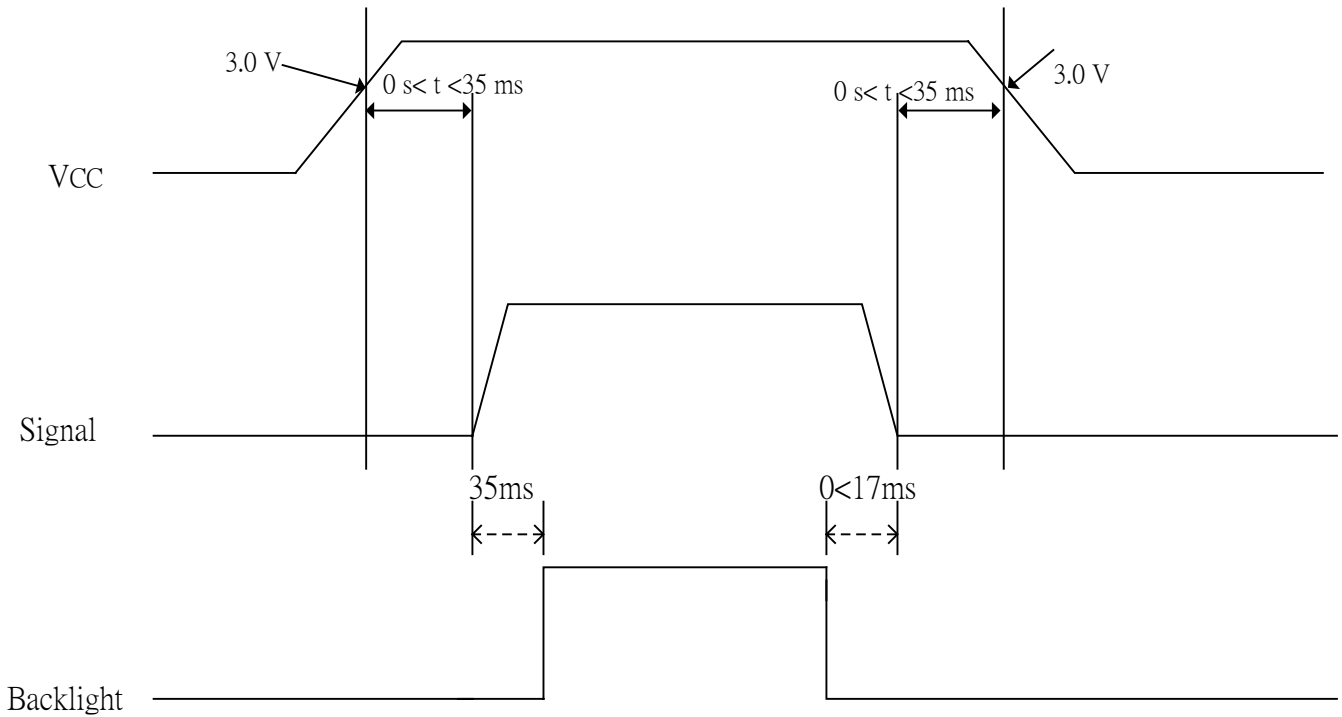

1. The supply voltage for input signals should be same as V_{CC} .
2. When the power is off , please keep whole signals (Hsync, Vsync, CLK, Data) low level or high impedance

9. Optical Characteristics

9-1) Specification :

Ta=25°C

Parameter	Symbol	Condition	MIN.	TYP.	MAX.	Unit	Remarks
Viewing Angle	Horizontal	θ	± 35	± 45		deg	Note 9-3
	Vertical	θ (to 12 o'clock)	10	15	-	deg	
		θ (to 6 o'clock)	30	35	-	deg	
Contrast Ratio	CR		150	180	-	-	Note 9-1
Response time	Rise	Tr	-	15	30	ms	Note 9-4
	Fall	Tf	-	25	50	ms	
Brightness		$\theta=0^\circ/\varphi=0$	120	150		cd/m ²	Note 9-2
Luminance Uniformity	U		55	80	-	%	Note 9-6
Lamp Life Time			-	20,000	-	hr	
White Chromaticity	x		0.230	0.280	0.330	-	
	y		0.270	0.320	0.370	-	
Cross Talk		$\theta=0^\circ$	-	-	3	%	Note 9-5

All the optical measurement shall be executed 30 minutes after backlight being turn-on. The optical characteristics shall be measured in dark room (ambient illumination on panel surface less than 1 Lux). The measuring configuration shows as following figure.

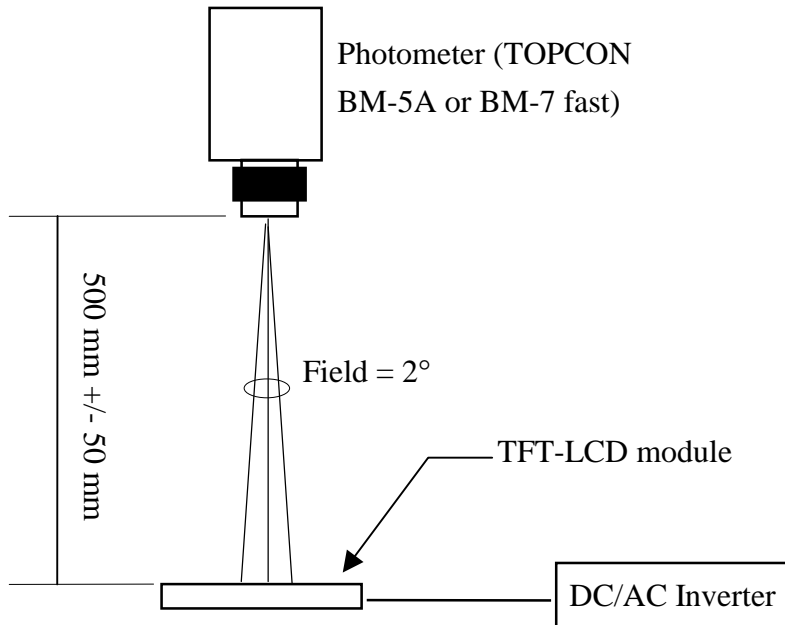

Optical characteristics measuring configuration

Note 9-1 : CR = $\frac{\text{Luminance when LCD is White}}{\text{Luminance when LCD is Black}}$

Contrast Ratio is measured in optimum common electrode voltage.

Note 9-2 : Topcon BM-7(fast) luminance meter 2° field of view is used in the testing (after 20~30 minutes' operation).

Note 9-3 : The definitions of viewing angle diagrams :

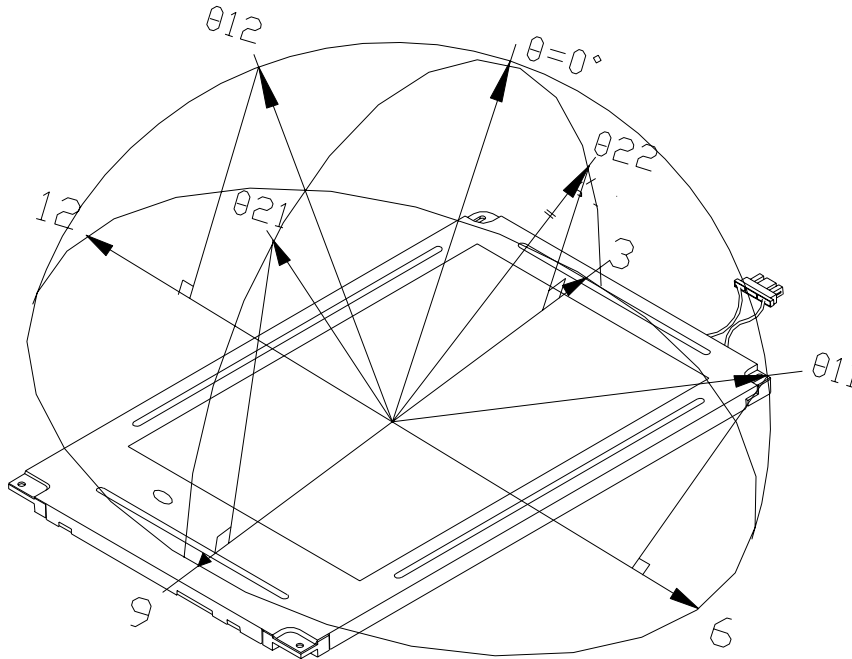

Note 9-4 : Definition of Response Time Tr and Tr:

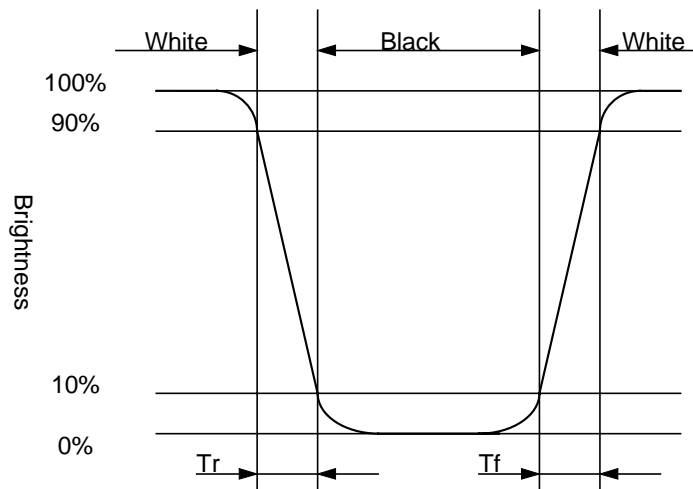

Note 9-5 : Cross Talk (CTK) = $\frac{|YA-YB|}{YA} \times 100\%$

YA : Brightness of Pattern A

YB : Brightness of Pattern B

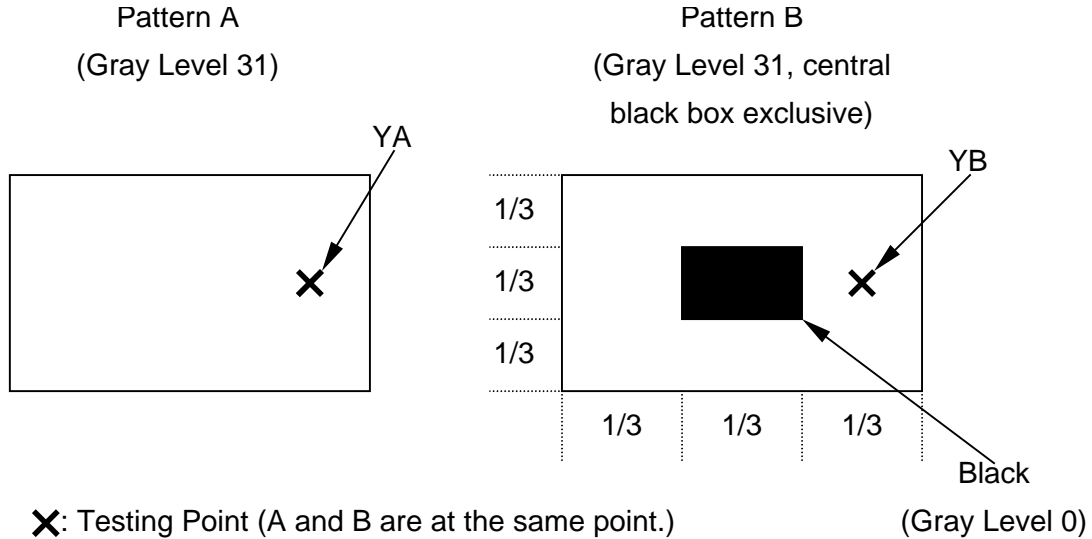

Note 9-6 : The uniformity of LCD is defined as

$$U = \frac{\text{The Minimum Brightness of the 9 testing Points}}{\text{The Maximum Brightness of the 9 testing Points}}$$

Luminance meter : BM-5A or BM-7 fast(TOPCON)

Measurement distance : 500 mm +/- 50 mm

Ambient illumination : < 1 Lux

Measuring direction : Perpendicular to the surface of module

The test pattern is white (Gray Level 63).

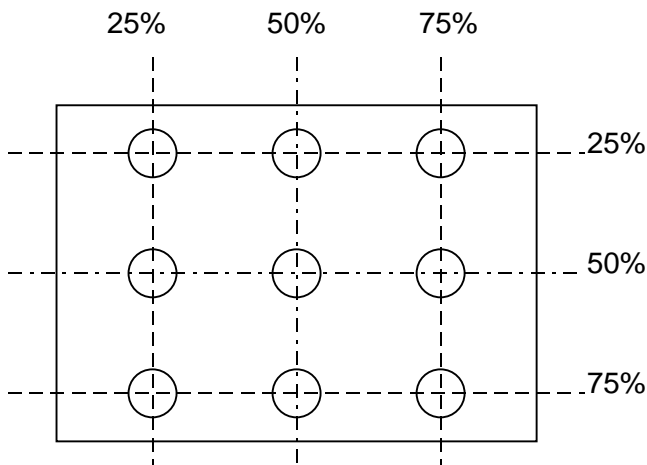

10. Handling Cautions

10-1) Mounting of module

- a) Please power off the module when you connect the input/output connector.
- b) Please connect the ground pattern of the inverter circuit surely. If the connection is not perfect, some following problems may happen possibly.
 - 1.The noise from the backlight unit will increase.
 - 2.The output from inverter circuit will be unstable.
 - 3.In some cases a part of module will heat.
- c) Polarizer which is made of soft material and susceptible to flaw must be handled carefully.
- d) Protective film (Laminator) is applied on surface to protect it against scratches and dirt. It is recommended to peel off the laminator before use and taking care of static electricity.

10-2) Precautions in mounting

- a) When metal part of the TFT-LCD module (shielding lid and rear case) is soiled, wipe it with soft dry cloth.
- b) Wipe off water drops or finger grease immediately. Long contact with water may cause discoloration or spots.
- c) TFT-LCD module uses glass which breaks or cracks easily if dropped or bumped on hard surface. Please handle with care.
- d) Since CMOS LSI is used in the module. So take care of static electricity and earth yourself when handling.

10-3) Adjusting module

- a) Adjusting volumes on the rear face of the module have been set optimally before shipment.
- b) Therefore, do not change any adjusted values. If adjusted values are changed, the specifications described may not be satisfied.

10-4) Others

- a) Do not expose the module to direct sunlight or intensive ultraviolet rays for many hours.
- b) Store the module at a room temperature place.
- c) The voltage of beginning electric discharge may over the normal voltage because of leakage current from approach conductor by to draw lump read lead line around.
- d) If LCD panel breaks, it is possibly that the liquid crystal escapes from the panel. Avoid putting it into eyes or mouth. When liquid crystal sticks on hands, clothes or feet. Wash it out immediately with soap.
- e) Observe all other precautionary requirements in handling general electronic components.
- f) Please adjust the voltage of common electrode as material of attachment by 1 module.
- g) The UL number for PCB is EE2956.

11. Reliability Test

No	Test Item	Test Condition
1	High Temperature Storage Test	Ta = +70 °C , 240 hrs
2	Low Temperature Storage Test	Ta = -20 °C , 240 hrs
3	High Temperature Operation Test	Ta = +60 °C , 240 hrs
4	Low Temperature Operation Test	Ta = 0 °C , 240 hrs
5	High Temperature & High Humidity Operation Test	Ta = +40 °C , 95%RH, 240 hrs
6	Thermal Cycling Test (non-operating))	-25°C → +25°C → +70°C , 200 Cycles 30 min 5min 30min
7	Vibration Test (non-operating)	Frequency : 10 ~ 57 Hz/Vibration Width :0.075mm 58-500 Hz/ Gravity :9.8m/s ² Sweep time: 11 minutes Test period: 3 hrs for each direction of X, Y, Z
8	Shock Test (non-operating)	Gravity :490m/s ² Direction: ±X, ±Y, ±Z Pulse Width :11ms,half sine wave
9	Electrostatic Discharge Test (non-operating)	150pF , 330Ω Air : ±15KV ; Contact : ±8KV 10 times/point , 9 point/panel face

Ta: ambient temperature

[Judgement Criteria]

Under the display quality test conditions with normal operation state , there should be no change which may affect practical display function.

12. Indication of Lot Number Label

a) Indicated contents of the label

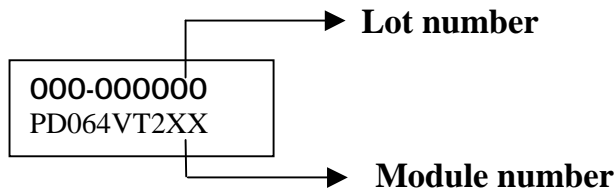

Contents of lot number : 1st—Process area : class 1000 ⇒ H

class 100K ⇒ M

2nd~3rd—Module screen size(in inch) : 1.8”⇒18, 2.5”⇒25.....

5th—Production year : 1999⇒9, 2000⇒A, 2001⇒1.....

6th—Production month : 1, 2, 3,...9, A, B, C

7th~10th—Serial numbers : 0001~9999

13. Block Diagram

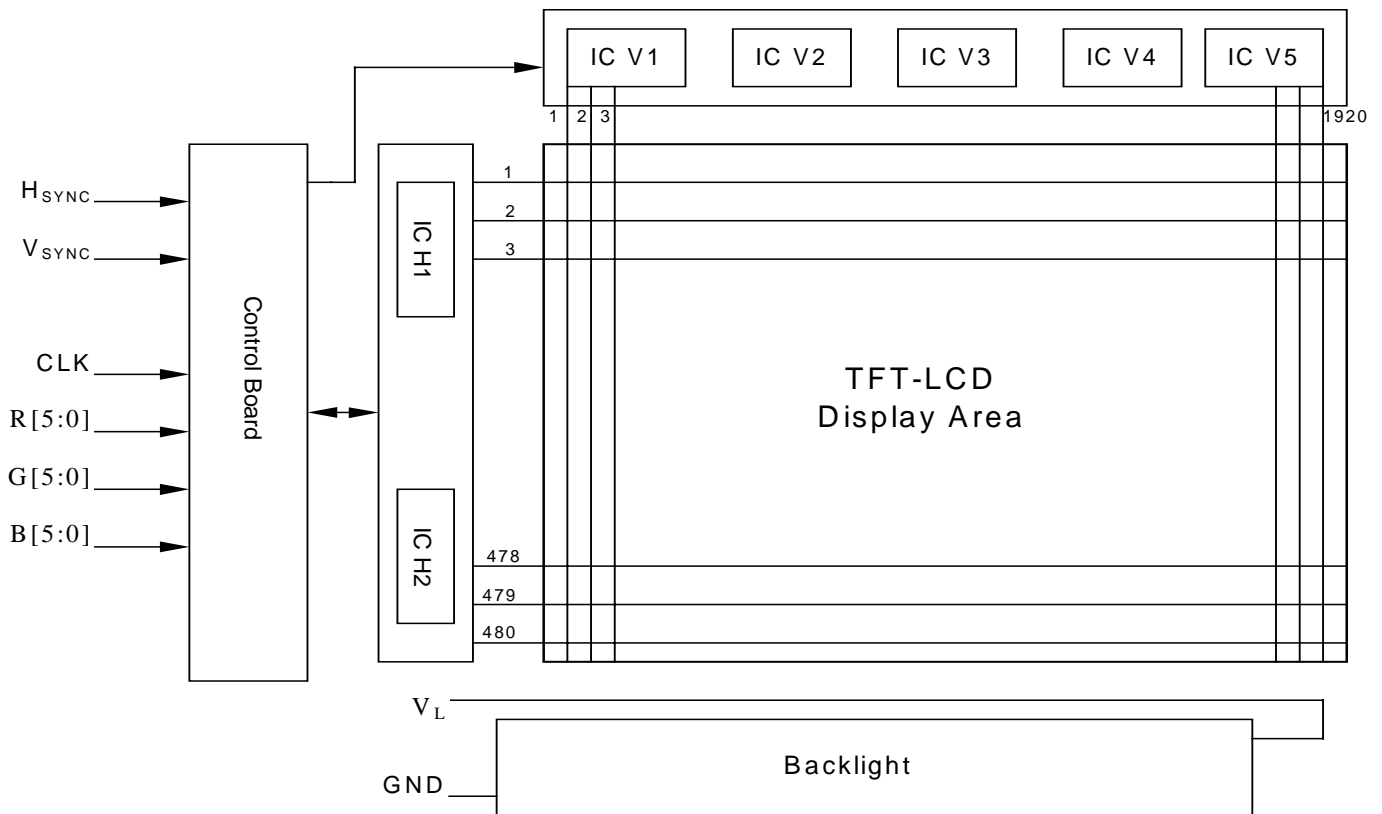

14. Packing

ZONE	REV.	DOCUMENT NO.	DESCRIPTION	DATE	REV. BY																														
<p>NOTE: 1. Q'TY: 30 pcs panel/carton. 2. Dimension: 680*440*250mm 3. Weight: TBD</p>																																			
		<table border="1" style="width:100%; border-collapse: collapse;"> <tr> <td style="width:5%;">5</td> <td style="width:20%;">50-0100131</td> <td style="width:55%;">CARTON</td> <td style="width:10%;">1</td> <td style="width:10%;"></td> </tr> <tr> <td>4</td> <td>50-0300201</td> <td>PP緩衝材 底座</td> <td>1</td> <td></td> </tr> <tr> <td>3</td> <td>50-0500051</td> <td>Pink Bag 150*250mm</td> <td>30</td> <td>抗靜電</td> </tr> <tr> <td>2</td> <td>PD064VT2T1</td> <td></td> <td>30</td> <td></td> </tr> <tr> <td>1</td> <td>50-0300191</td> <td>PP緩衝材 上蓋</td> <td>1</td> <td></td> </tr> <tr> <td>ITEM</td> <td>PART NO.</td> <td>DESCRIPTION</td> <td>QTY</td> <td>REMARK</td> </tr> </table>		5	50-0100131	CARTON	1		4	50-0300201	PP緩衝材 底座	1		3	50-0500051	Pink Bag 150*250mm	30	抗靜電	2	PD064VT2T1		30		1	50-0300191	PP緩衝材 上蓋	1		ITEM	PART NO.	DESCRIPTION	QTY	REMARK		
5	50-0100131	CARTON	1																																
4	50-0300201	PP緩衝材 底座	1																																
3	50-0500051	Pink Bag 150*250mm	30	抗靜電																															
2	PD064VT2T1		30																																
1	50-0300191	PP緩衝材 上蓋	1																																
ITEM	PART NO.	DESCRIPTION	QTY	REMARK																															
MTL.SPEC.		UNSPECIFIED TOL'S		REMARK																															
		ANGLE																																	
		ROUGHNESS																																	
APPROVE		SCALE	UNIT	SHEET	DWG.TITLE																														
CHECK				1 OF 1	PD064VT2T1 Packing Draw																														
DRAWN	陳萬典	00.08.30	MTL.NO. PD064VT2T1		DWG FILE: REV. 01																														
					A4 SIZE																														

Revision History

Rev.	Issued Date	Revised Contents
Preliminary (0.1)	Aug. 29, 2000	NEW
Preliminary (0.2)	Sept,21, 2000	Revise
Preliminary (0.3)	Jan.,17, 2001	Modify 1. Input signals and voltage=3.3V (typ.) 2. Page7 : Thbp=49 clock, Tvbp=33 line
Preliminary (0.4)	Feb.,20, 2001	Modify 1. Page6 : Oscillation=64KHZ ADD 1. Page6 : Kick-off voltage
Preliminary (0.5)	June, 04, 2001	Modify 1. 5-1) input pin define pin26 modify from "DENB" to "NC" 2. 7-1) Recommended operation condition Min. Input voltage modify from 3.0V to 3.15V 3. Erase original (7-6) Horizontal Display position, this section describes the "DENB" definition, which is useless in this module.
Preliminary (0.6)	July 20, 2001	Modify 1. Page4: 4.Mechanical Drawing of TFT-LCD Module 2. Page5: Connector(1) type : ELCO , 6210-30PIN
1.0	Aug 09,2001	Add Page12: Power On Sequence
1.1	Aug 15,2001	Modify 1. Page4:4.Mechanical Drawing of TFT-LCD Module 2. Page6:+3.3V Max. Supply Voltage from 7.0V to 4.0V.
1.2	Oct 17,2001	Add 1. Page14: Luminance Uniformity 2. Page14: Brightness measurement method 3. Page15: Note 9-4: Definition of Response Time Tr and Tf
1.3	Dec 11,2001	Add Page17: Handling Cautions Page18: Indication of Lot Number Label
1.4	Apr. 10, 2002	Modify Page 7 : Driving for backlight Page 8 : Power Consumption
1.5	Apr. 12, 2002	Modify Page 14 : Optical Characteristics (Brightness)
1.6	Oct. 17, 2002	Modify Page 17 : Handling Cautions (The UL number)