

SPECIFICATIONS

Electrical Ratings	3A @ 120VAC, 28VDC; 1A @ 250VAC See Contact Options
Electrical Life	30,000 cycles typical
Contact Resistance	< 20 mΩ max initial @ 2-4VDC, 100mA
Dielectric Strength	1500Vrms min
Insulation Resistance	> 100MΩ min
Operating Temperature	-40°C to 85°C
Storage Temperature	-40°C to 85°C



UL US - E222871







MATERIALS ←RoHS COMPLIANT



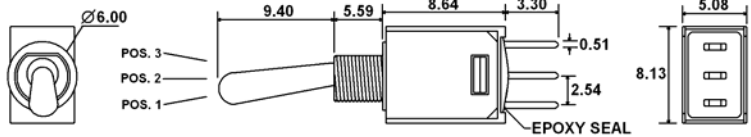

Actuator	Brass, Chrome Plated
Housing	DAP – Diallyl Phthalate
Cover	Stainless Steel
Bushing	Brass, Nickel Plated
Contacts	Copper Alloy, Silver or Gold Plated
Terminals	Brass, Silver or Gold Plated

ORDERING INFORMATION

Series:	BNT	2	1	U	E1	C	Q	E
BNT								
Number of Poles:								
1 = SPDT								
2 = DPDT								
Switch Function:								
1 = ON-NONE-ON								
2 = ON-NONE-(ON)								
3 = ON-OFF-ON								
4 = (ON)-OFF-(ON) ** Only available in SPDT								
5 = ON-OFF-(ON) ** Only available in SPDT								
6 = ON-ON-ON ** See Three Way Wiring Section for Details								
Actuator:								
T = 5.33mm, Std, available on E/E1/F/F1 Bushings								
U = 7.37mm, Std, available on E/E1/F/F1 Bushings								
S = 9.40mm, Std, available on E/E1/F/F1 Bushings								
X = 5.59mm, Std, available on G/G1/J/J1 Bushings								
V = 10.41mm, Std, available on G/G1/J/J1 Bushings								
Bushing:								
E / E1 = 5.59mm, 10-48UNS / Non-Threaded, Flat								
F / F1 = 5.59mm, 10-48UNS / Non-Threaded, Keyway								
J / J1 = 6.60mm, ¼-40NS / Non-Threaded, Keyway								
G / G1 = 7.87mm, ¼-40NS / Non-Threaded, Flat								
Terminals:								
B = Solder Lug								
C = PC Pin								
H = Horizontal Mount, Right Angle PC Pin; HS = Snap-in								
V = Vertical Mount, Right Angle PC Pin; VS = Snap-in								
A5 = PC Pin with Support Bracket; A5S = Snap-in Support Bracket								
Contacts:								
Q = Silver Plated								
R = Gold Plated								
G = Gold over Silver Plated								
Epoxy Seal:								
E = Epoxy Seal								

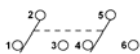
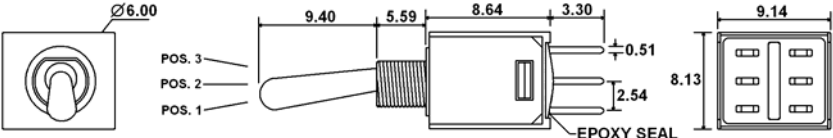
SWITCH FUNCTION

 SPDT 	Function	Toggle Position			
					
	1	ON	NONE	ON	
	2	ON	NONE	(ON)	
	3	ON	OFF	ON	
4	(ON)	OFF	(ON)		
5	ON	OFF	(ON)		
Terminals	2-3	---	2-1		

 DPDT 	Function	Toggle Position			
					
	1	ON	NONE	ON	
	2	ON	NONE	(ON)	
	3	ON	OFF	ON	
Terminals	2-3 5-6	---	2-1 5-4		
6	ON	ON	ON		
Terminals	2-3 5-6	2-3 5-4	2-1 5-4		

ACTUATOR OPTIONS

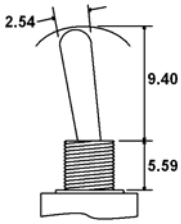
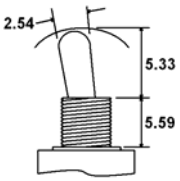
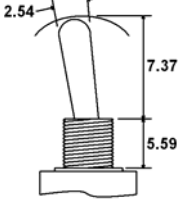
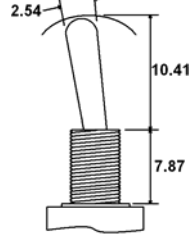
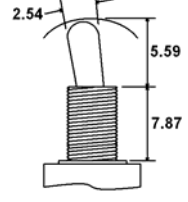
 S	 T	 U	 V	 X
---	---	---	--	---

**Only available with E, E1, F, & F1 Bushings

**Only available with G, G1, J, & J1 Bushings

BUSHING OPTIONS

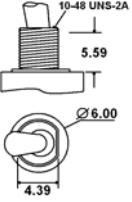
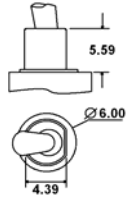
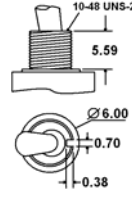
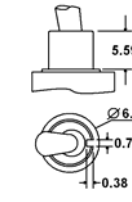
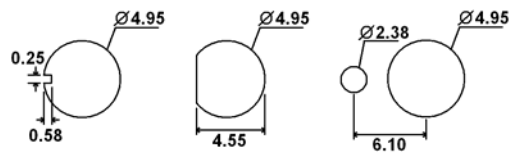
 E	 E1	 F	 F1	
				Panel Mounting – 10-48

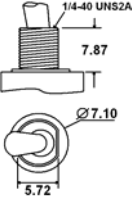
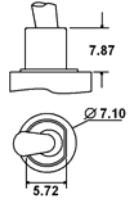
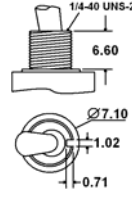
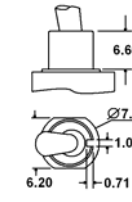
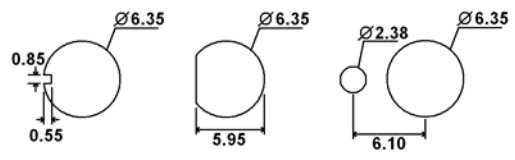
 G	 G1	 J	 J1	
				Panel Mounting – 1/4-40

TERMINAL OPTIONS

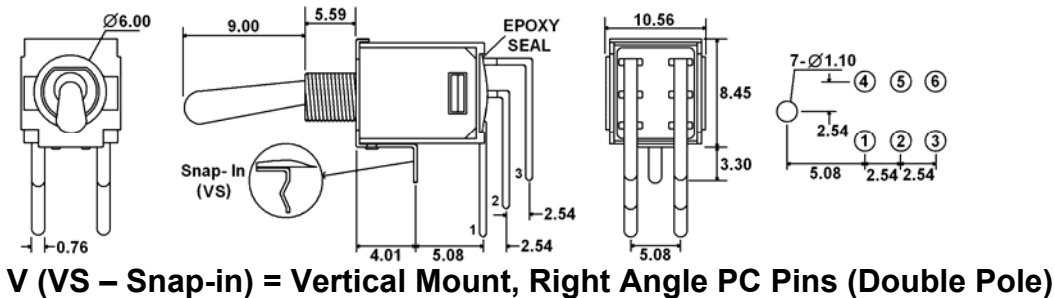
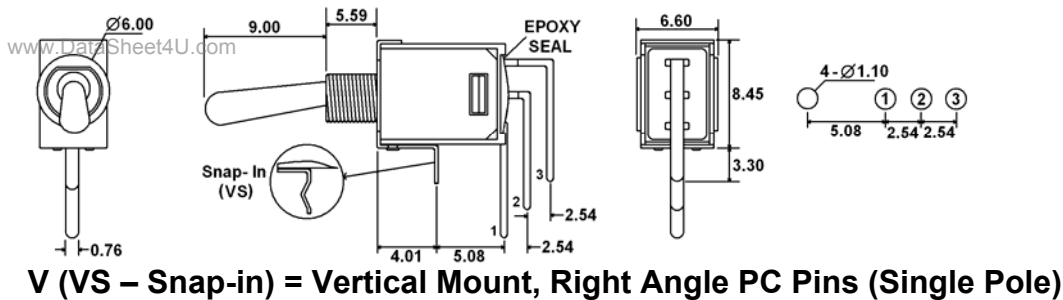
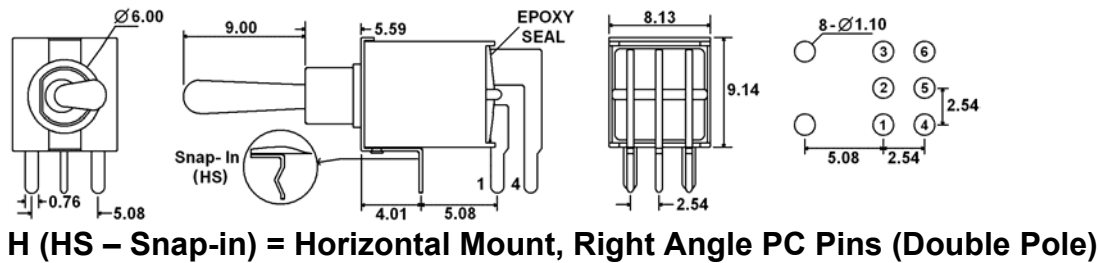
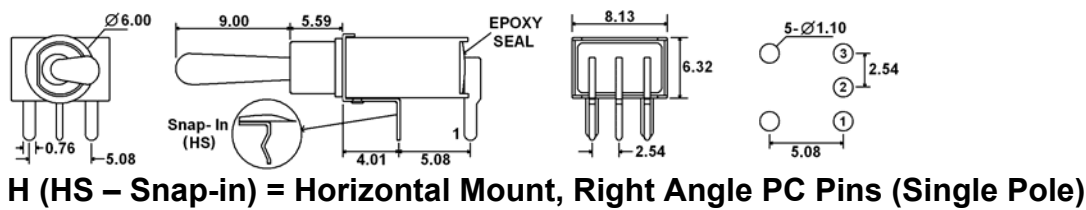
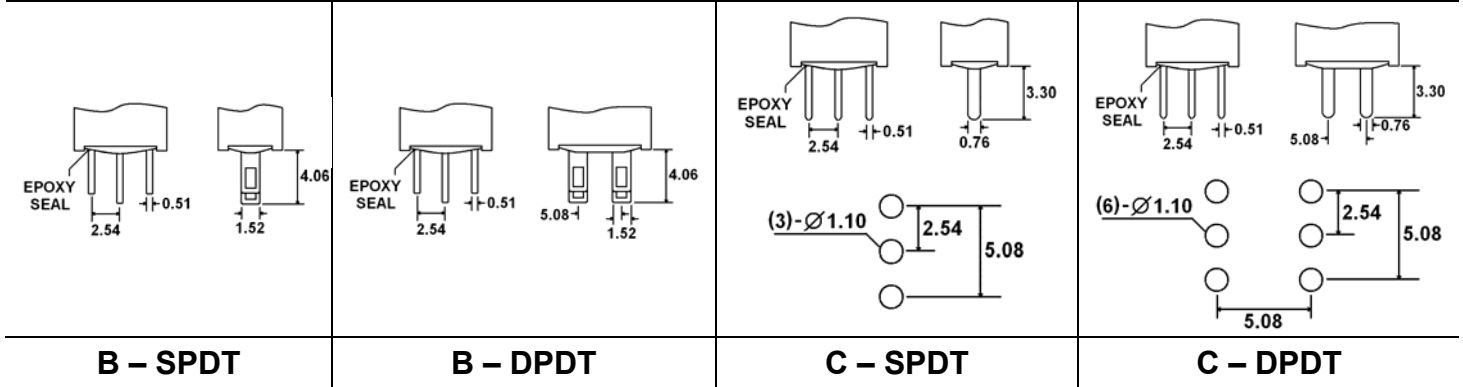

TERMINAL OPTIONS

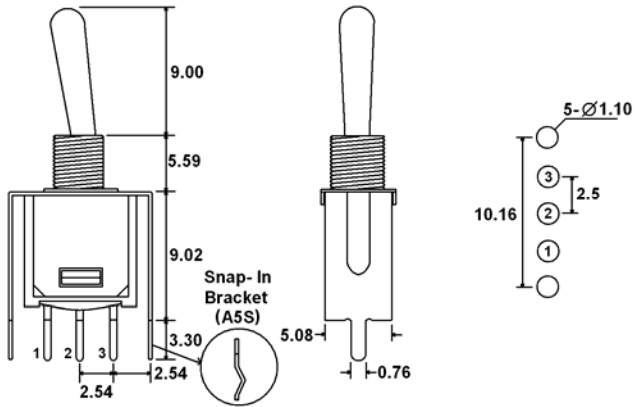

A5 (A5S – Snap-in Bracket)
PC Pins with Support Bracket (Single Pole)

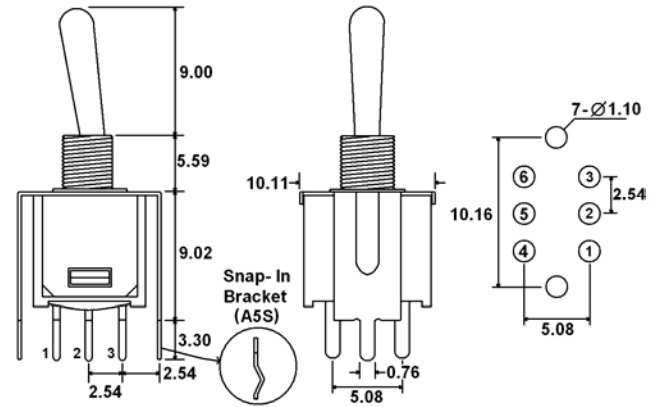

A5 (A5S – Snap-in Bracket)
PC Pins with Support Bracket (Double Pole)

CONTACT OPTIONS

Designator	Contact Material	Terminal Material	Electrical Ratings
Q	Silver Plating	Silver Plating	3A @ 120VAC, 28VDC; 1A @ 250VAC
R	Gold over Nickel Plating	Gold over Nickel Plating	.4 VA max @ 20VAC or VDC max
G	Gold over Silver Plating	Gold over Silver Plating	.4 VA max @ 20VAC or VDC max or 3A @ 120VAC, 28VDC; 1A @ 250VAC

THREE WAY WIRING DIAGRAM

www.DataSheet4U.com

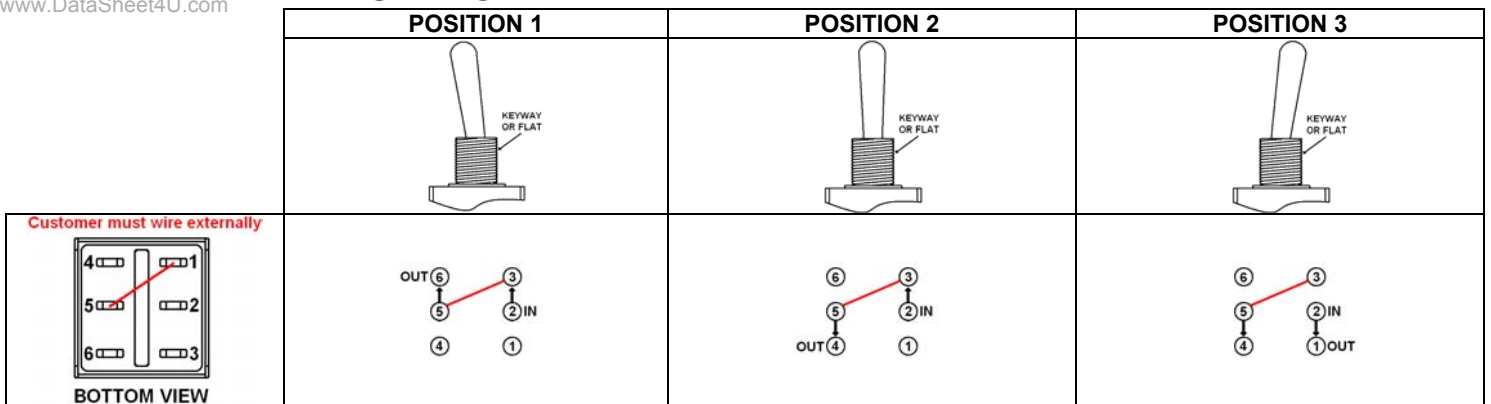

HARDWARE **Two hex nuts, one lock washer, & one locking ring supplied standard with threaded bushings

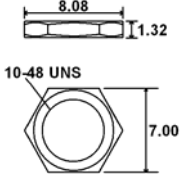
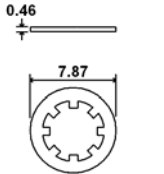
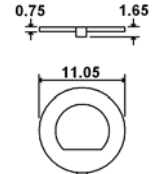
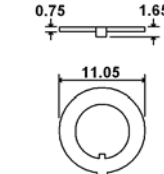
 <p>Hex Nut</p>	 <p>Lock Washer</p>	 <p>Locking Ring</p>	 <p>Locking Ring</p>
---	--	---	---

**For use with E & F Bushings

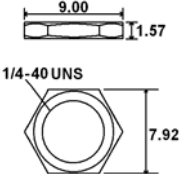
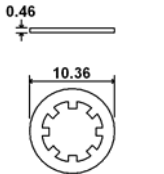
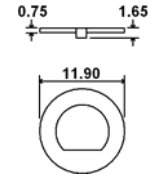
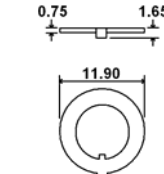
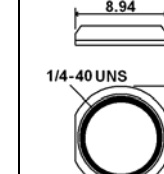
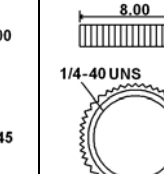
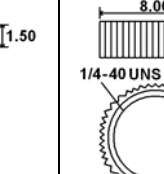
 <p>Hex Nut</p>	 <p>Lock Washer</p>	 <p>Locking Ring</p>	 <p>Locking Ring</p>	 <p>Dress Nut</p>	 <p>Knurled Nut</p>	 <p>Knurled Nut</p>
---	--	---	---	---	--	--

**For use with G & J Bushings