



BC817

NPN SILICON TRANSISTOR

NPN GENERAL PURPOSE AMPLIFIER

■ DESCRIPTION

The UTC **BC817** is designed for general purpose medium power amplifiers and switches requiring collector currents to 1.2A.

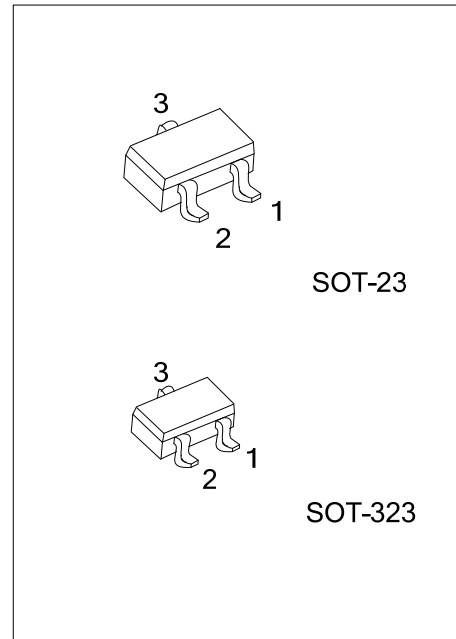

Lead-free: BC817L
Halogen-free: BC817G

■ ORDERING INFORMATION

| Ordering Number | | | Package | Pin Assignment | | | Packing |
|-----------------|----------------|----------------|---------|----------------|---|---|-----------|
| Normal | Lead Free | Halogen Free | | 1 | 2 | 3 | |
| BC817-x-AE3-R | BC817L-x-AE3-R | BC817G-x-AE3-R | SOT-23 | E | B | C | Tape Reel |
| BC817-x-AL3-R | BC817L-x-AL3-R | BC817G-x-AL3-R | SOT-323 | E | B | C | Tape Reel |

| | |
|--|--|
| <p>BC817L-x-AE3-R</p> <p>(1)Packing Type (2)Package Type (3)Rank (4)Lead Plating</p> | <p>(1) R: Tape Reel (2) AE3: SOT-23, AL3: SOT-323 (3) x: refer to Classification of h_{FE} (4) G: Halogen Free, L: Lead Free, Blank: Pb/Sn</p> |
|--|--|

■ MARKING

| BC817-16 | BC817-25 | BC817-40 |
|---|---|---|
| <p>L: Lead Free G: Halogen Free</p> | <p>L: Lead Free G: Halogen Free</p> | <p>L: Lead Free G: Halogen Free</p> |

■ ABSOLUTE MAXIMUM RATINGS (Ta=25°C, unless otherwise specified)

| PARAMETER | | SYMBOL | RATINGS | UNIT |
|-------------------------------|---------|-----------|------------|------|
| Collector-Base Voltage | | V_{CES} | 50 | V |
| Collector-Emitter Voltage | | V_{CEO} | 45 | V |
| Emitter-Base Voltage | | V_{EBO} | 5.0 | V |
| Collector Current -Continuous | | I_C | 1.5 | A |
| Collector Dissipation | SOT-23 | P_C | 310 | mW |
| | SOT-323 | | 200 | mW |
| Junction Temperature | | T_J | +150 | °C |
| Storage Temperature | | T_{STG} | -65 ~ +150 | °C |

Note: Absolute maximum ratings are those values beyond which the device could be permanently damaged.

Absolute maximum ratings are stress ratings only and functional device operation is not implied.

■ ELECTRICAL CHARACTERISTICS (Ta=25°C, unless otherwise specified)

| PARAMETER | SYMBOL | TEST CONDITIONS | MIN | TYP | MAX | UNIT |
|--------------------------------------|---------------|-------------------------------|--------------------|-----|-----|---------|
| OFF CHARACTERISTICS | | | | | | |
| Collector-Emitter Breakdown Voltage | BV_{CEO} | $I_C=10mA, I_B=0$ | 45 | | | V |
| Collector-Base Breakdown Voltage | BV_{CES} | $I_C=100\mu A, I_E=0$ | 50 | | | V |
| Emitter-Base Breakdown Voltage | BV_{EBO} | $I_E=10\mu A, I_C=0$ | 5 | | | V |
| Collector Cut-OFF Current | I_{CBO} | $V_{CB}=20V$ | | | 100 | nA |
| | | $V_{CB}=20V, T_a=150^\circ C$ | | | 5 | μA |
| ON CHARACTERISTICS | | | | | | |
| DC Current Gain | h_{FE1} | $I_C=100mA, V_{CE}=1.0V$ | See Classification | | | |
| | h_{FE2} | $I_C=500mA, V_{CE}=1.0V$ | 40 | | | |
| Collector-Emitter Saturation Voltage | $V_{CE(SAT)}$ | $I_C=500mA, I_B=50mA$ | | | 0.7 | V |
| Base-Emitter On Voltage | $V_{BE(ON)}$ | $I_C=500mA, V_{CE}=1.0V$ | | | 1.2 | V |

■ CLASSIFICATION OF h_{FE1}

| RANK | 16 | 25 | 40 |
|-------|---------|---------|---------|
| RANGE | 100-250 | 160-400 | 250-600 |

TYPICAL CHARACTERISTICS

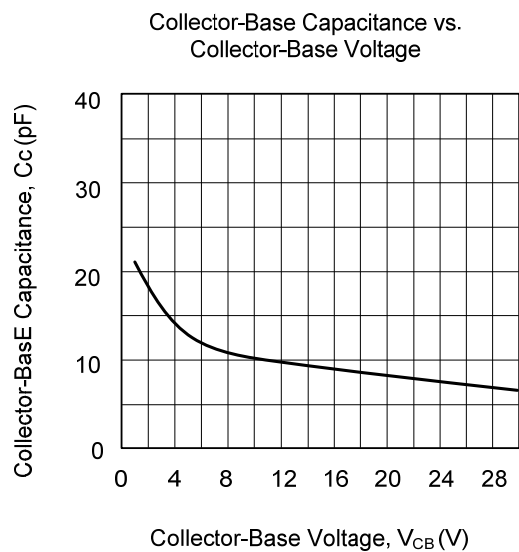
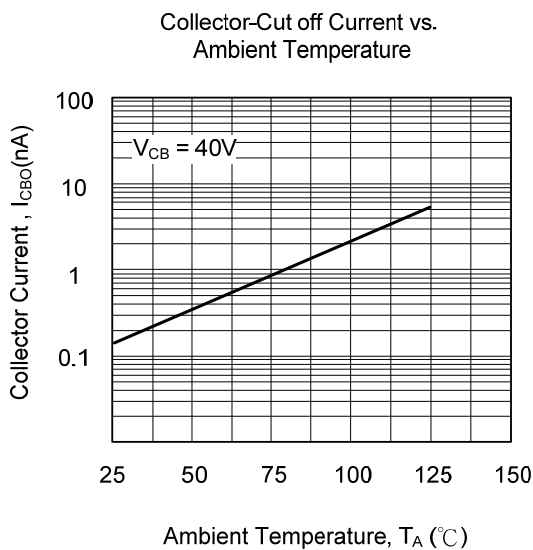
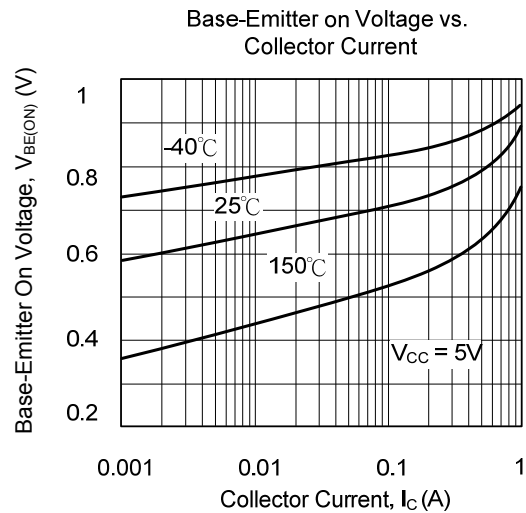
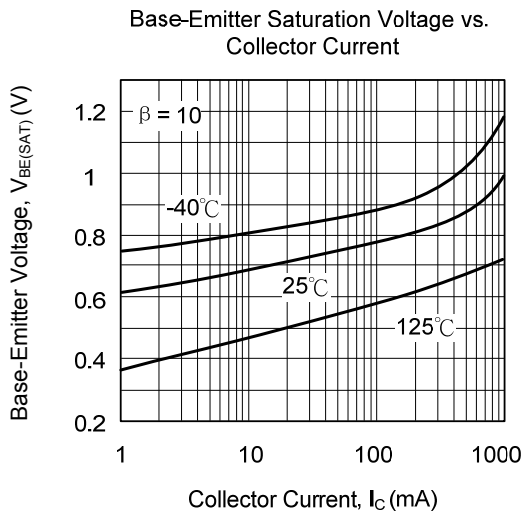
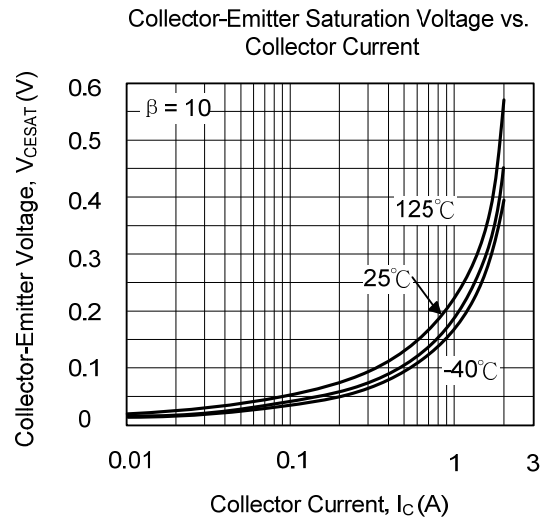
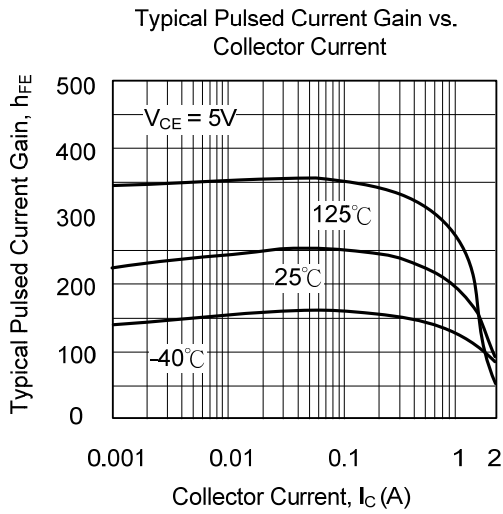

■ TYPICAL CHARACTERISTICS(Cont.)

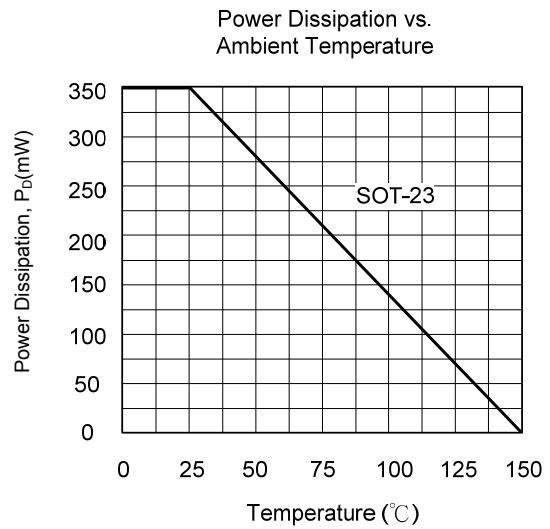
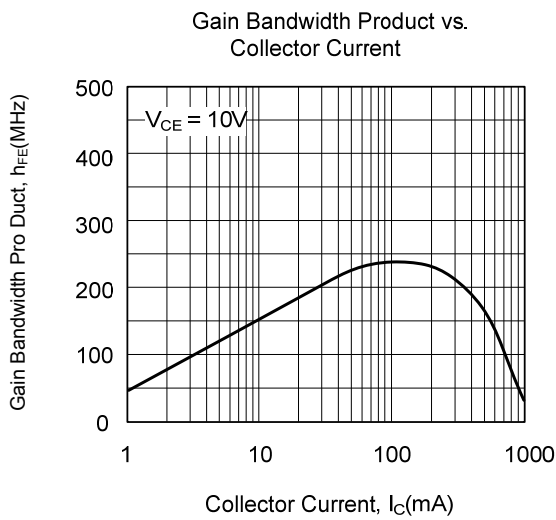

UTC assumes no responsibility for equipment failures that result from using products at values that exceed, even momentarily, rated values (such as maximum ratings, operating condition ranges, or other parameters) listed in products specifications of any and all UTC products described or contained herein. UTC products are not designed for use in life support appliances, devices or systems where malfunction of these products can be reasonably expected to result in personal injury. Reproduction in whole or in part is prohibited without the prior written consent of the copyright owner. The information presented in this document does not form part of any quotation or contract, is believed to be accurate and reliable and may be changed without notice.