

Series 171 MicroStrips Single Row Strips with Insulated Wire

171-003

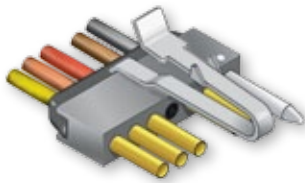

Micro-D
Latching
MicroStrips



171-003-7P-6K7-18-P1CL

Single Row MicroStrips with Insulated Stranded Wire

These .050" pitch single row microstrips are factory-terminated to military-grade hookup wire. Crimp termination. Available with 1 to 30 contacts. Optional latching mechanism prevents de-mating. Guide pins provide circuit polarization. Contacts are twistpin type and are gold-plated. Housing is molded LCP thermoplastic. Available with standard M22759/11 ETFE wire, or upgrade to M22759/33 space grade wire. Suitable for high-reliability applications where long-term resistance to fretting corrosion is a necessity. 3 A., 600 Vac, -55C to +150C. Wire is 600V, 200C.

How To Order Single Row Microstrips With Insulated Wire

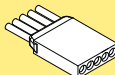
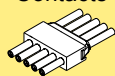
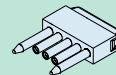
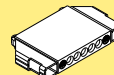
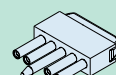
Series	Number of Cavities	Contact Type	Wire Gage	Wire Type	Wire Color Code	Wire Length	Optional Guide Pin	Optional Latch	Optional Mounting Holes
171-003 Single Row MicroStrip, .050" Contact Spacing, Pre-Wired, Stranded Wire	Total Number of Cavities including guide pins, latches and mounting holes. The number of cavities equals the number of electrical circuits plus 1 cavity for each guide pin and latch, plus 6 cavities for the mounting hole option.	P Pin Contacts  S Socket Contacts 	-4 #24 AWG	K Standard Wire	1 White	Wire Length In Inches Example: -18 18 inches 6, 12 and 18 are frequently used lengths.	Omit For No Guide Pin	Omit For No Latch	Omit For No Mounting Holes
			-6 #26 AWG	Extruded PTFE per M22759/11, Silver-Plated Conductors (#30 AWG not available)	5 Color-Coded per MIL-STD-681				
			-8 #28 AWG	J Space Grade Wire	Wires 1-10 are solid color, 11-up are striped.				
			-0 #30 AWG	High Strength, Lightweight, Crosslinked Modified ETFE per M22759/33, Silver-Plated Conductors	7 10 Color Repeat				
Sample Part Number							-PB Guide Pin at Both Ends 	BL Latch at Both Ends 	The three cavities on each end are filled with epoxy. Two .062" (1.57mm) holes are cross-drilled to allow for attachment to a mounting surface.
							-P(X) Replace (X) with guide pin location. P3 shown below: 		
171-003	-7	P	-6	K	7	-18	-P1	CL	

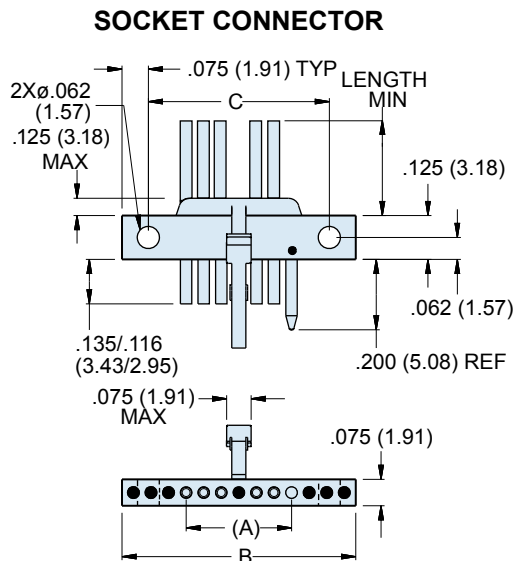
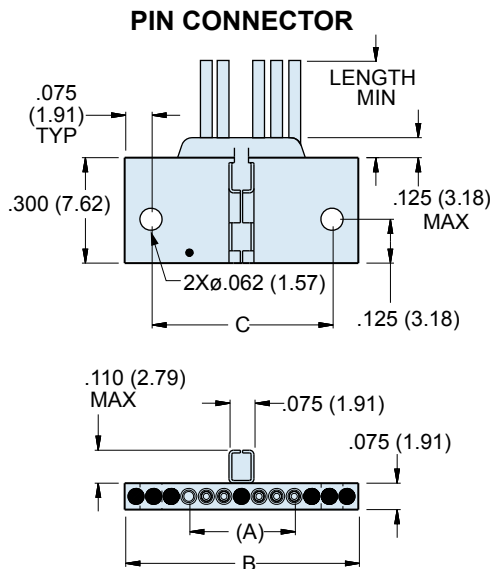

Dimensions

# of Cavities	(A)		B Max.		C		# of Cavities	(A)		B Max.		C	
	In.	mm.	In.	mm.	In.	mm.		In.	mm.	In.	mm.	In.	mm.
1	-	-	.085	2.16	N/A	N/A	16	.750	19.05	.835	21.21	.650	16.51
2	.050	1.27	.135	3.43	N/A	N/A	17	.800	20.32	.885	22.48	.700	17.78
3	.100	2.54	.185	4.70	N/A	N/A	18	.850	21.59	.935	23.75	.750	19.05
4	.150	3.81	.235	5.97	N/A	N/A	19	.900	22.86	.985	25.02	.800	20.32
5	.200	5.08	.285	7.24	N/A	N/A	20	.950	24.13	1.035	26.29	.850	21.59
6	.250	6.35	.335	8.51	N/A	N/A	21	1.000	25.40	1.085	27.56	.900	22.86
7	.300	7.62	.385	9.78	.200	5.08	22	1.050	26.67	1.135	28.83	.950	24.13
8	.350	8.89	.435	11.05	.250	6.35	23	1.100	27.94	1.185	30.10	1.000	25.4
9	.400	10.16	.485	12.32	.300	7.62	24	1.150	29.21	1.235	31.37	1.050	26.67
10	.450	11.43	.535	13.59	.350	8.89	25	1.200	30.48	1.285	32.64	1.100	27.94
11	.500	12.70	.585	14.86	.400	10.16	26	1.250	31.75	1.335	33.91	1.150	29.21
12	.550	13.97	.635	16.13	.450	11.43	27	1.300	33.02	1.385	35.18	1.200	30.48
13	.600	15.24	.685	17.40	.500	12.7	28	1.350	34.29	1.435	36.45	1.250	31.75
14	.650	16.51	.735	18.67	.550	13.97	29	1.400	35.56	1.485	37.72	1.300	33.02
15	.700	17.78	.785	19.94	.600	15.24	30	1.450	36.83	1.535	38.99	1.350	34.29

Center Latch Locations

Even Number of Cavities

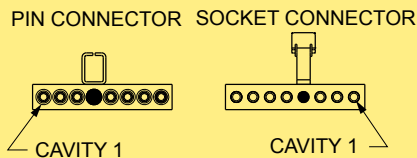

Latch placed on next lower cavity prior to centerline.
 Latch position = (# of Cavities) ÷ 2.

Odd Number of Cavities

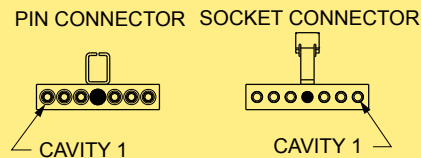

Latch placed in cavity on centerline.
 Latch Position = (# of Cavities+1) ÷ 2.