



SPEC. NO	
ISSUED DATE	

CUSTOMER	:	
M O D E L	:	OGM-128GS24Y-1-C4021
DESCRIPTION	:	LCD MODULE

THIS SPECIFICATION IS APPLIED FOR LCD MODULE DELIVERED TO YOUR COMPANY BY ORION DISPLAY TECHNOLOGY CO., LTD

◆ CUSTOMER APPROVAL

	CHECKED	CHECKED	APPROVAL
APPROVAL			
REMARK			

◆ SUPPLIER APPROVAL

PREPARED	CHECKED		APPROVAL

ADDRESS : ORION DISPLAY TECHNOLOGY CO., LTD
 257-3, GONGDAN-DONG, GUMI, KYUNG-BUK, KOREA
 (TEL) 82-546-467-5420~9 (FAX) 82-546-462-2496

	LCD MODULE SPECIFICATION FOR APPROVAL	ISSUED DATE	
	OGM-128GS24Y-1-C4021	REV. NO.	0
		PAGE	3 OF 12

CONTENTS

1. FEATURES	-----	4
2. MECHANICAL SPECIFICATION	-----	4
3. ABSOLUTE MAXIMUM RATINGS	-----	5
4. ELECTRICAL CHARACTERISTICS	-----	5
5. ELECTRO-OPTICAL CHARACTERISTICS	-----	6
6. QUALITY SPECIFICATION	-----	7
7. RELIABILITY	-----	10
8. PIN CONNECTIONS	-----	10
9. PRECAUTION FOR USING	-----	11
10. EXTERNAL DIMENSION	-----	12

NOTE: When using this specification, the reader should keep the followings in mind.

1. This specification may, wholly or partially, be subjected to change without notice.
2. Information contained herein is proprietary information of ORION DISPLAY TECHNOLOGY CO.,LTD. The dissemination use or duplication for any purpose other than for which the information is provided is prohibited by ORION DISPLAY TECHNOLOGY CO., LTD except by express permission.

	LCD MODULE SPECIFICATION FOR APPROVAL	ISSUED DATE	
	OGM-128GS24Y-1-C4021	REV. NO.	0
		PAGE	4 OF 12

1. FEATURES

- 1) Number of dot ----- 240 x 128 dots
- 2) Display mode ----- STN-GREY
- 3) Display type ----- Transflective, Positive
- 4) Viewing direction ----- 6 o'clock
- 5) Operating temperature ----- Indoor
- 6) Drving voltage ----- Double power
- 7) Driving method ----- 1/128 duty
- 8) Type ----- QFP (Quad Flat Package)
- 9) Number of data line ----- 8-bit parallel
- 10) Applicated IC ----- T6963C or equivalent
- 11) Backlighting ----- CCFL (Emitng color : White)

2. MECHANICAL DATA

ITEM		WIDTH	HEIGHT	THICKNESS	UNIT
Module size		170.0	105.0	14.0	mm
Viewing area		126.0	70.0	-	mm
Dot	Size	0.47	0.47	-	mm
	Pitch	0.50	0.50	-	mm
Diameter of mounting hole		4-3.5			mm
Weight		About 250			g

	LCD MODULE SPECIFICATION FOR APPROVAL		ISSUED DATE	
	OGM-128GS24Y-1-C4021		REV. NO.	0
			PAGE	5 OF 12

3. ABSOLUTE MAXIMUM RATINGS

ITEM	SYMBOL	CONDITION	STANDARD VALUE		UNIT
			MIN.	MAX.	
Power supply for logic	$V_{DD}-V_{SS}$	$T_a=25^{\circ}\text{C}$	0	7.0	V
Power supply for LCD	$V_{DD}-V_{EE}$	$T_a=25^{\circ}\text{C}$	0	24.0	V
Input voltage	V_{IN}	$T_a=25^{\circ}\text{C}$	V_{SS}	V_{DD}	V
Operating temperature	T_{op}	-	0	50	$^{\circ}\text{C}$
Storage temperature	T_{STG}	-	-20	70	$^{\circ}\text{C}$

4. ELECTRICAL CHARACTERISTICS

ITEM	SYMBOL	CONDITION	STANDARD VALUE			UNIT
			MIN.	TYP.	MAX.	
Power supply for logic	V_{DD}	$T_a = 25^{\circ}\text{C}$	4.75	5	5.25	V
Input high voltage	V_{IH}	-	$V_{DD}-2.2$	-	V_{DD}	V
Input low voltage	V_{IL}	-	V_{SS}	-	0.8	V
Output high voltage	V_{OH}	$I_{OH} = 0.6\text{mA}$	$V_{DD}-0.4$	-	V_{DD}	V
Output low voltage	V_{OL}	$I_{OL} = 0.6\text{mA}$	V_{SS}	-	0.4	V
Power supply current	I_{DD}	$V_{DD}=5.0\text{V}, V_{LCD}=17.5\text{V}$	-	13.0	20.0	mA
CCFL operating voltage	V_{FL}	$I_{FL}=5\text{mA}$	250	360	580	V_{rms}
CCFL operating current	I_{FL}	$V_{FL}=360\text{V}$	3.0	5.0	7.0	mA
CCFL frequency	fFL	-	20	45	-	KHz
Brightness	1	$I_{FL}=5\text{mA}$	40	55	-	Nit
Power supply for LCD (Note 1) = V_{LCD}	$V_{DD}-V_L$	$T_a = 0^{\circ}\text{C}$	-	-	-	V
		$T_a = 25^{\circ}\text{C}$	-	17.5	-	V
		$T_a = 50^{\circ}\text{C}$	-	-	-	V

Note 1 : Power supply for LCD is available with R_L in accordance with contrast.

	LCD MODULE SPECIFICATION FOR APPROVAL	ISSUED DATE	
	OGM-128GS24Y-1-C4021	REV. NO.	0
		PAGE	6 OF 12

5. ELECTRO-OPTICAL CHARACTERISTICS (STN) (Ta = 25 °C)

ITEM	SYMBOL	MIN.	TYP.	MAX.	UNIT	NOTE
Contrast ratio	K	2	4	-	-	3
Response time (rise)	T_r	-	200	250	ms	4
Response time (fall)	T_f	-	200	250	ms	4
Viewing angle	ϕ	-10 ~ +40			deg.	1.2
	θ	-40 ~ +40				

NOTE1. Definition of contrast K

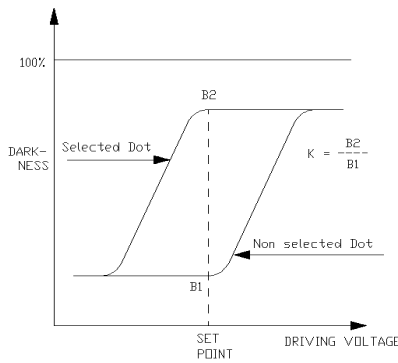

NOTE2. Definition of optical response

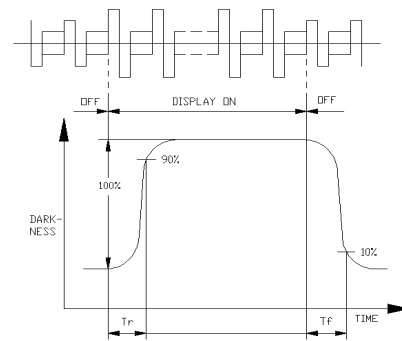

NOTE3. Definition of angle θ and ϕ

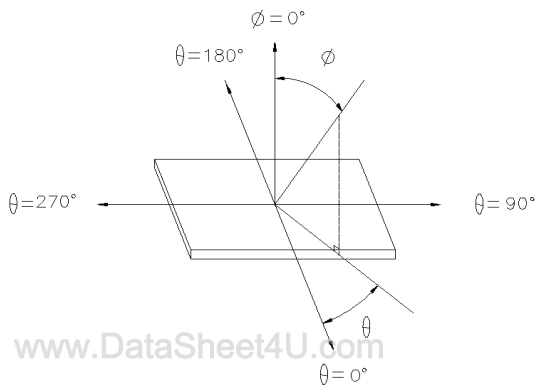

NOTE4. Definition of viewing angle ϕ_1 and ϕ_2

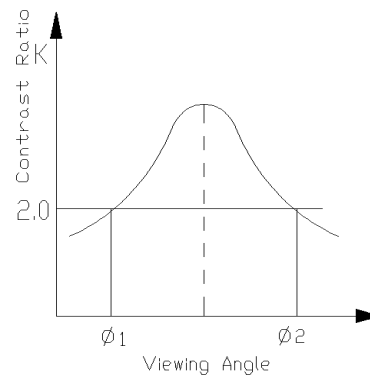

	LCD MODULE SPECIFICATION FOR APPROVAL	ISSUED DATE	
	OGM-128GS24Y-1-C4021	REV. NO.	0
		PAGE	7 OF 12

6. QUALITY SPECIFICATION

6.1 Acceptable Quality Level

INSPECTION ITEM	SAMPLING PROCEDURES	A.Q.L
MAJOR	MIL-STD-105E Inspection Level II Normal Inspection Single sample inspection	1.0
MINOR	MIL-STD-105E Inspection Level II Normal Inspection Single sample inspection	2.5

Major defect :

A major defect is a defect that could result in failure or materially reduce that the usability of the unit of product for its intended purpose.

Minor defect :

A minor defect is one that does not materially reduce the usability of the product for its intended purpose or is a departure from established standards giving no significant bearing on the effective use or operation of the unit.

6.2 Inspection Conditions

6.2.1 The environmental conditions for inspection shall be as follows

- Room Temperature : $25 \pm 3^{\circ}\text{C}$
- Humidity Temperature : $65 \pm 20\% \text{RH}$

6.2.2 The external visual inspection

- The inspection shall be performed by using 40Watts fluorescent lamp for illumination and the distance between LCD and eyes of the inspector shall be 30cm or more.

6.3 Definition of the Area

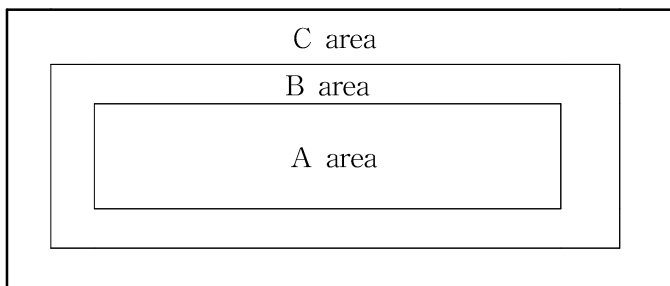

A area: Active Area
 B area: Viewing Area
 C area: Out of Viewing Area

	LCD MODULE SPECIFICATION FOR APPROVAL	ISSUED DATE	
	OGM-128GS24Y-1-C4021	REV. NO.	0
		PAGE	8 OF 12

6.4 Inspection Standards

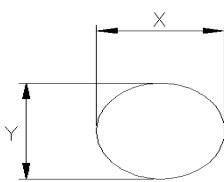
Class of defects	Inspection Item	Criteria of defects		Remarks	
MAJOR	Display on inspection	1) No Display 2) Abnormal Operation 3) Short Circuit 4) Pattern Open 5) Off Viewing angle			
	Missing	Component missing			
MINOR	Spot/Dent	Size	Defect size	Acceptable Number	
		A Size	$\phi \leq 0.1 \text{ mm}$	Ignore	
			$0.1 < \phi \leq 0.2 \text{ mm}$	1	
			$\phi > 0.2 \text{ mm}$	0	
		B Size	$\phi \leq 0.1 \text{ mm}$	Ignore	
			$0.1 < \phi \leq 0.2 \text{ mm}$	2	
	$\phi > 0.2 \text{ mm}$		0		
	Cell Size (Viewing Area Criteria) ※ A size $< 2500\text{mm}^2$ Spot size = $(X+Y)/2$ B size $\geq 2500\text{mm}^2$				
	Scratch	POSITIVE		NEGATIVE	
		Width X Length	Acceptable Number	Width X Length	Acceptable Number
0.1 X 1.5 mm		3	0.1 X 1.5 mm	3	
0.08 X 3.0 mm		2	0.08 X 3.0 mm	2	
0.05 X 5.0 mm		1	0.05 X 5.0 mm	1	
※ Scratches should be separated more than 10mm each other					
Bubble	1) Round bubble should be treated as spot(positive) 2) Line bubble should be treated as scratch(positive)				

	LCD MODULE SPECIFICATION	ISSUED DATE	
	FOR APPROVAL	REV. NO.	0
	OGM-128GS24Y-1-C4021	PAGE	9 OF 12

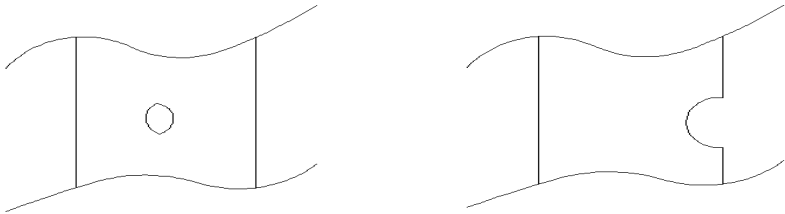
Class of defects	Inspection Item	Criteria of defects	Remarks
MINOR	Pattern Misalignment	Voids in segment 	
	Stain	Stains which cannot be removed even when wiped slightly with a soft cloth.	
	Rainbow	More than 2 colors are noticeable in the viewing direction.	
MINOR	PCB damage	Damage on gold or copper foil	
	Parts alignment	1) IC lead width is more than 50% beyond land pattern 2) Chip component is off center and more than 50% of the leads is off the pad out line.	
	Conductive foreignmatter (solderball, soldersplash)	Conductive foreign matter is not allowed	
	Bezel claw	Bezel claw missing or not bent	

	LCD MODULE SPECIFICATION FOR APPROVAL	ISSUED DATE	
	OGM-128GS24Y-1-C4021	REV. NO.	0
		PAGE	10 OF 12

7. RELIABILITY

ITEM	TEST	CRITERION
High temp.	70°C / 200 Hrs	* Total current consumption should be below double of initial value
Low temp.	-20°C / 200 Hrs	
High humidity	40°C X 90%RH / 200 Hrs	
Thermal shock	-20°C → 25°C → 70°C → 25°C / 5 Cycles (20min) (5min) (30min) (5min)	* Contrast ratio should be within initial value ±50%
Vibration	1.Operating time : Thirty minutes exposure for each direction(x,y,z) 2.Sweep frequency (1min) : 10Hz →55Hz →10Hz 3.Amplitude : 0.75mm	* No defect in cosmetic and operational function is allowable

* Remarks : Samples subjected to the tests shall be “ Not operating ” condition .

8. PIN CONNECTIONS

PIN NO.	SYMBOL	FUNCTION	
1	FGND	Frame ground	
2	GND	-	Ground
3	VDD	+5V	Power supply for logic
4	VL	-	Operating voltage for LCD driving
5	WR	Data write (Write data into T6963C at "L")	
6	RD	Data read (Read data from T6963C at "L")	
7	CE	Chip enable for T6963C. CE must be "L":when CPU communicates with T6963C	
8	C/D	WR="L"--"H": Command write "L": Data write RD="L"--"H": status read "L": Data read	
9	N/C	Non-connection	
10	RESET	"H": Normal (T6963C has internal pull up resistance) "L": Initialize T6963C	
11	D0	Data Bus Line	
~	~		
18	D7		
19	FS	Selection of columns--"H":6x8 char., "L":8x8 char.	
20	RV	Reverse (H ; black character, L : white character)	
21	VFL	Power supply for CCFL (HOT)	
22	VFL	Power supply for CCFL (GND)	

9. BLOCK DIAGRAM

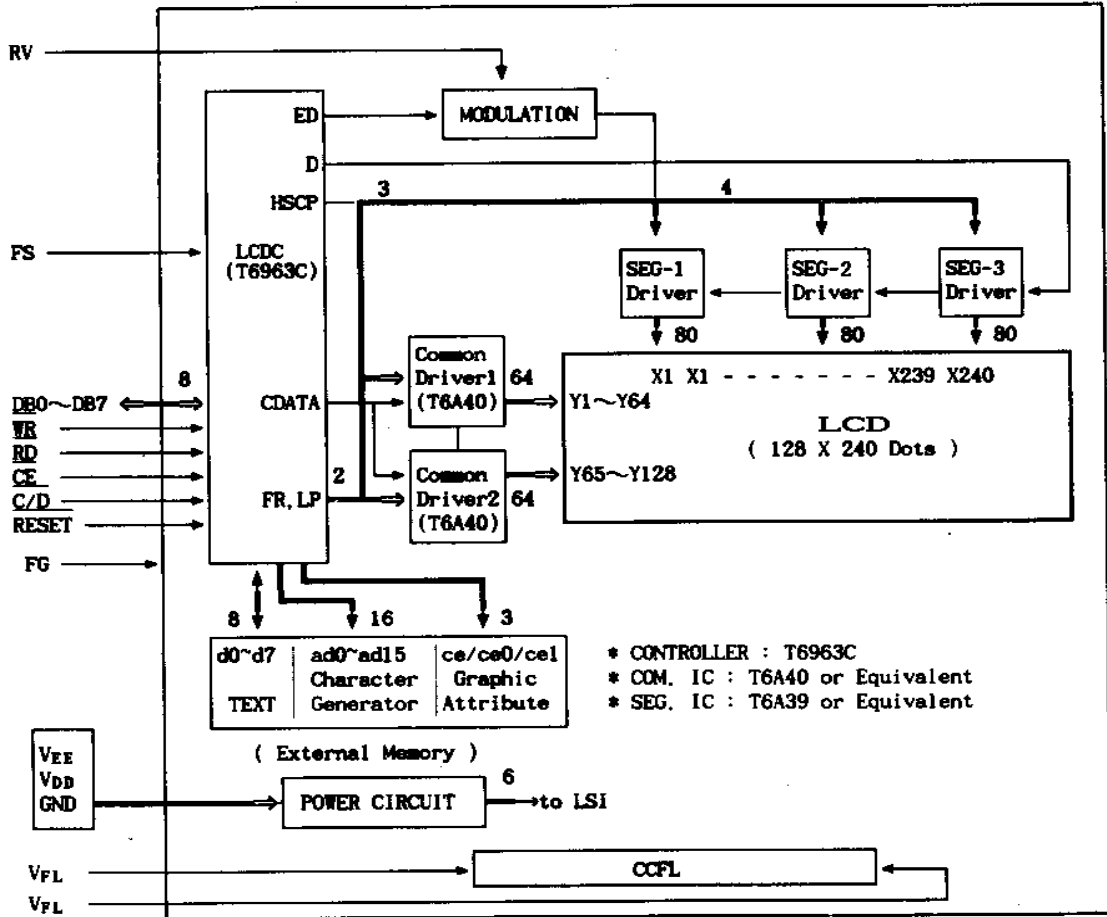

10. POWER SUPPLY

(DOUBLE POWER)

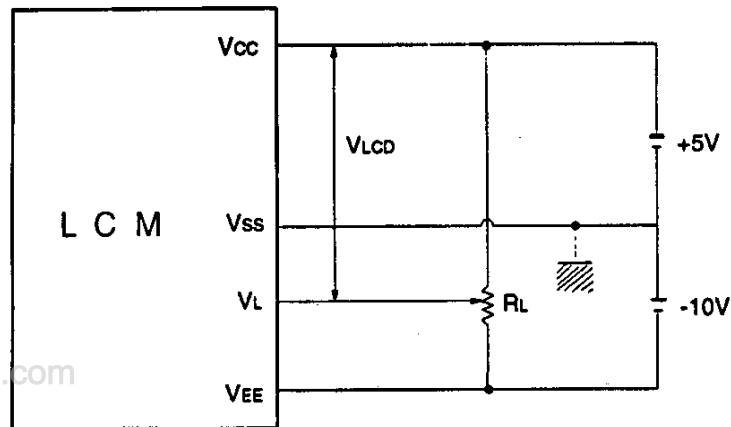

($R_L = 10 \sim 20 \text{ K}\Omega$)

	LCD MODULE SPECIFICATION FOR APPROVAL	ISSUED DATE	
	OGM-128GS24Y-1-C4021	REV. NO.	0
		PAGE	12 OF 12

11. TIMING CHARACTERISTICS

ITEM	SYMBOL	Min.	Max.	Unit
C/D Set Up Time	t_{CDS}	100	-	nS
C/D Hold Time	t_{CDH}	10	-	nS
CE, RD, WR Pulse Width)	t_{CE}, t_{RD}, t_{WR}	80	-	nS
Data Set Up Time	t_{DS}	80	-	nS
Data Hold Time	t_{DH}	40	-	nS
Access Time	t_{ACC}	-	150	nS
Output Hold Time	t_{OH}	10	50	nS

BUS TIMING

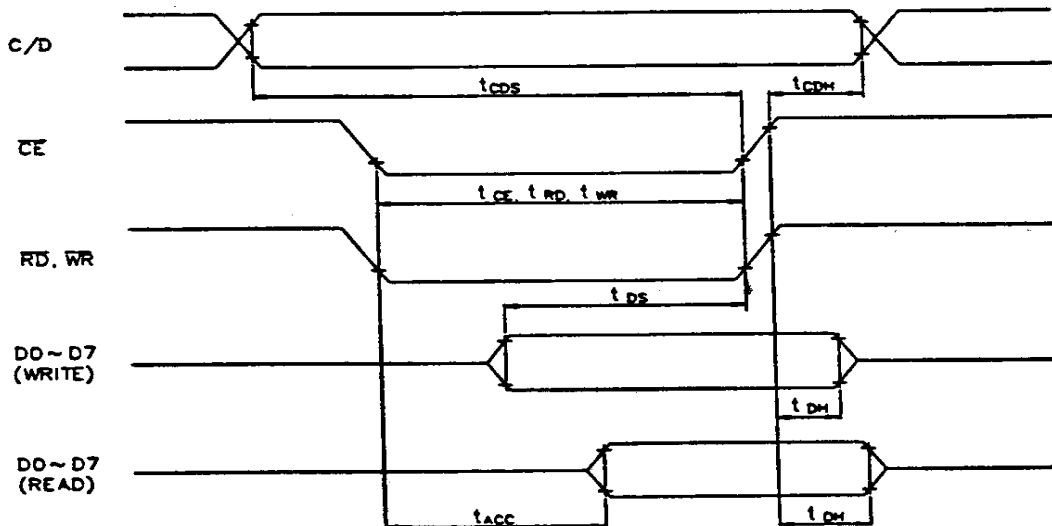

	LCD MODULE SPECIFICATION FOR APPROVAL	ISSUED DATE	
	OGM-128GS24Y-1-C4021	REV. NO.	0
		PAGE	13 OF 12

12. PRECAUTION FOR USING

16.1 HANDLING

- 1) Refrain from storing mechanical shock and from applying any force to LCD MODULE.
It may cause mis_operation or damage of LCD.
- 2) Do not touch, press or rub the display panel with a hard, stiff tool or object as the polarizers in the panel are easily scratched.
- 3) If LCD is broken and liquid crystal material flow out, ingestion, inhalation, or contact with skin should be avoided. If liquid crystal material contact with skin, wash immediately with alcohol and rinse thoroughly with water.
- 4) Never use organic solvents to clear the display panel as these solvent may adversely affect the polarizer. To clean the display panel dampen a bit of absorbent cotton with petroleum benzene and gently wipe the panel, or contaminations by using a scotch tape.
- 5) Refrain from discharge of high electro-static voltage, it will damage C-MOS LSI in the MODULE.
- 6) Do not leave the MODULE in high temperature, especially in high humidity for a long time. It is recommended to store the MODULE where the temperature is in the range of 0°C to 35°C and the humidity is lower than 70%.
- 7) Store the MODULE without exposure to direct sunlight or fluorescent lamp.
- 8) Ultra violet cut filter is necessary for outdoor operation.
- 9) Avoid condensation of water, it may cause mis-operation or disconnection of electrode.

16.2 OPERATION

- 1) Never connect or disconnect the LCD MODULE from the main system while power is being supplied.
- 2) When supplying the M signal from the external unit to a GRAPHIC MODULE, set the duty to $50\% \pm 1\%$.
If the duty deviates too greatly from the value, a DC voltage will be applied to the liquid crystal, which could induce an electrochemical reaction and reduce the life of the MODULE.
- 3) Do not exceed the maximum rating values under the worst conditions taking account of the supply voltage variation, input voltage variation, and environmental temperature, etc. Otherwise LCD module may be damaged.

	LCD MODULE SPECIFICATION FOR APPROVAL	ISSUED DATE	
	OGM-128GS24Y-1-C4021	REV. NO.	0
		PAGE	14 OF 12

13. EXTERNAL DIMENSION

