

DS0475 SP5T

- 200 - 800 MHz
- TTL DRIVER
- 24 PIN DIP PACKAGE

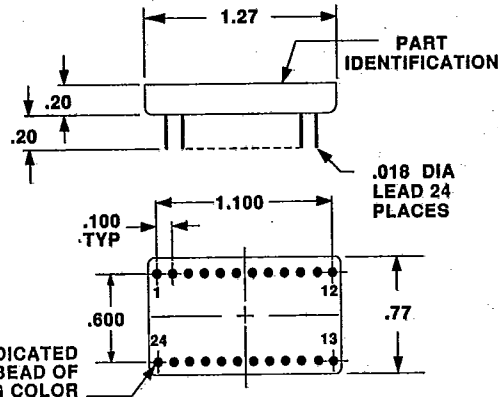

PIN 24 IS INDICATED BY GLASS BEAD OF CONTRASTING COLOR

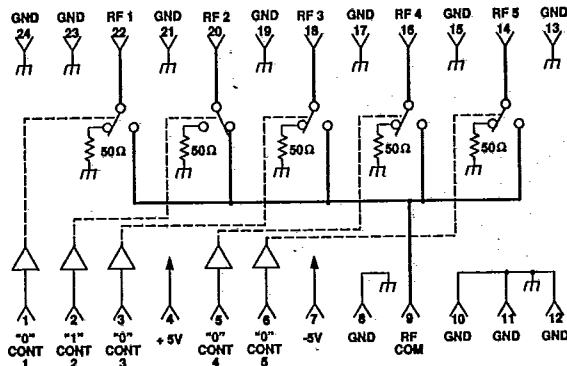
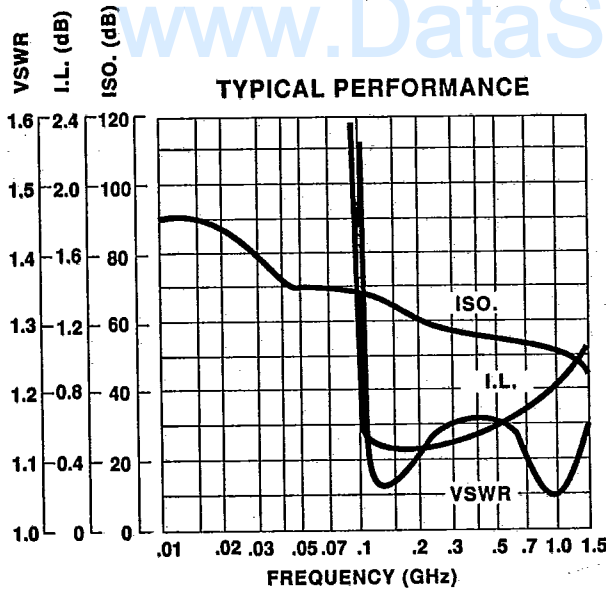

OPERATING CHARACTERISTICS

PARAMETER	MIN	TYP	MAX	UNITS	CONDITIONS
CURRENT DRAIN		20	27	mA	AT +5V DC SUPPLY
		20	27	mA	AT -5V DC SUPPLY
INTERCEPT POINT, 2ND		+58		dBm	AT 200/300 MHz IN
3RD		+39		dBm	AT 200/350 MHz IN
SWITCHING TRANSIENTS		100		mV	PEAK VALUE
TRANSITION TIME		40		nSEC	10%/90% OR 90%/10% RF
SWITCHING SPEED		0.3	1.0	μSEC	50% TTL TO 90%/10% RF
CONTROL CURRENT, HI			40	μA	V _{IH} = 2.7V
LO			-400	μA	V _{IL} = 0.5V
INSERTION LOSS		0.6	1.0	dB	
ISOLATION	40	50		dB	PORT TO PORT
CONTROL LINE ISOLATION	30	40		dB	BIAS & CONTROL TO RF
VSWR		1.15/1	1.3/1		
TERMINATION, VSWR		1.22/1	1.4/1		
IMPEDANCE		50		Ohms	
RF POWER, OPERATE		+23	+10	dBm	.1 DB COMPRESSION
MAXIMUM			+30	dBm	NO DAMAGE
OPERATING FREQUENCY	200		800	MHz	
OPERATING TEMPERATURE	-55	+25	+125	°C	TA

CONTROL: 5 LINE TTL,
LOGIC "1" = ON, LOGIC "0" = OFF

MODEL NO. DS0475



SP5T
200-800 MHz

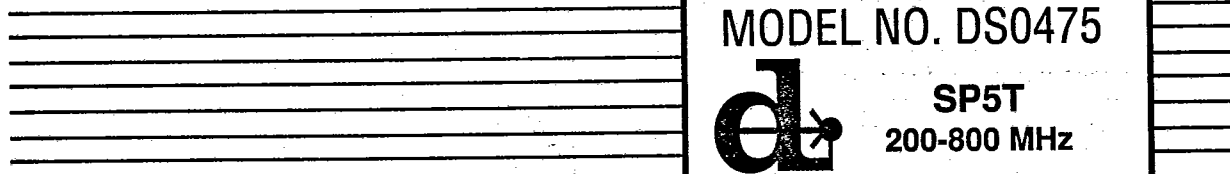



T-90-20

SURFACE MOUNT TECHNOLOGY PACKAGES

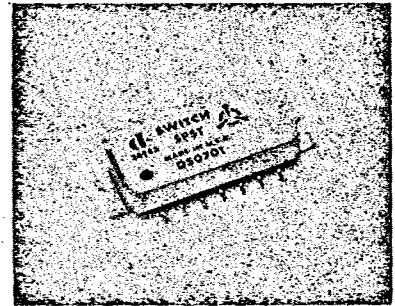
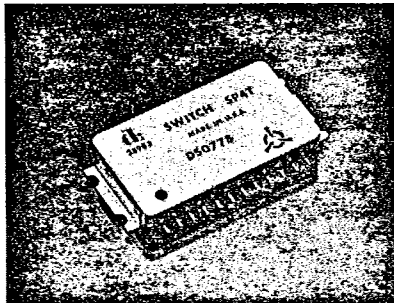

Daico Surface-Mount Products Designed for Military Application

Daico Surface-Mount packages were designed specifically for the military environment and have several advantages over traditional SMT packages.

- Pre-formed leads eliminate the possibility of broken glass seals during forming process.
- Gull-wing type design allows easy soldering and QA inspection of finished solder joints.
- Small lead length between package and board reduces stress on glass seals over thermal cycling and vibration without sacrificing RF performance.
- Mounting tabs allow easy mounting and excellent grounding.
- Gold-plated Kovar for excellent electrical and thermal conductivity meets MIL-STD environmental specifications (salt spray, humidity, etc.).
- Hermetically sealed.

In addition to the devices specified in this section, Daico switches and attenuators currently packaged in standard width 14 pin, 24 pin and 38 pin DIP format are easily converted to surface mount. We are continually adding new Surface-Mount products. For an updated list of available Surface-Mount products, please call or write Daico Industries, Inc.

14 pin surface mount:

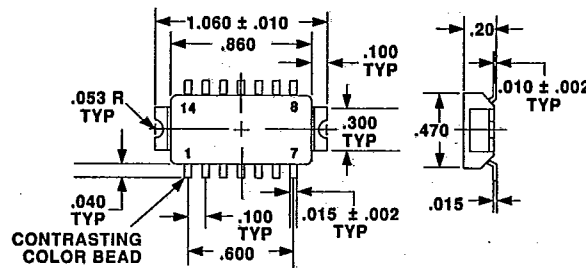

24 pin surface mount:

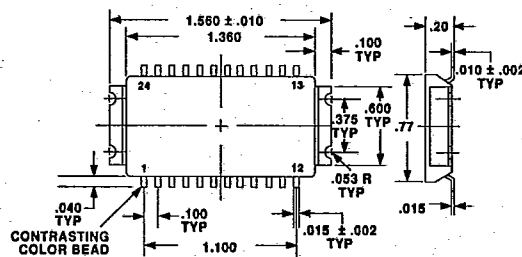

38 pin surface mount:

