

1.0 Features

- Primary-side feedback eliminates opto-isolators and simplifies design
- Direct drive of BJT switching device
- Multi-mode operation for highest overall efficiency
- Built-in cable drop compensation
- Very tight output voltage regulation
- No external compensation components required
- Complies with CEC/EPA no load power consumption and average efficiency regulations
- Built-in output constant-current control with primary-side feedback
- Low start-up current (10 μ A typical)
- Built-in soft start
- Built-in short circuit protection and output overvoltage protection
- Optional AC line under/overvoltage protection
- Fixed switching frequency: 45 kHz, 65 kHz or 75 kHz
- Dynamic base current control
- PFM operation at light load
- Built-in current sense resistor short protection

2.0 Description

The iW1690 is a high performance AC/DC power supply controller which uses digital control technology to build peak current mode PWM flyback power supplies. The device directly drives a BJT switching device and provides high efficiency along with a number of key built-in protection features while minimizing the external component count, simplifying EMI design and lowering the total bill of material cost. The iW1690 removes the need for secondary feedback circuitry while achieving excellent line and load regulation. It also eliminates the need for loop compensation components while maintaining stability over all operating conditions. Pulse-by-pulse waveform analysis allows for a loop response that is much faster than traditional solutions, resulting in improved dynamic load response. The built-in power limit function enables optimized transformer design in universal off-line applications and allows for a wide input voltage range.

The ultra-low start-up power and operating current at light load ensure that the iW1690 is ideal for applications targeting the newest regulatory standards for average efficiency and standby power.

3.0 Applications

- Low power AC/DC adapter/chargers for cell phones, PDAs, digital still cameras
- Low power AC/DC adapter/chargers to replace RCC implementations

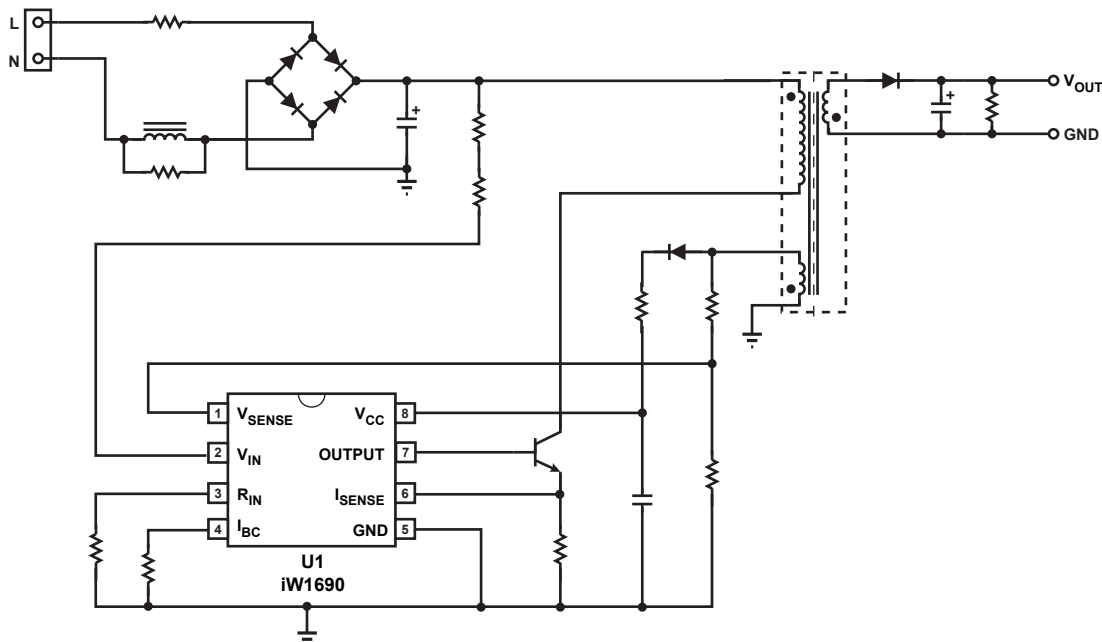
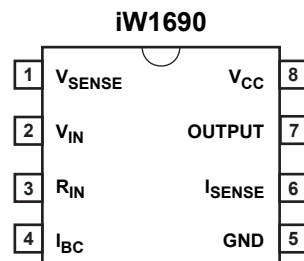

Figure 2.0.1 iW1690 Typical Application Circuit

4.0 Pinout Description



Pin #	Name	Type	Pin Description
1	V _{SENSE}	Analog Input	Auxiliary voltage sense (used for primary regulation and ZVS).
2	V _{IN}	Analog Input	Rectified AC line voltage sense.
3	R _{IN}	Analog Input	Sense line input voltage.
4	I _{BC}	Analog Input	Adjust maximum base current.
5	GND	Ground	Ground.
6	I _{SENSE}	Analog Input	Primary current sense. Used for cycle-by-cycle peak current control and limit.
7	OUTPUT	Output	Base drive for BJT.
8	V _{CC}	Power Input	Power supply for control logic and voltage sense for power-on reset circuitry.

5.0 Absolute Maximum Ratings

Absolute maximum ratings are the parameteic values or ranges which can cause permanent damage if exceeded. For maximum safe operating conditions, refer to Electrical Characteristics in Section 6.0.

Parameter	Symbol	Value	Units
DC supply voltage range (pin 8, $I_{CC} = 20\text{mA max}$)	V_{CC}	-0.3 to 18	V
Continuous DC supply current at V_{CC} pin	I_{CC}	20	mA
Peak DC supply current at V_{CC} pin	I_{CCPK}	120	mA
Low voltage output (pin 7)		-0.3 to 4.0	V
V_{SENSE} input (pin 1)		-0.6 to 4.0	V
V_{IN} input (pin 2)		-0.3 to 18.0	V
Low voltage analog input (pins 3, 4 and 6)		-0.3 to 4.0	V
Power dissipation at $T_A \leq 25^\circ\text{C}$	P_D	526	mW
Maximum junction temperature	T_{JMAX}	125	$^\circ\text{C}$
Storage temperature	T_{STG}	-65 to 150	$^\circ\text{C}$
Lead temperature during IR reflow for ≤ 15 seconds	T_{LEAD}	260	$^\circ\text{C}$
Thermal Resistance Junction-to-Ambient	θ_{JA}	160	$^\circ\text{C/W}$
ESD rating per JEDEC JESD22-A114 (HBM)		2,000	V
Latch-Up test per JEDEC 78		± 100	mA

6.0 Electrical Characteristics

$V_{CC} = 12\text{ V}$, $-40^\circ\text{C} \leq T_A \leq 85^\circ\text{C}$, unless otherwise specified (Note 1)

Parameter	Symbol	Test Conditions	Min	Typ	Max	Unit
V_{IN} SECTION (Pin 2)						
Start-up voltage low threshold	$V_{INST(LO)}$	$T_A = 25^\circ\text{C}$, positive edge	332	370	407	mV
Start-up voltage high threshold	$V_{INST(HI)}$	$T_A = 25^\circ\text{C}$, positive edge	1.755	1.950	2.145	V
Start-up current	$I_{IN(ST)}$	$V_{CC} = 10\text{ V}$		8	15	μA
Shutdown low voltage threshold	V_{UVDC}	$T_A = 25^\circ\text{C}$, negative edge	203	225	248	mV
Shutdown high voltage threshold	V_{OVDC}	$T_A = 25^\circ\text{C}$, positive edge	1.791	1.990	2.189	V
V_{SENSE} SECTION (Pin 1)						
Input leakage current	I_{VSENSE}	$V_{SENSE} = 2\text{ V}$			1	μA
Nominal voltage threshold	$V_{SENSE(NOM)}$	$T_A = 25^\circ\text{C}$, negative edge	1.522	1.538	1.553	V
Output OVP threshold	$V_{SENSE(MAX)}$	$T_A = 25^\circ\text{C}$, negative edge	1.667	1.700	1.734	V

6.0 Electrical Characteristics

$V_{CC} = 12\text{ V}$, $-40^{\circ}\text{C} \leq T_A \leq 85^{\circ}\text{C}$, unless otherwise specified (Note 1)

Parameter	Symbol	Test Conditions	Min	Typ	Max	Unit
OUTPUT SECTION (Pin 7)						
Output low level ON-resistance	$R_{DS(ON)LO}$	$I_{SINK} = 5\text{ mA}$		3	6.0	Ω
Output switching frequency	f_s	-02/-03/-08/-09 Suffixes $P_{LOAD} > 15\%$ of maximum		45		kHz
		-00/-05 Suffixes $P_{LOAD} > 15\%$ of maximum		65		kHz
I_{SENSE} SECTION (Pin 6)						
Overcurrent limit threshold	V_{OCP}			1.2		V
CC limit threshold	V_{CC-TH}				1.1	V
Input leakage current	I_{ISENSE}	$I_{SENSE} = 1\text{ V}$		1.6	2.5	μA
R_{IN} SECTION (Pin 3)						
Input leakage current	I_{RIN}	$R_{IN} = 1\text{ V}$			10	μA
I_{BC} SECTION (Pin 4)						
I_{BC} pin voltage	V_{IBC}	$R_{BC} = 100\text{ k}\Omega$		1		V
V_{CC} SECTION (Pin 8)						
Maximum operating voltage	$V_{CC(MAX)}$				16	V
Start-up threshold	$V_{CC(ST)}$	V_{CC} rising	11	12	13.2	V
Undervoltage lockout threshold	$V_{CC(UVL)}$	V_{CC} falling	5.0	5.5	6.1	V
Quiescent current	I_{CCQ}	$R_{BC} = 100\text{ k}\Omega$, no I_B current		2.5	6.0	mA

Notes:

Note 1. Adjust V_{CC} above the start-up threshold before setting at 12 V.

Note 2. These parameters are not 100% tested, guaranteed by design and characterization.

7.0 Typical Performance Characteristics

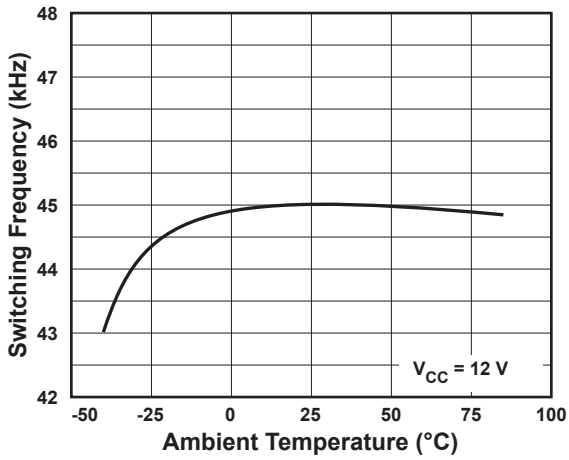

Figure 7.0.1 Switching Frequency vs. Temperature
-01/-02/-03/-08 Suffixes

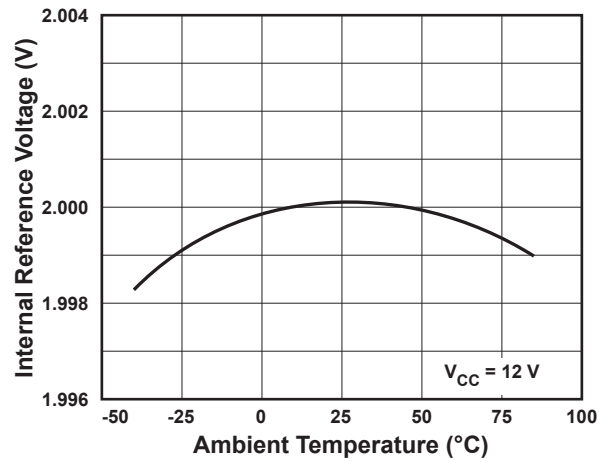

Figure 7.0.4 Internal Reference vs. Temperature

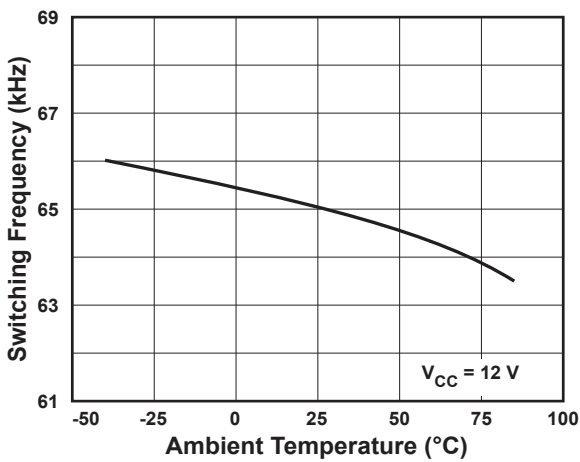

Figure 7.0.2 Switching Frequency vs. Temperature
-00/-05 Suffixes

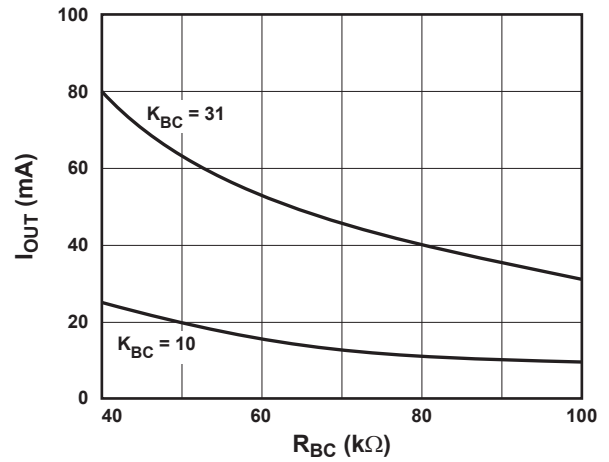

Figure 7.0.5 I_{OUT} vs. R_{BC}

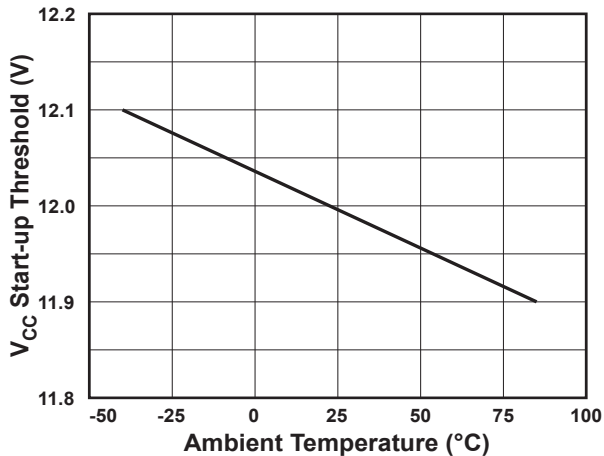

Figure 7.0.3 Start-Up vs. Temperature

9.1 Pin Detail

Pin 1 – V_{SENSE}

Sense signal input from auxiliary winding. This provides the secondary voltage feedback used for output regulation.

Pin 2 – V_{IN}

Sense signal input representing the rectified line voltage. V_{IN} is used for line regulation. The input line voltage is scaled using a resistor network. It also provides input undervoltage and overvoltage protection. This pin also provides the supply current to the IC during start-up.

Pin 3 – R_{IN}

Sense line input voltage. Connect this pin to GND with the R_{IN} resistor.

Pin 4 – I_{BC}

Adjusts the maximum base current for the BJT drive.

Pin 5 – GND

Ground.

Pin 6 – I_{SENSE}

Primary current sense. Used for cycle-cycle peak current control limit.

Pin 7 – OUTPUT

Base drive for the external power BJT switch.

Pin 8 – V_{CC}

Power supply for the controller during normal operation. The controller will start up when V_{CC} reaches 12 V (typical) and will shut-down when the V_{CC} voltage is 5.5 V (typical). A decoupling capacitor should be connected between the V_{CC} pin and GND.

9.2 Start-up

Prior to start-up the V_{IN} pin charges up the V_{CC} capacitor through the diode between V_{IN} and V_{CC} .

When V_{CC} is fully charged to a voltage higher than the start-up threshold $V_{CC(ST)}$, the ENABLE signal becomes active to enable the control logic, the ENABLE switch turns on, and the analog-to-digital converter begins to sense the input voltage. Once the voltage on the V_{IN} pin is above $V_{INST(LO)}$ but below $V_{INST(HI)}$, the iW1690 commences soft start function. An adaptive soft-start control algorithm is applied at startup state, during which the initial output pulses will be small and gradually get larger until the full pulse width is achieved. The peak current is limited cycle by cycle by I_{peak} comparator.

If at any time the V_{CC} voltage drops below $V_{CC(UVL)}$ threshold then all the digital logic is fully reset. At this time ENABLE switches off so that the V_{CC} capacitor can be charged up again towards the start-up threshold.

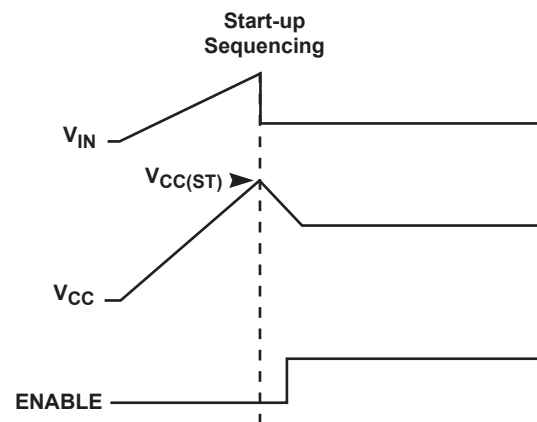

Figure 9.2.1 Start-up Sequencing Diagram

9.3 Understanding Primary Feedback

Figure 9.3.1 illustrates a simplified flyback converter. When the switch Q1 conducts during $t_{ON}(t)$, the current $i_g(t)$ is directly drawn from rectified sinusoid $v_g(t)$. The energy $E_g(t)$ is stored in the magnetizing inductance L_M . The rectifying diode D1 is reverse biased and the load current I_o is supplied by the secondary capacitor C_o . When Q1 turns off, D1 conducts and the stored energy $E_g(t)$ is delivered to the output.

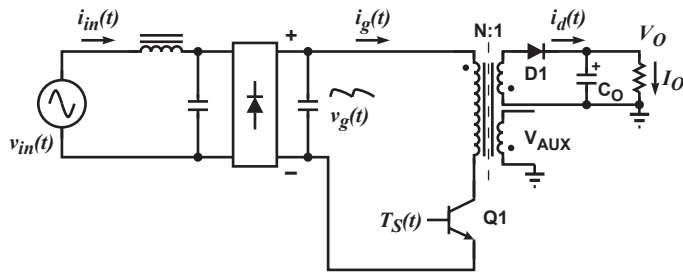

Figure 9.3.1 Simplified Flyback Converter

In order to tightly regulate the output voltage, the information about the output voltage and load current needs to be accurately sensed. In the DCM flyback converter, this information can be read via the auxiliary winding or the primary magnetizing inductance (L_M). During the Q_1 on-time, the load current is supplied from the output filter capacitor C_O . The voltage across L_M is $v_g(t)$, assuming the voltage dropped across Q_1 is zero. The current in Q_1 ramps up linearly at a rate of:

$$\frac{di_g(t)}{dt} = \frac{v_g(t)}{L_M} \quad (9.1)$$

At the end of on-time, the current has ramped up to:

$$i_{g_peak}(t) = \frac{v_g(t) \times t_{ON}}{L_M} \quad (9.2)$$

This current represents a stored energy of:

$$E_g = \frac{L_M}{2} \times i_{g_peak}(t)^2 \quad (9.3)$$

When Q_1 turns off at t_O , $i_g(t)$ in L_M forces a reversal of polarities on all windings. Ignoring the commutation-time caused by the leakage inductance L_K at the instant of turn-off t_O , the primary current transfers to the secondary at a peak amplitude of:

$$i_d(t) = \frac{N_P}{N_S} \times i_{g_peak}(t) \quad (9.4)$$

Assuming the secondary winding is master, the auxiliary winding is slave.

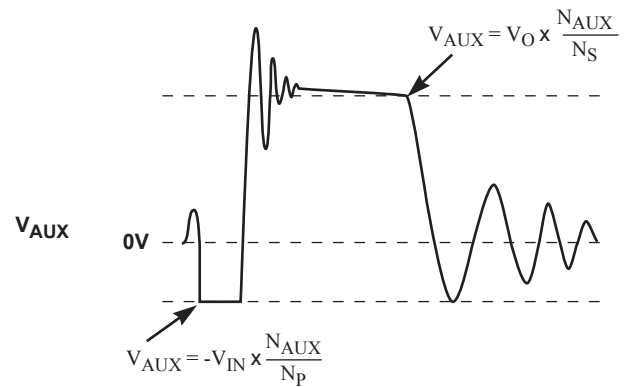

Figure 9.3.2 Auxiliary Voltage Waveforms

The auxiliary voltage is given by:

$$V_{AUX} = \frac{N_{AUX}}{N_S} (V_O + \Delta V) \quad (9.5)$$

and reflects the output voltage as shown in Figure 9.3.2.

The voltage at the load differs from the secondary voltage by a diode drop and IR losses. The diode drop is a function of current, as are IR losses. Thus, if the secondary voltage is always read at a constant secondary current, the difference between the output voltage and the secondary voltage will be a fixed ΔV . Furthermore, if the voltage can be read when the secondary current is small, ΔV will also be small. With the iW1690, ΔV can be ignored.

The real-time waveform analyzer in the iW1690 reads this information cycle by cycle. The part then generates a feedback voltage V_{FB} . The V_{FB} signal precisely represents the output voltage under most conditions and is used to regulate the output voltage.

9.4 Constant Voltage Operation

After soft-start has been completed, the digital control block measures the output conditions. It determines output power levels and adjusts the control system to a light load or a heavy load. If this is in the normal range, the device operates in the Constant Voltage (CV) mode, and changes the pulse width (T_{on}), and off time (T_{off}) in order to meet the output voltage regulation requirements. During this mode the PWM switching frequency is either 45 kHz or 65kHz, depending on which product option is being used.

If no voltage is detected on V_{SENSE} it is assumed that the auxiliary winding of the transformer is either open or shorted and the iW1690 shuts down.

9.5 Constant Current Operation

The constant current mode (CC mode) is useful in battery charging applications. During this mode of operation the iW1690 will regulate the output current at a constant maximum level regardless of the output voltage drop, while avoiding continuous conduction mode.

To achieve this regulation the iW1690 senses the load current indirectly through the primary current. The primary current is detected by the I_{SENSE} pin through a resistor from the BJT emitter to ground.

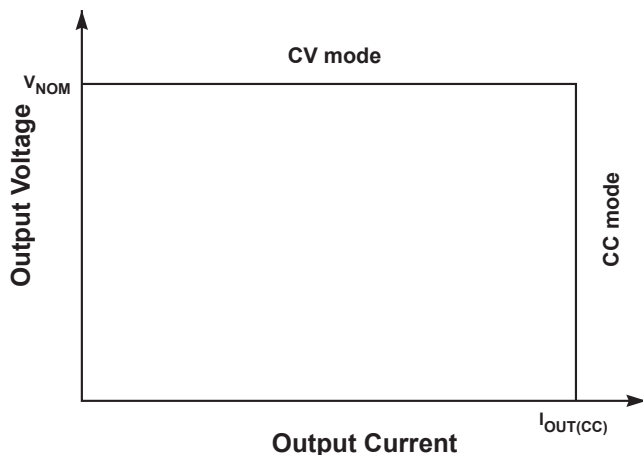

Figure 9.6.1 Power Envelope

9.6 PFM Mode at Light Load

The iW1690 normally operates in a fixed frequency PWM mode when I_{OUT} is greater than approximately 10% of the specified maximum load current. As the output load I_{OUT} is reduced, the on-time t_{ON} is decreased. At the moment that the load current drops below 10% of nominal, the controller transitions to Pulse Frequency Modulation (PFM) mode. Thereafter, the on-time will be modulated by the line voltage and the off-time is modulated by the load current. The device automatically returns to PWM mode when the load current increases.

9.7 Variable Frequency Operation

At each of the switching cycles, the falling edge of V_{SENSE} will be checked. If the falling edge of V_{SENSE} is not detected, the off-time will be extended until the falling edge of V_{SENSE} is detected. The maximum switching period is seen at 75 μ s. When the switching period reaches 75 μ s, the iW1690 immediately shuts off. This avoids operating at continuous conduction mode.

9.8 Internal Loop Compensation

The iW1690 incorporates an internal Digital Error Amplifier with no requirement for external loop compensation. For a typical power supply design, the loop stability is guaranteed to provide at least 45 degrees of phase margin and -20dB of gain margin.

9.9 Voltage Protection Functions

The iW1690 includes functions that protect against input line undervoltage and overvoltage (UV/OV) and the output overvoltage (OVP).

The input voltage is monitored by the V_{IN} pin and the output voltage is monitored by the V_{SENSE} pin. If the voltage at these pins exceed their undervoltage or overvoltage thresholds the iW1690 shuts down immediately. However, the IC remains biased which discharges the V_{CC} supply. Once V_{CC} drops below the UVLO threshold, the controller resets itself and then initiates a new soft-start cycle. The controller continues attempting start-up until the fault condition is removed.

9.10 PCL, OC and SRS Protection

Peak-current limit (PCL), over-current protection (OCP) and sense-resistor short protection (SRSP) are features built-in to the iW1690. With the I_{SENSE} pin the iW1690 is able to monitor the primary peak current. This allows for cycle by cycle peak current control and limit. When the primary peak current multiplied by the I_{SENSE} sense resistor is greater than 1.2 V an over current (OCP) is detected and the IC will immediately turn off the base drive until the next cycle. The OCP is not a latched shutdown. The base drive will send out switching pulse in the next cycle, and the switching pulse will continue if the OCP threshold is not reached; or, the switching pulse will shut down again if the OCP threshold is still reached.

If the I_{SENSE} sense resistor is shorted there is a potential danger of the over current condition not being detected. Thus the IC is designed to detect this sense-resistor-short fault after the start up, and shutdown immediately. Similar to the OVP shutdown, the V_{CC} will be discharged since the IC remains biased. Once V_{CC} drops below the UVLO threshold, the controller resets itself and then initiates a new soft-start cycle. The controller continues attempting start-up, but does not fully start-up until the fault condition is removed.

9.11 Cable Drop Compensation

The iW1690 incorporates an innovative method to compensate for any IR drop in the secondary circuitry including cable and cable connector. A 5 W AC adapter with 5 V DC output has 6% deviation at 1 A load current due to the drop across the DC cable without cable compensation. The iW1690 cancels this error by providing a voltage offset to the feedback signal based on the amount of load current detected.

To calculate the amount of cable compensation needed, take the resistance of the cable and connector and multiply by the maximum output current.

9.12 Dynamic Base Current Control

One important feature of the iW1690 is that it directly drives a BJT switching device with dynamic base current control to optimize performance. The reference BJT base current is adjusted by connecting an external R_{BC} resistor from I_{BC} to GND, which generates a constant current source with a value of:

$$I_{BC_REF} = \frac{1V}{R_{BC}} \quad (9.6)$$

I_{BC_REF} is multiplied by 100 times inside the IC and is then used to control the base current for the BJT drive, I_{B_OUT} , which is the output I_B current at the OUTPUT pin. The I_{B_OUT} is dynamically controlled according to the power supply load change, as:

$$I_{B_OUT} = I_{BC_REF} \times 100 \times K_{BC} \quad (9.7)$$

Where K_{BC} is dynamically changed by the digital control block: the heavier the load is, the higher K_{BC} becomes. The minimum K_{BC} is limited to 10, and the maximum K_{BC} is limited to 31. Therefore, the maximum I_{B_OUT} is set by $(1V/R_{BC}) \times 100 \times 31$. The range of R_{BC} is 40 k Ω to 100 k Ω . Choosing different R_{BC} can adjust the maximum I_{B_OUT} for different BJT's and/or different power levels. The minimum and maximum I_{B_OUT} are given by table 9.12.1.

	K_{BC}	$R_{BC} = 40 \text{ k}\Omega$		$R_{BC} = 100 \text{ k}\Omega$		Units
		I_{BC_REF}	I_{B_OUT}	I_{BC_REF}	I_{B_OUT}	
Minimum	10	0.025	25	0.01	10	mA
Maximum	31	0.025	77.5	0.01	31	mA

Table 9.12.1

10.0 Physical Dimensions

8-Lead Small Outline (SOIC) Package

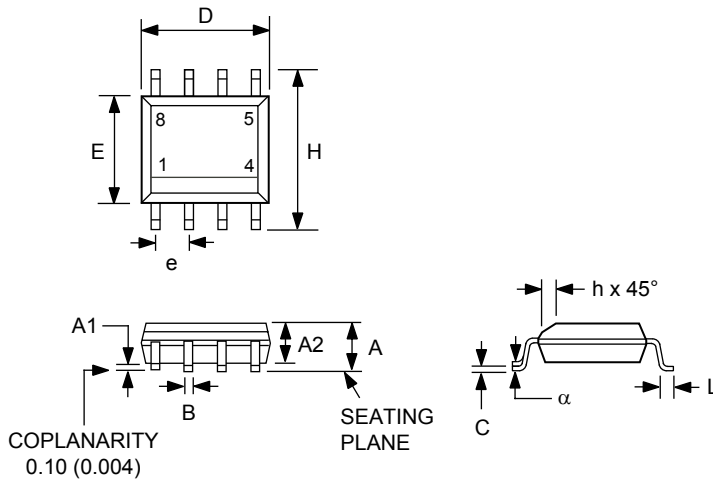

Symbol	Inches		Millimeters	
	MIN	MAX	MIN	MAX
A	0.053	0.069	1.35	1.75
A1	0.0040	0.010	0.10	0.25
A2	0.049	0.059	1.25	1.50
B	0.014	0.019	0.35	0.49
C	0.007	0.010	0.19	0.25
D	0.189	0.197	4.80	5.00
E	0.150	0.157	3.80	4.00
e	0.050 BSC		1.27 BSC	
H	0.228	0.244	5.80	6.20
h	0.10	0.020	0.25	0.50
L	0.016	0.049	0.4	1.25
α	0°	8°		

Figure 10.0.1. Physical dimensions, 8-lead SOIC package

Compliant to JEDEC Standard MS12F

Controlling dimensions are in inches; millimeter dimensions are for reference only

This product is RoHS compliant and Halide free.

Soldering Temperature Resistance:

[a] Package is IPC/JEDEC Std 020D Moisture Sensitivity Level 1

[b] Package exceeds JEDEC Std No. 22-A111 for Solder Immersion Resistance; package can withstand 10 s immersion < 270°C

Dimension D does not include mold flash, protrusions or gate burrs. Mold flash, protrusions or gate burrs shall not exceed 0.15 mm per end. Dimension E1 does not include interlead flash or protrusion. Interlead flash or protrusion shall not exceed 0.25 mm per side. D and E1 dimensions are determined at datum H.

The package top may be smaller than the package bottom. Dimensions D and E1 are determined at the outermost extremes of the plastic body exclusive of mold flash, tie bar burrs, gate burrs and interlead flash, but including any mismatch between the top and bottom of the plastic body.

iW1690

Low-Power Off-line Digital PWM Controller



11.0 Ordering Information

Part Number	Options	Package	Description
iW1690-00	$f_{sw} = 65$ kHz, Cable Comp = 0 mV	SOIC-8	Tape & Reel ²
iW1690-02	$f_{sw} = 45$ kHz, Cable Comp = 150 mV, No OVDC ¹	SOIC-8	Tape & Reel ²
iW1690-03	$f_{sw} = 45$ kHz, Cable Comp = 412 mV, No OVDC ¹	SOIC-8	Tape & Reel ²
iW1690-05	$f_{sw} = 65$ kHz, Cable Comp = 337 mV	SOIC-8	Tape & Reel ²
iW1690-07	$f_{sw} = 75$ kHz, Cable Comp = 0 mV	SOIC-8	Tape & Reel ²
iW1690-08	$f_{sw} = 45$ kHz, Cable Comp = 337 mV	SOIC-8	Tape & Reel ²
iW1690-09	$f_{sw} = 45$ kHz, Cable Comp = 0 mV, No OVDC ¹	SOIC-8	Tape & Reel ²

Note 1: No input over-voltage shutdown.

Note 2: Product is provided on 13" reels, 2,500 per reel. Minimum ordering quantity is 2,500. This product is RoHS compliant and Halide free.

iW1690

Low-Power Off-line Digital PWM Controller



About iWatt

iWatt Inc. is a fabless semiconductor company that develops intelligent power management ICs for computer, communication, and consumer markets. The company's patented *pulseTrain*™ technology, the industry's first truly digital approach to power system regulation, is revolutionizing power supply design.

Trademark Information

© 2008 iWatt, Inc. All rights reserved. iWatt, the iW light bulb, and *pulseTrain* are trademarks of iWatt, Inc. All other trademarks and registered trademarks are the property of their respective companies.

Contact Information

Web: <http://www.iwatt.com>

E-mail: info@iwatt.com

Phone: 408-374-4200

Fax: 408-341-0455

iWatt Inc.

101 Albright Way

Los Gatos CA 95032-1827

Disclaimer

iWatt reserves the right to make changes to its products and to discontinue products without notice. The applications information, schematic diagrams, and other reference information included herein is provided as a design aid only and are therefore provided as-is. iWatt makes no warranties with respect to this information and disclaims any implied warranties of merchantability or non-infringement of third-party intellectual property rights.

Certain applications using semiconductor products may involve potential risks of death, personal injury, or severe property or environmental damage ("Critical Applications").

IWATT SEMICONDUCTOR PRODUCTS ARE NOT DESIGNED, INTENDED, AUTHORIZED, OR WARRANTED TO BE SUITABLE FOR USE IN LIFE-SUPPORT APPLICATIONS, DEVICES OR SYSTEMS, OR OTHER CRITICAL APPLICATIONS.

Inclusion of iWatt products in critical applications is understood to be fully at the risk of the customer. Questions concerning potential risk applications should be directed to iWatt, Inc.

iWatt semiconductors are typically used in power supplies in which high voltages are present during operation. High-voltage safety precautions should be observed in design and operation to minimize the chance of injury.