

MURATA type DE- KX, KH & KY

A range of radial lead Y1 and Y2 class capacitors, with extensive approvals, designed for mains interference suppression. Meets IEC384-14 2nd edition and suitable for X1, across the line, applications. Coated with flame retardant epoxy resin. An option of loose or taped and boxed product is provided throughout.

DISC CERAMIC

NEW

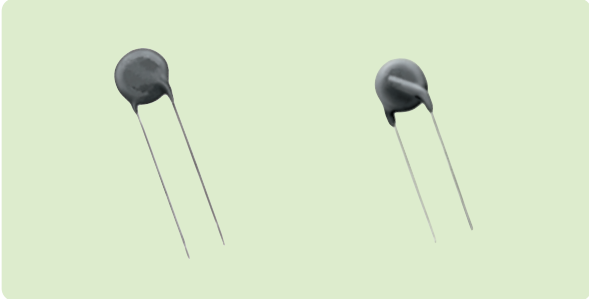

- ◆ Mains rated Y1/X1 & Y2/X1 class
- ◆ Meet IEC384-14 2nd ed.
- ◆ Flame retardant coating to UL94V-0
- ◆ Option of loose or taped & boxed
- ◆ Body colour **Blue**

Specification

Meets IEC384-14 2nd edition	
Voltage rating	250Vac
Capacitance tolerance	B ±10% E, F ±20%
Temperature coefficient	B ±10% over -25°C to +85°C E +20%, -55% over -25°C to +85°C F +30%, -80% over -25°C to +85°C
Test voltage	KX 4000Vac KH 2600Vac KY 2000Vac (5mm pitch) 2600Vac (7.5mm pitch)
Operating temperature range	-25°C to +85°C

Dimensions (mm)

LOOSE

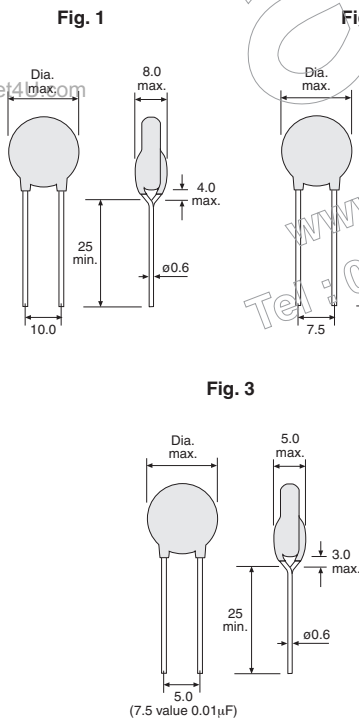

Packaging

TAPED & BOXED

Fig. 4

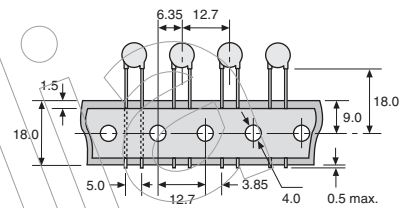

Fig. 5

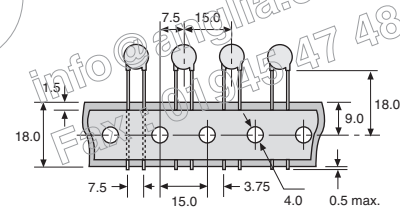

Fig. 6

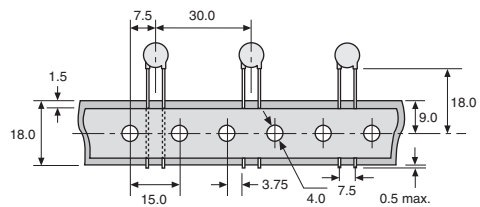
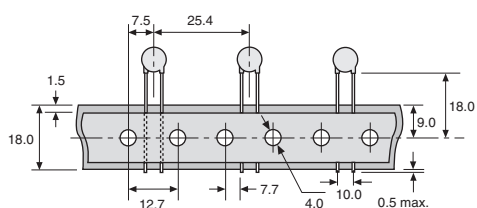

Fig. 7



Y1/X1Class MURATA type DE- KX



Value (pF)	(μF)	Dielectric	Tolerance	Dimensions (mm)		Fig.
				Dia. max.	Pitch	
100	0.0001	B	10%	9	10	1
150	0.00015	B	10%	9	10	1
220	0.00022	B	10%	9	10	1
330	0.00033	B	10%	9	10	1
470	0.00047	B	10%	9	10	1
680	0.00068	B	10%	10	10	1
1000	0.001	E	20%	8	10	1
1500	0.0015	E	20%	9	10	1
2200	0.0022	E	20%	10	10	1
3300	0.0033	E	20%	12	10	1
3900	0.0039	E	20%	13	10	1
4700	0.0047	E	20%	15	10	1

Manf. Part No. & anglia Order Code Loose	Fig.
DE1B3KX101KA5B	1 + 7
DE1B3KX151KA5B	1 + 7
DE1B3KX221KA5B	1 + 7
DE1B3KX331KA5B	1 + 7
DE1B3KX471KA5B	1 + 7
DE1B3KX681KA5B	1 + 7
DE1E3KX102MA5BA01	1 + 7
DE1E3KX152MA5BA01	1 + 7
DE1E3KX222MA5BA01	1 + 7
DE1E3KX332MA5BA01	1 + 7
DE1E3KX392MA5BA01	1 + 7
DE1E3KX472MA5BA01	1 + 7

Manf. Part No. & anglia Order Code Taped	Fig.
DE1B3KX101KN5A	1 + 7
DE1B3KX151KN5A	1 + 7
DE1B3KX221KN5A	1 + 7
DE1B3KX331KN5A	1 + 7
DE1B3KX471KN5A	1 + 7
DE1B3KX681KN5A	1 + 7
DE1E3KX102MN5AA01	1 + 7
DE1E3KX152MN5AA01	1 + 7
DE1E3KX222MN5AA01	1 + 7
DE1E3KX332MN5AA01	1 + 7
DE1E3KX392MN5AA01	1 + 7
DE1E3KX472MN5AA01	1 + 7

Y2/X1Class MURATA type DE- KH



Value (pF)	(μF)	Dielectric	Tolerance	Dimensions (mm)		Fig.
				Dia. max.	Pitch	
100	0.0001	B	10%	8	7.5	2
150	0.00015	B	10%	8	7.5	2
220	0.00022	B	10%	8	7.5	2
330	0.00033	B	10%	8	7.5	2
470	0.00047	B	10%	8	7.5	2
680	0.00068	B	10%	9	7.5	2
1000	0.001	E	20%	8	7.5	2
1500	0.0015	E	20%	9	7.5	2
2200	0.0022	E	20%	10	7.5	2
3300	0.0033	E	20%	12	7.5	2
4700	0.0047	E	20%	13	7.5	2
10000	0.01	F	20%	16	7.5	2

Manf. Part No. & anglia Order Code Loose	Fig.
DE2B3KH101KA3B	2 + 5
DE2B3KH151KA3B	2 + 5
DE2B3KH221KA3B	2 + 5
DE2B3KH331KA3B	2 + 5
DE2B3KH471KA3B	2 + 5
DE2B3KH681KA3B	2 + 5
DE2E3KH102MA3B	2 + 5
DE2E3KH152MA3B	2 + 5
DE2E3KH222MA3B	2 + 5
DE2E3KH332MA3B	2 + 5
DE2E3KH472MA3B	2 + 5
DE2F3KH103MA3B	2 + 6

Manf. Part No. & anglia Order Code Taped	Fig.
DE2B3KH101KN3A	2 + 5
DE2B3KH151KN3A	2 + 5
DE2B3KH221KN3A	2 + 5
DE2B3KH331KN3A	2 + 5
DE2B3KH471KN3A	2 + 5
DE2B3KH681KN3A	2 + 5
DE2E3KH102MN3A	2 + 5
DE2E3KH152MN3A	2 + 5
DE2E3KH222MN3A	2 + 5
DE2E3KH332MN3A	2 + 5
DE2E3KH472MN3A	2 + 5
DE2F3KH103MN7A	2 + 6

Y2/X1Class MURATA type DE- KY



Value (pF)	(μF)	Dielectric	Tolerance	Dimensions (mm)		Fig.
				Dia. max.	Pitch	
100	0.0001	B	10%	8	5	3
150	0.00015	B	10%	8	5	3
220	0.00022	B	10%	8	5	3
330	0.00033	B	10%	8	5	3
470	0.00047	B	10%	8	5	3
680	0.00068	B	10%	8	5	3
1000	0.001	E	20%	8	5	3
1500	0.0015	E	20%	8	5	3
2200	0.0022	E	20%	9	5	3
3300	0.0033	E	20%	10	5	3
4700	0.0047	E	20%	11	5	3
10000	0.01	F	20%	14	7.5	3

Manf. Part No. & anglia Order Code Loose	Fig.
DE2B3KY101KA2BM01	3 + 4
DE2B3KY151KA2BM01	3 + 4
DE2B3KY221KA2BM01	3 + 4
DE2B3KY331KA2BM01	3 + 4
DE2B3KY471KA2BM01	3 + 4
DE2B3KY681KA2BM01	3 + 4
DE2E3KY102MA2BM01	3 + 4
DE2E3KY152MA2BM01	3 + 4
DE2E3KY222MA2BM01	3 + 4
DE2E3KY332MA2BM01	3 + 4
DE2E3KY472MA2BM01	3 + 4
DE2F3KY103MA3B	3 + 6

Manf. Part No. & anglia Order Code Taped	Fig.
DE2B3KY101KN2AM01	3 + 4
DE2B3KY151KN2AM01	3 + 4
DE2B3KY221KN2AM01	3 + 4
DE2B3KY331KN2AM01	3 + 4
DE2B3KY471KN2AM01	3 + 4
DE2B3KY681KN2AM01	3 + 4
DE2E3KY102MN2AM01	3 + 4
DE2E3KY152MN2AM01	3 + 4
DE2E3KY222MN2AM01	3 + 4
DE2E3KY332MN2AM01	3 + 4
DE2E3KY472MN2AM01	3 + 4
DE2F3KY103MN7A	3 + 6

muRata

For the very latest information and news on the full range of Murata products available from Anglia, visit our website : www.anglia.com/murata

Alternatively, contact our Sales Desk to discuss your specific requirements.

JNC Disc Ceramic Suppression Capacitors shown overleaf > > >

JYA-NAY type JY

A range of radial lead Y2 class capacitors, with extensive approvals, designed for mains interference suppression. Meets EN132400 (IEC384-14 2nd edition), the unified European safety standard. Rated 400Vac and suitable for X1, across the line, applications. Coated with flame retardant epoxy resin.

DISC CERAMIC

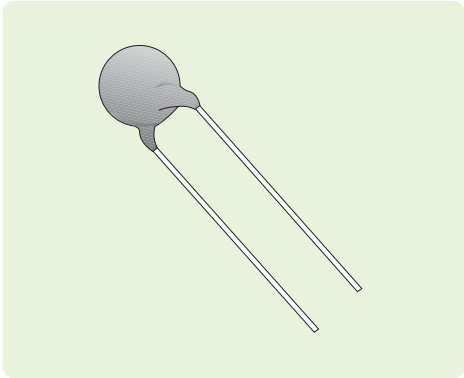

- ◆ Mains rated **Y2/X1** class
- ◆ Meets the unified European safety standard EN132400
- ◆ 400Vac rating
- ◆ Flame retardant coating to UL94V-0
- ◆ Body colour **Blue**

Specification

Meets EN132400 (IEC384-14 2nd edition)

Voltage rating	400Vac
Capacitance tolerance	±10%(Y5P), ±20%(Y5V)
Temperature coefficient	±10%(Y5P), +30 to -80%(Y5V) over -25°C to +85°C
Test voltage	2600Vac for 60 seconds
Operating temperature range	-25°C to +85°C
Insulation resistance	≥10,000MΩ
Dissipation factor	≤2.5%(Y5P), ≤5%(Y5V) at 1kHz

Dimensions (mm)

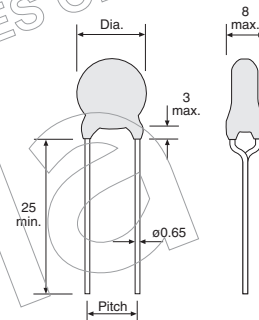

anglia.com
 info@anglia.com
 Fax: 01945 47 48 49

www.DataSheet4U.com

Y2/X1 Class JYA-NAY type JY



Value (pF)	(µF)	Tolerance	Dimensions (mm)		Manf. Part No.	anglia Order Code
			Dia. max.	Pitch		
Y5P dielectric						
100	0.0001	10%	8	7.5	JY08B101KY72	098420
150	0.00015	10%	8	7.5	JY08B151KY72	098421
220	0.00022	10%	8	7.5	JY08B221KY72	098422
330	0.00033	10%	8	7.5	JY08B331KY72	098423
470	0.00047	10%	8	7.5	JY08B471KY72	098424
560	0.00056	10%	9	7.5	JY09B561KY72	098425
680	0.00068	10%	9	7.5	JY09B681KY72	098426
1000	0.001	10%	10	7.5	JY10B102KY72	098427
Y5V dielectric						
1000	0.001	20%	8	7.5	JY08F102MY72	098430
1500	0.0015	20%	9	7.5	JY09F152MY72	098431
2200	0.0022	20%	9	7.5	JY09F222MY72	098432
3300	0.0033	20%	10	10	JY10F332MY02	098433
3900	0.0039	20%	11	10	JY11F392MY02	098434
4700	0.0047	20%	12	7.5	JY12F472MY72	098435
4700	0.0047	20%	12	10	JY12F472MY02	098436
10000	0.01	20%	16	10	JY16F103MY02	098437

TAPED PRODUCT (Boxed or Reeled) available to special order