

FUSES / SICHERUNGEN

SPT 5 × 20

Non resettable fuses / Nicht rückstellende Sicherungen

Miniature Fuses Type SPT 5 × 20

time-lag T
high breaking capacity H
Ceramic tube



Geräteschutzsicherungen Typ SPT 5 × 20

träge T
grosses Ausschaltvermögen H
Keramicrohr

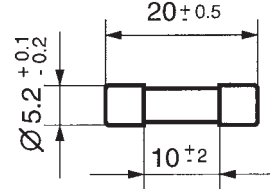

Standards / Normen

IEC 60127-2/5, EN 60127-2/5.

Approvals / Approbationen

- SEV UL VDE to / bis 6,3 A
- VDE CSA VDE 8 A + 10 A
- SEMKO

Pre-arcing time/current characteristic (at T_a 23 °C)

Zeit-Strom-Charakteristik (bei T_a 23 °C)

n · I _n Rated current I _n / Nennstrom I _n	1,5 · I _n		2,1 · I _n		2,75 · I _n		4 · I _n		10 · I _n	
	min.	max.	min.	max.	min.	max.	min.	max.	min.	max.
500 mA – 800 mA	60 min	30 min	250 ms	80 s	50 ms	5 s	5 ms	150 ms		
1 A – 3,15 A	60 min	30 min	750 ms	80 s	95 ms	5 s	10 ms	150 ms		
4 A – 6,3 A	60 min	30 min	750 ms	80 s	150 ms	5 s	20 ms	150 ms		
8 A – 10 A	30 min	30 min	750 ms	80 s	150 ms	5 s	20 ms	150 ms		
12,5 A – 16 A	15 min	30 min	750 ms	80 s	150 ms	5 s	20 ms	150 ms		

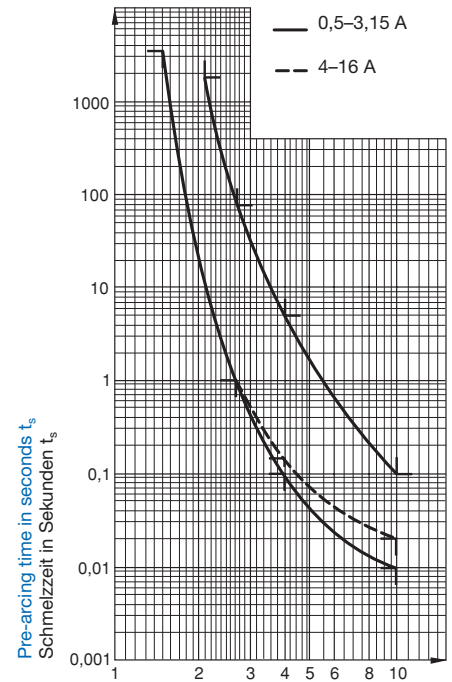

Multiple of rated current I_n
Vielfaches des Nennstromes I_n

Order No. / Bestell-Nr.	Rated current I _n / Rated voltage U _n / Nennstrom I _n / Nennspannung U _n	Breaking capacity / Ausschaltvermögen	Voltage drop / Spannungsfall at / bei I _n		Sustained power dissipation / Verlustleistung at / bei 1,5 I _n		Pre-arcing I ² t / Schmelz I ² t at / bei 10 · I _n	Approvals / Approbationen							
			max. IEC 60127 mV	typ. mV	max. IEC 60127 W	typ. W		typ. A ² s	SEV	VDE	SEMKO	UL	CSA		
0001.2501	500 mA / 250 V*	IEC: H = 1500 A / 250 V AC, p.f. / cos φ 0,7-0,8 UL: 10 000 A / 125 V AC, p.f. / cos φ 0,7-0,8 1500 A / 250 V AC p.f. / cos φ 0,7-0,8	850	360	1,6	0,5	5 · 10 ⁻¹								
0001.2502	630 mA / 250 V*		650	330	1,6	0,5		1,55							
0001.2503	800 mA / 250 V*		500	260	1,6	0,5		2,3							
0001.2504	1 A / 250 V		350	180	2,5	0,5		1,1	•	•	•	•	•	•	•
0001.2505	1,25 A / 250 V		300	150	2,5	0,5		1,86	•	•	•	•	•	•	•
0001.2506	1,6 A / 250 V		200	130	2,5	0,5		4,35	•	•	•	•	•	•	•
0001.2507	2 A / 250 V		190	120	2,5	0,6		9,2	•	•	•	•	•	•	•
0001.2508	2,5 A / 250 V		180	100	2,5	0,6		11,7	•	•	•	•	•	•	•
0001.2509	3,15 A / 250 V		140	100	4	0,8		33,7	•	•	•	•	•	•	•
0001.2510	4 A / 250 V		100	90	4	0,9		62,4	•	•	•	•	•	•	•
0001.2511	5 A / 250 V		100	90	4	1,2		97,5	•	•	•	•	•	•	•
0001.2512	6,3 A / 250 V		100	70	4	1,2		171	•	•	•	•	•	•	•
0001.2513	8 A / 250 V*		100	70	4	1,3		268	•	•	•	•	•	•	•
0001.2514	10 A / 250 V*		1000 A / 250 V AC p.f. / cos φ 1	100	70	4		2,1	400	•	•	•	•	•	•
0001.2515	12,5 A / 250 V*	UL:		70		3,1	563						•	•	
0001.2516	16 A / 250 V*	500 A / 125 V AC, p.f. / cos φ 0,7-0,8 1000 A / 125 V AC p.f. / cos φ 1 500 A / 250 V AC p.f. / cos φ 1		70		4,0	1500						•	•	

* Not mentioned in the standards / In den Normen nicht enthalten



Available as Pigtail miniature fuses, see page 100 /
Auch als G-Sicherungseinsätze mit Drahtanschlüssen lieferbar, siehe Seite 100

Miniature Fuses with Pigtails
Type SP 5 × 20

quick acting F
high breaking capacity

Geräteschutzsicherungen mit Drahtanschlüssen
Typ SP 5 × 20

flink F
grosses Ausschaltvermögen



Order No. / Bestell-Nr.		I _n / U _n
0001.1001.PT	0001.1001.TR	500 mA / 250 V
0001.1002.PT	0001.1002.TR	630 mA / 250 V
0001.1003.PT	0001.1003.TR	800 mA / 250 V
0001.1004.PT	0001.1004.TR	1 A / 250 V
0001.1005.PT	0001.1005.TR	1,25 A / 250 V
0001.1006.PT	0001.1006.TR	1,6 A / 250 V
0001.1007.PT	0001.1007.TR	2 A / 250 V
0001.1008.PT	0001.1008.TR	2,5 A / 250 V
0001.1009.PT	0001.1009.TR	3,15 A / 250 V
0001.1010.PT	0001.1010.TR	4 A / 250 V
0001.1011.PT	0001.1011.TR	5 A / 250 V
0001.1012.PT	0001.1012.TR	6,3 A / 250 V
0001.1013.PT	0001.1013.TR	8 A / 250 V
0001.1014.PT	0001.1014.TR	10 A / 250 V

Technical data see page 96 / Technische Daten siehe Seite 96

Miniature Fuses with Pigtails
Type SPT 5 × 20

time-lag T
high breaking capacity

Geräteschutzsicherungen mit Drahtanschlüssen
Typ SPT 5 × 20

träge T
grosses Ausschaltvermögen

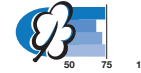

Order No. / Bestell-Nr.		I _n / U _n
0001.2504.PT	0001.2504.TR	1 A / 250 V
0001.2505.PT	0001.2505.TR	1,25 A / 250 V
0001.2506.PT	0001.2506.TR	1,6 A / 250 V
0001.2507.PT	0001.2507.TR	2 A / 250 V
0001.2508.PT	0001.2508.TR	2,5 A / 250 V
0001.2509.PT	0001.2509.TR	3,15 A / 250 V
0001.2510.PT	0001.2510.TR	4 A / 250 V
0001.2511.PT	0001.2511.TR	5 A / 250 V
0001.2512.PT	0001.2512.TR	6,3 A / 250 V
0001.2513.PT	0001.2513.TR	8 A / 250 V
0001.2514.PT	0001.2514.TR	10 A / 250 V

Technical data see page 97 / Technische Daten siehe Seite 97

Miniature Fuses with Pigtails
Type FSF 5 × 20

quick acting F
low breaking capacity

Geräteschutzsicherungen mit Drahtanschlüssen
Typ FSF 5 × 20

flink F
kleines Ausschaltvermögen

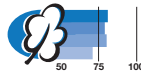

Order No. / Bestell-Nr.		I _n / U _n
0034.1513.PT	0034.1513.TR	500 mA / 250 V
0034.1514.PT	0034.1514.TR	630 mA / 250 V
0034.1515.PT	0034.1515.TR	800 mA / 250 V
0034.1516.PT	0034.1516.TR	1 A / 250 V
0034.1517.PT	0034.1517.TR	1,25 A / 250 V
0034.1518.PT	0034.1518.TR	1,6 A / 250 V
0034.1519.PT	0034.1519.TR	2 A / 250 V
0034.1520.PT	0034.1520.TR	2,5 A / 250 V
0034.1521.PT	0034.1521.TR	3,15 A / 250 V
0034.1522.PT	0034.1522.TR	4 A / 250 V
0034.1523.PT	0034.1523.TR	5 A / 250 V
0034.1524.PT	0034.1524.TR	6,3 A / 250 V
0034.1525.PT	0034.1525.TR	8 A / 250 V

Technical data see page 89 / Technische Daten siehe Seite 89

Miniature Fuses with Pigtails
Type FST 5 × 20

time-lag T
low breaking capacity

Geräteschutzsicherungen mit Drahtanschlüssen
Typ FST 5 × 20

träge T
kleines Ausschaltvermögen

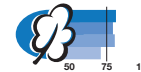

Order No. / Bestell-Nr.		I _n / U _n
0034.3104.PT	0034.3104.TR	50 mA / 250 V
0034.3105.PT	0034.3105.TR	63 mA / 250 V
0034.3106.PT	0034.3106.TR	80 mA / 250 V
0034.3107.PT	0034.3107.TR	100 mA / 250 V
0034.3108.PT	0034.3108.TR	125 mA / 250 V
0034.3109.PT	0034.3109.TR	160 mA / 250 V
0034.3110.PT	0034.3110.TR	200 mA / 250 V
0034.3111.PT	0034.3111.TR	250 mA / 250 V
0034.3112.PT	0034.3112.TR	315 mA / 250 V
0034.3113.PT	0034.3113.TR	400 mA / 250 V
0034.3114.PT	0034.3114.TR	500 mA / 250 V
0034.3115.PT	0034.3115.TR	630 mA / 250 V
0034.3116.PT	0034.3116.TR	800 mA / 250 V
0034.3117.PT	0034.3117.TR	1 A / 250 V
0034.3118.PT	0034.3118.TR	1,25 A / 250 V
0034.3165.PT	0034.3165.TR	1,4 A / 250 V
0034.3119.PT	0034.3119.TR	1,6 A / 250 V
0034.3120.PT	0034.3120.TR	2 A / 250 V
0034.3121.PT	0034.3121.TR	2,5 A / 250 V
0034.3122.PT	0034.3122.TR	3,15 A / 250 V
0034.3123.PT	0034.3123.TR	4 A / 250 V
0034.3124.PT	0034.3124.TR	5 A / 250 V
0034.3125.PT	0034.3125.TR	6,3 A / 250 V
0034.3126.PT	0034.3126.TR	8 A / 250 V

Technical data see page 90 / Technische Daten siehe Seite 90

Packaging / Verpackung:

00XX.XXXX.PT Boxes of 1000 pieces / lose à 1000 Stück
00XX.XXXX.TR Taped and reeled / gegurtet à 1000 Stück

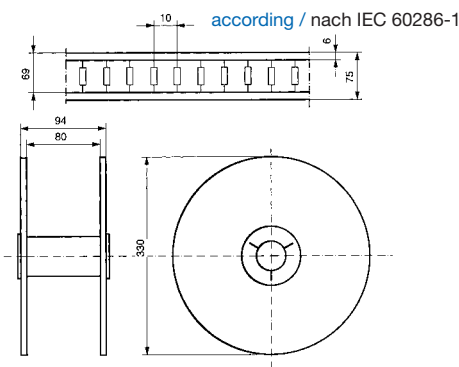

Dimensions / Abmessungen

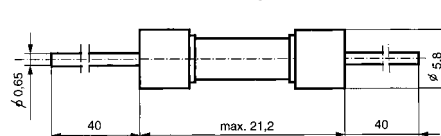

Pigtail only approved up to 8 A / Pigtail nur bis und mit 8 A
approbiert