

ADVANCED INFORMATION

STEP-DOWN CONVERTER WITH BATTERY MONITOR

FEATURES

- Minimum External Component Count (1 coil, 1 cap)
- Miniature 6 Pin SOT23L-6 Surface Mount Package
- Up To 95% Efficient
- Extremely Low Operating Current (24 μ A)
- Low Quiescent Current (18 μ A)
- Low Ripple
- Fast Transient Response
- Linear Dropout Characteristics
- Short Circuit Protection
- Regulates Down to 1.8 V
- Synchronous Rectification
- Internal Battery Monitor

DESCRIPTION

The TK654xx low power step-down converter is designed for portable battery systems, capable of operating from a single Li-ion battery cell or multiple alkaline or rechargeable (NiCd or NiMH) battery cells (up to 6 V). The TK654xx provides the power switch, synchronous rectifier, and the control circuit for a buck step-down converter. Only two external components are required to complete the step-down conversion.

The TK654xx provides laser-trimmed output voltages ranging from 1.8 V to 3.3 V. The low resistance MOSFET switch and synchronous rectifier allow average currents up to 200 mA, while maintaining peak efficiencies up to 95%. A low-battery threshold and turn-off threshold can be individually programmed by the user, utilizing a single resistor divider connected to the Low Battery Input (LBI) pin. When the resistively-divided supply voltage on the LBI pin drops below approximately 1.22 V, the Low Battery Output (LBO) pin will become asserted. The dual-function LBI pin can alternatively be used as a Standby (SB) pin.

ORDERING INFORMATION

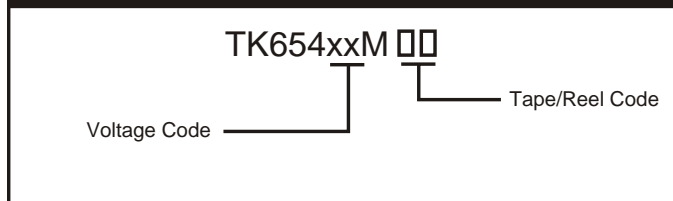

VOLTAGE CODE	
18 = 1.8 V	27 = 2.7 V
21 = 2.1 V	30 = 3.0 V
24 = 2.4 V	33 = 3.3 V
25 = 2.5 V	

TAPE/REEL CODE
TL: Tape Left

APPLICATIONS

- Battery Powered Systems
- Cellular Telephones
- Pagers
- Personal Communications Equipment
- Radio Controlled Systems
- Toys

Driving the SB pin low will disable the TK654xx and drop the quiescent current on the input supply to approximately 18 μ A.

Pulse Current Amplitude control is used to regulate the voltage at the V_{OUT} pin of the IC. When the output voltage of the TK654xx drops below the regulation threshold, a current pulse is transferred from the input supply to the output. The TK654xx utilizes a proprietary control scheme, where the average amplitude of the current pulse is varied depending upon the current loads. The proprietary architecture allows fast transient response and minimal ripple while maintaining ease-of-use and low component count.

The TK654xx is available in a miniature 6-pin SOT23L-6 surface mount package.

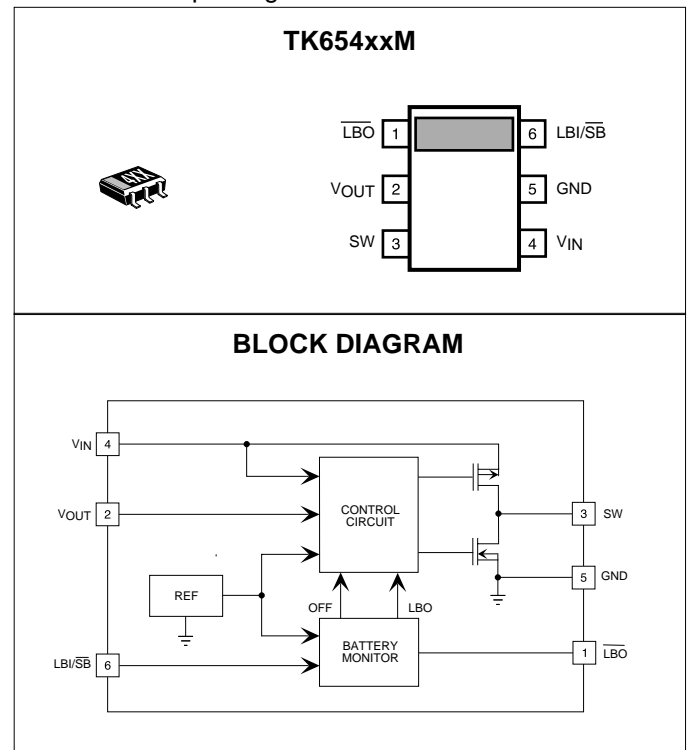

ABSOLUTE MAXIMUM RATINGS

All Pins Except GND	6.5 V	Operating Temperature Range	-20 to +80 °C
Power Dissipation (Note 1)	400 mW	Junction Temperature	150 °C
Storage Temperature Range	-55 to +150 °C	Lead Soldering Temperature (10 s.)	235 °C

TK654xx ELECTRICAL CHARACTERISTICS

Test conditions: $V_{IN} = 5\text{ V}$, $I_{OUT} = 1\text{ mA}$, $T_A = T_J =$ Full Operating Temperature Range, unless otherwise specified.

SYMBOL	PARAMETER	TEST CONDITIONS	MIN	TYP	MAX	UNITS
V_{IN}	Input Voltage		2		6	V
$V_{OUT(REG)}$	Output Voltage	$T_A = T_J = 25\text{ °C}$ (Note 2)	-3%	V_{REG}	3%	V
			-5%		+5%	V
$\Delta V_{OUT(LOAD)}$	Load Regulation	$I_{LOAD} = 0$ to 100 mA, (Note 3)		45	120	mV
$\Delta V_{OUT(LINE)}$	Line Regulation	$V_{IN} = 4$ to 6 V, (Note 3)		6	20	mV
$I_{Q(VOUT)}$	Quiescent Current into V_{OUT} Pin	$V_{OUT} = V_{OUT(REG)} + 50\text{ mV}$ (Note 3)		10	50	μA
$I_{Q(VIN)}$	Quiescent Current into V_{IN} Pin	$V_{OUT} = V_{OUT(REG)} + 50\text{ mV}$		15	65	μA
$V_{TH(LBI)}$	LBI Input Threshold	$T_A = T_J = 25\text{ °C}$	1.157	1.22	1.282	V
$V_{TH(SB)}$	Standby Threshold	$T_A = T_J = 25\text{ °C}$	1.157	1.22	1.282	V
$I_{B(SB)}$	SB Input Bias Current	Note 3		0		nA
		Note 4 at ($V_{TH(SB)} - 100\text{ mV}$)	400	720	1000	nA
$I_{OUT(MAX)}$	Maximum Output Current	(Note 3)		100		mA
$I_{OUT(SC)}$	Short Circuit Current	(Note 3)			250	mA
$I_{Q(CONV)}$	Converter Quiescent Current	(Note 3) $I_{OUT} = 0\text{ mA}$		24	90	μA
I_{STBY}	Converter Standby Current	SB pin = 0 V, Pin 1 open		18	65	μA
EFF	Converter Efficiency	$I_{OUT} = 50\text{ mA}$, (Note 3) $T_A = T_J = 25\text{ °C}$ (TK65418)	86	91		%
		$I_{OUT} = 50\text{ mA}$, (Note 3) $T_A = T_J = 25\text{ °C}$ (TK65433)	90	95		%
V_{DROP}	Dropout Voltage	$I_{OUT} = 50\text{ mA}$, (Note 5) $T_A = T_J = 25\text{ °C}$ (TK65418)		100	195	mV
		$I_{OUT} = 50\text{ mA}$, (Note 6) $T_A = T_J = 25\text{ °C}$ (TK65433)		75	145	mV

Note 1: Power dissipation is 400 mW when mounted as recommended. Derate at 3.2 mW/°C for operation above 25 °C. Power dissipation is 200 mW in Free Air. Derate at 1.6 mW/°C for operation above 25 °C

Note 2: $V_{REG} = 3.3, 3.0, 2.7, 2.5, 2.4, 2.1, 1.8\text{ V}$.

Note 3: When using test circuit.

Note 4: When using test circuit and ramping V_{IN} down.

Note 5: When using test circuit with \overline{SB} pin resistors removed and tied to V_{IN} . ($V_{IN} = 1.8\text{ V}$)

Note 6: When using test circuit with \overline{SB} pin resistors removed and tied to V_{IN} . ($V_{IN} = 3.3\text{ V}$)

TEST CIRCUIT

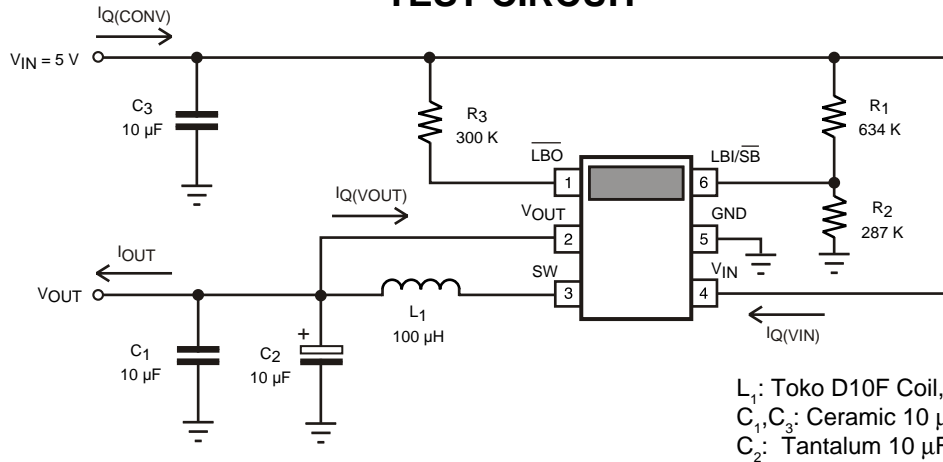

TYPICAL PERFORMANCE CHARACTERISTICS USING TEST CIRCUIT

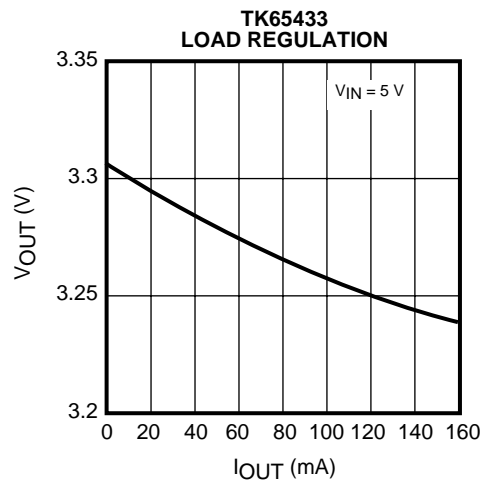
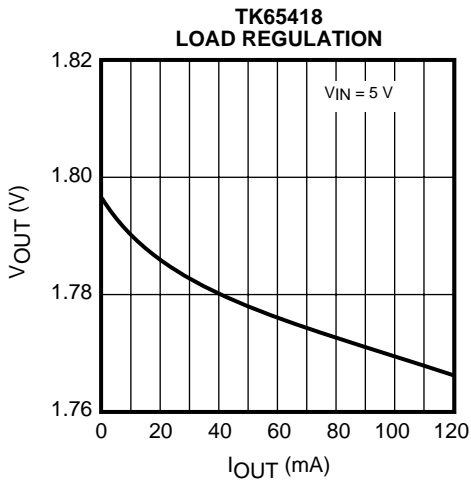
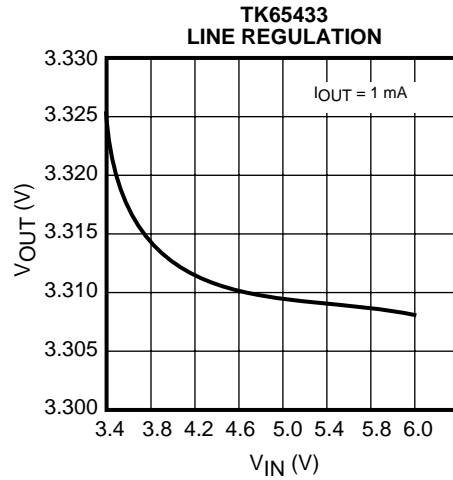
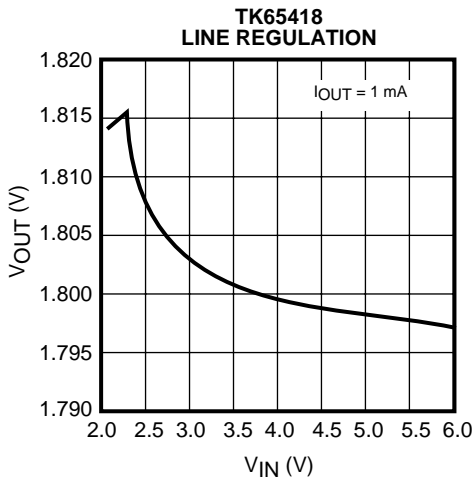

TYPICAL PERFORMANCE CHARACTERISTICS
USING TEST CIRCUIT (CONT.)

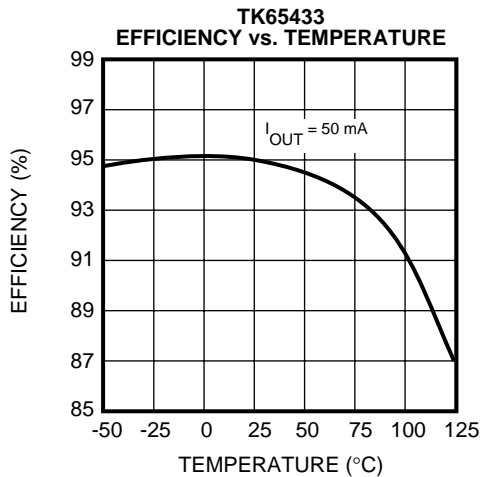
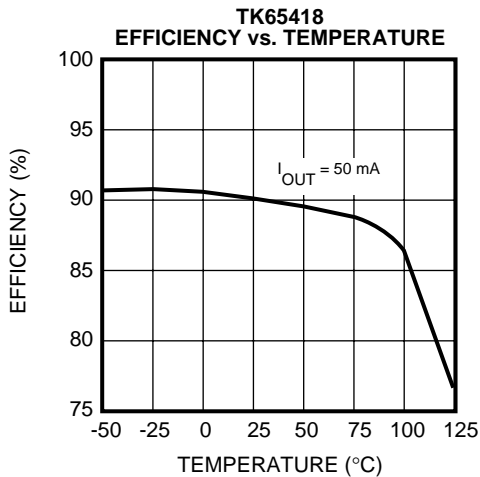
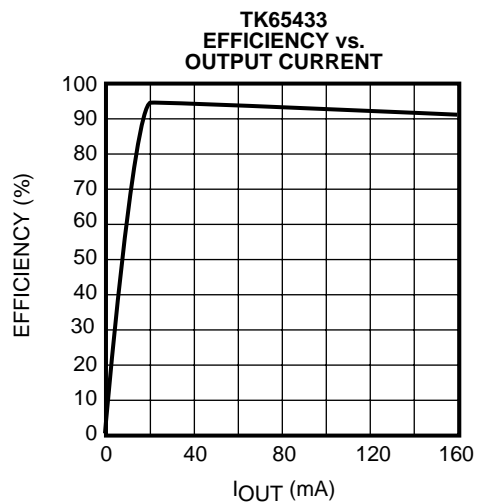
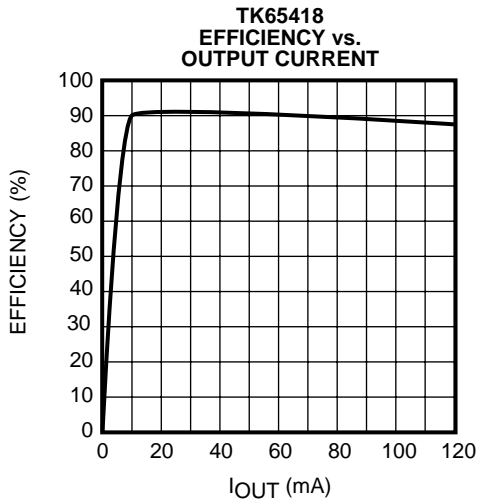
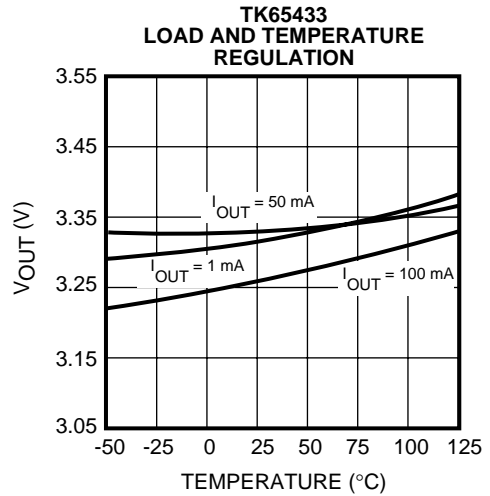
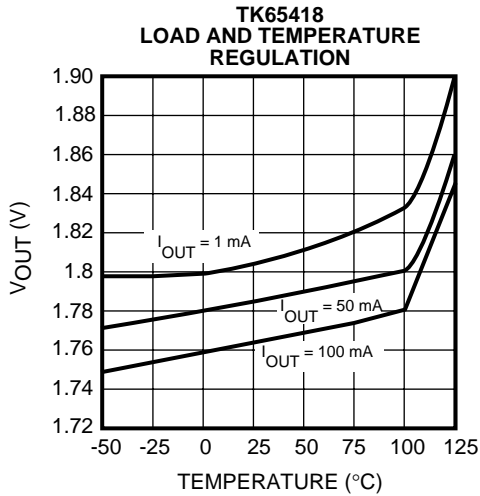

TYPICAL PERFORMANCE CHARACTERISTICS
USING TEST CIRCUIT (CONT.)

TK65418
CONVERTER QUIESCENT
CURRENT vs.
INPUT SUPPLY VOLTAGE

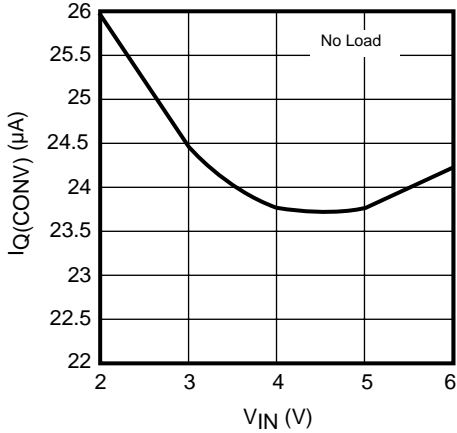

TK65433
CONVERTER QUIESCENT
CURRENT vs.
INPUT SUPPLY VOLTAGE

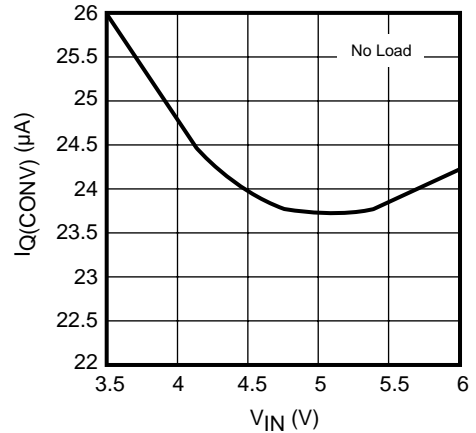

TK65418
CONVERTER QUIESCENT
CURRENT vs.
TEMPERATURE

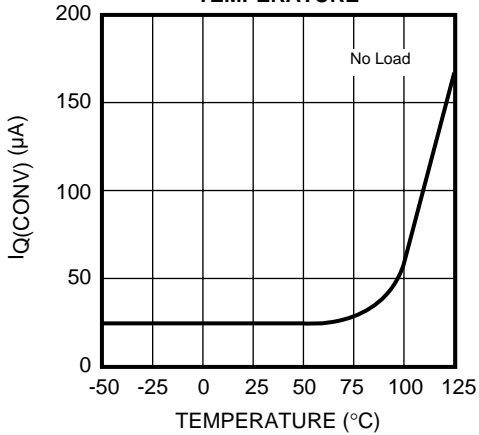

TK65433
CONVERTER QUIESCENT
CURRENT vs.
TEMPERATURE

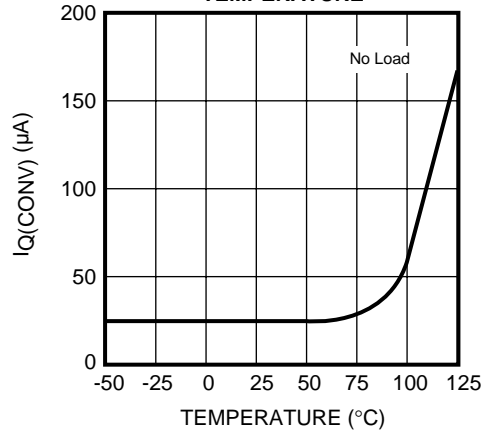

TK65418
STANDBY CURRENT vs.
INPUT SUPPLY VOLTAGE

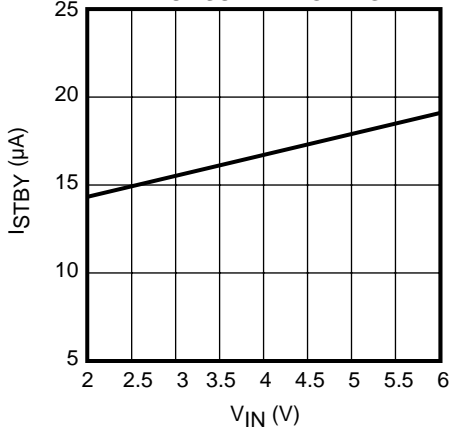

TK65433
STANDBY CURRENT vs.
INPUT SUPPLY VOLTAGE

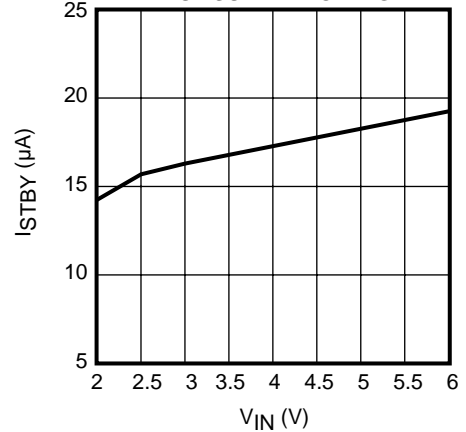

TYPICAL PERFORMANCE CHARACTERISTICS (CONT.)

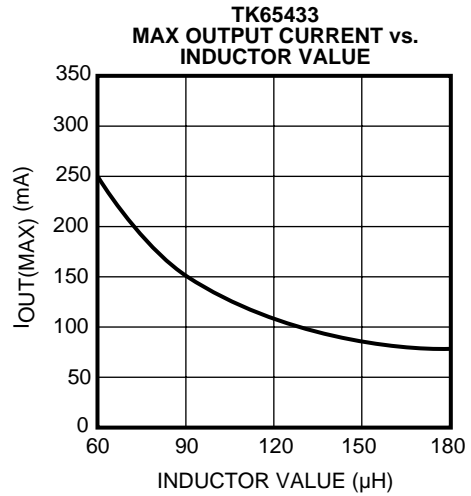
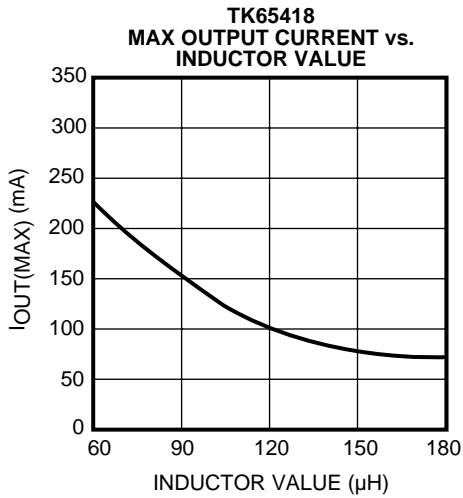
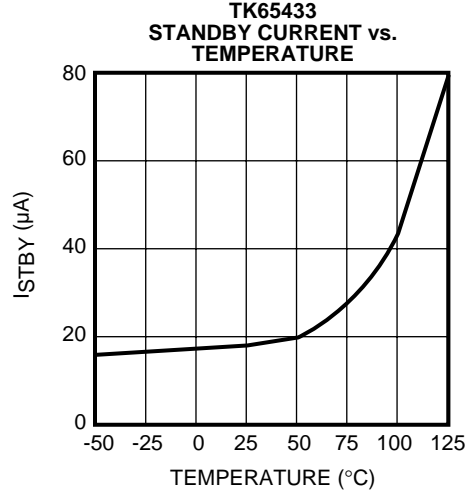
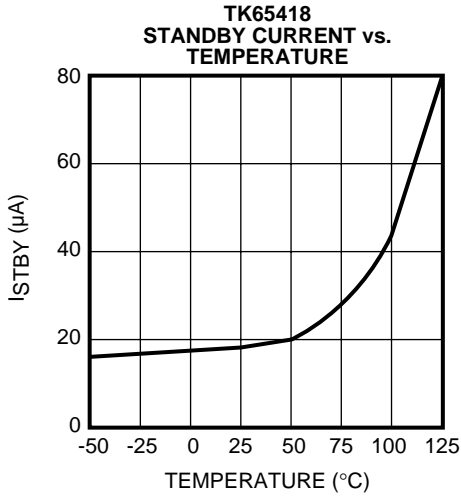

TYPICAL PERFORMANCE CHARACTERISTICS (CONT.)
USING RIPPLE TEST CIRCUIT

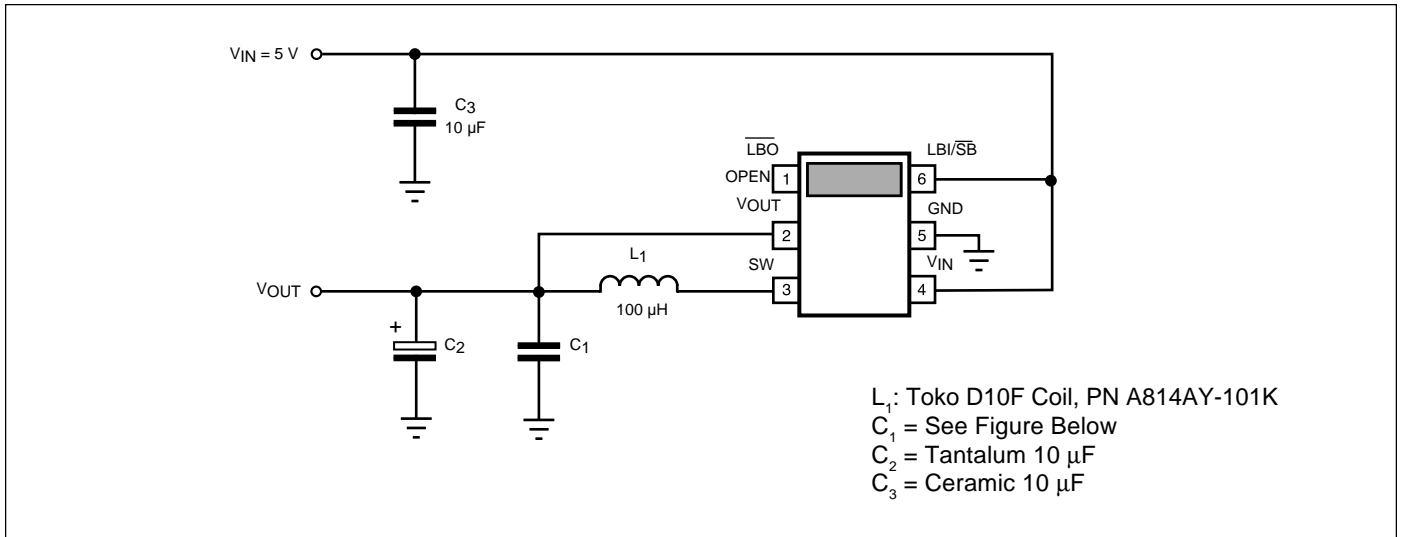

PEAK TO PEAK RIPPLE VOLTAGE

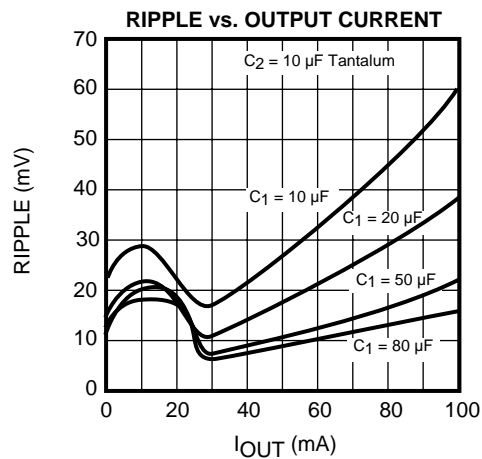

TYPICAL PERFORMANCE CHARACTERISTICS (CONT.)
STARTUP TRANSIENT WAVEFORMS

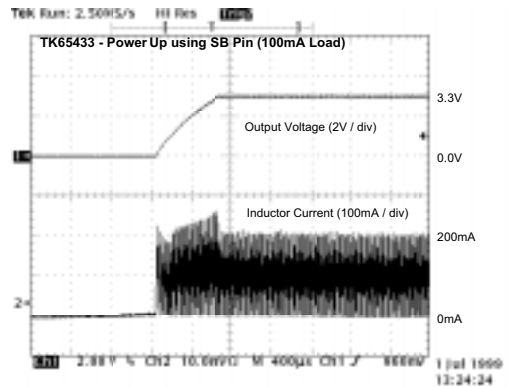
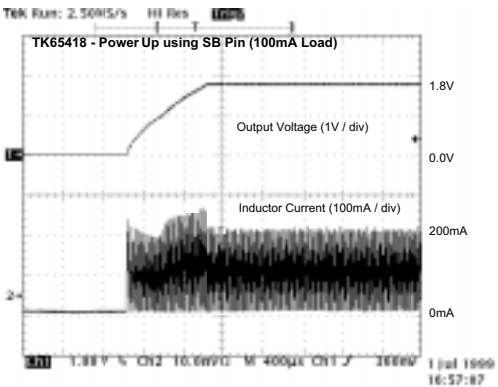
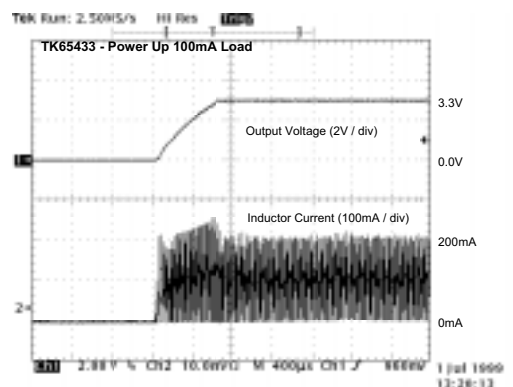
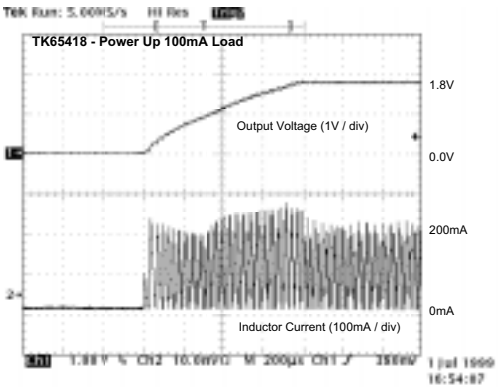
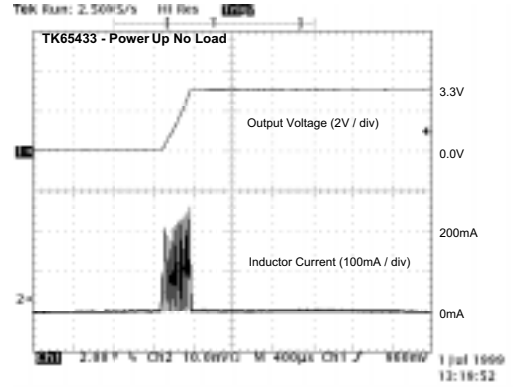
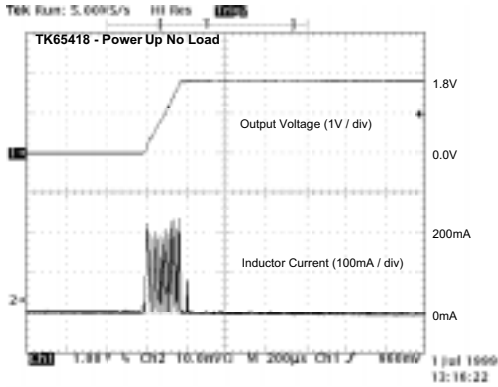

TYPICAL PERFORMANCE CHARACTERISTICS (CONT.)
TURN OFF TRANSIENT WAVEFORMS

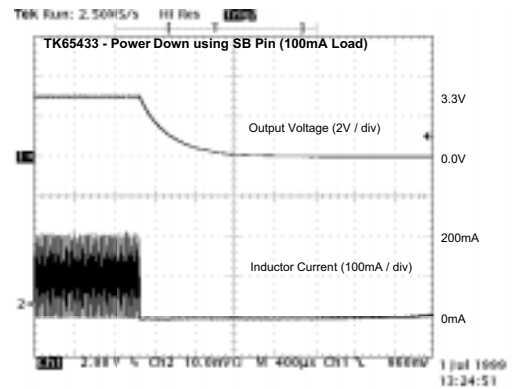
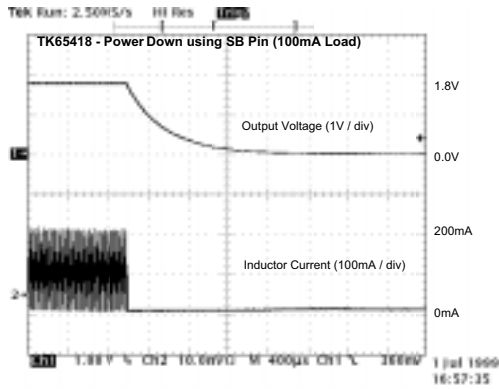

LOAD TRANSIENT RESPONSE WAVEFORMS

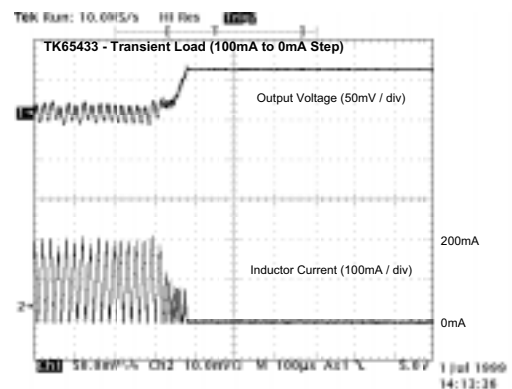
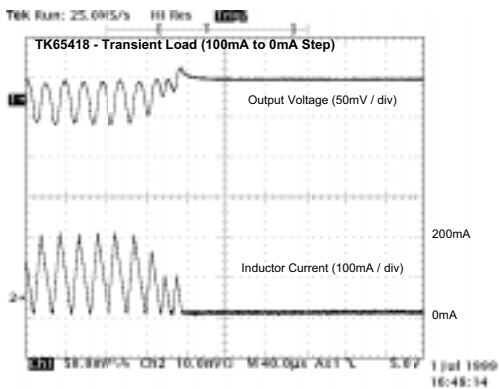
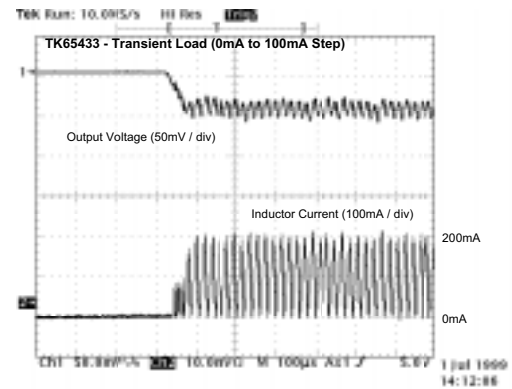
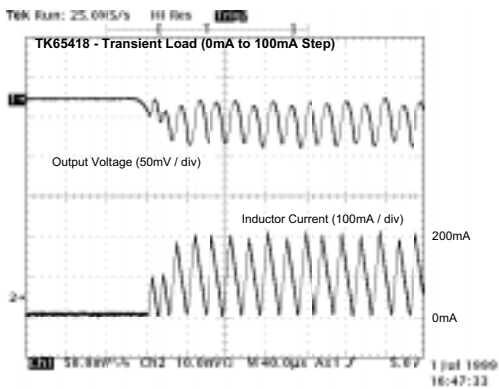

THEORY OF OPERATION

Figure 1 illustrates a circuit diagram for a simple buck (step-down) converter. Typically, the input voltage (V_{IN}) is greater than the output voltage (V_{OUT}). By modulating the switching action of switch SW1, the output voltage (V_{OUT}) can be regulated to a constant voltage that is relatively independent of variations in the input supply (V_{IN}) or the current load on the V_{OUT} node. The TK654xx contains all the control circuitry, logic, and power switch (SW1) for implementing a simple step-down or "buck" converter, as shown in Figure 1.

In general, a switching converter utilizing the TK654xx controller will be operating in one of three states:

1. "ON" STATE: During this state of operation SW1 will be turned on. Current through the inductive element (L) will be increasing at a rate proportional to the voltage difference between V_{IN} and V_{OUT} . In this state, there is a direct current path from the input supply to the output load through the inductor L.

2. "OFF" STATE: During this state of operation SW1 will be turned off. Current through the inductive element will be greater than zero and flowing either through the external schottky rectifier (D) or the synchronous rectifier internal to the TK654xx. During the "off" state, current through the inductive element (L) will be decreasing at a rate approximately proportional to V_{OUT} . In this state, the current drawn from the input supply is essentially zero. Current to the load is provided by stored energy in the inductive element.

3. "NULL" STATE: During this state of operation SW1 will be turned off. Current through the inductive element will be approximately zero. The internal synchronous rectifier will be turned off. All current demands of the load will be provided by the output filter capacitor (C). In this state, the current drawn from the input supply is essentially zero. Since the inductive current is zero, no additional energy is available from the inductor. If the current demands of the load are very light, the current will be provided by the stored charge in the output filter capacitor. If the voltage of the filter capacitor drops below the regulation threshold, an "on" state will be initiated and additional energy will be transferred from the input supply to the output.

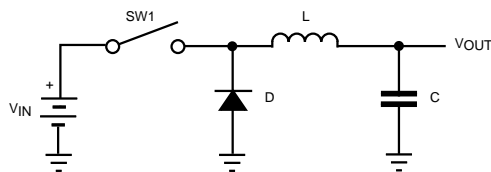

FIGURE 1: SIMPLE "BUCK" CONVERTER

The control scheme for the TK654xx forces the converter to step through the "on," "off," and "null" states in sequence. Assume that the controller is initially in the "null" state and V_{OUT} is greater than the regulation threshold. As soon as the output voltage drops below this threshold, the controller will switch from "null" state to the "on" state. During the "on" state, current through inductor (L) will be increasing. Current will flow from the input supply to the output capacitor through the inductive element. In this state, energy is transferred directly from the input supply to the output through the inductor. The maximum duration of the "on" state is inversely proportional to the difference between the input voltage (V_{IN}) and the output voltage (V_{OUT}).

The transition from the "on" state to the "off" state can be initiated by one of two different means. As mentioned above, the maximum duration of the "on" state is inversely proportional to the difference between the input voltage (V_{IN}) and the output voltage (V_{OUT}). If the duration of the "on" cycle exceeds this maximum, the controller immediately switches to the "off" state independent of other factors. Understanding that when the converter is in a dropout condition ($V_{IN} \approx V_{OUT}$), the maximum "on" time is infinite and the "on" state is constantly applied. By limiting the duration of the "on" cycle, the peak inductor current is also being limited. The second method for initiating the "off" cycle is triggered when the duration of the "on" cycle exceeds a minimum on-time duration and the output voltage (V_{OUT}) exceeds the regulation threshold. Therefore, the actual duration of the "on" cycle will vary between a minimum on-time ($T_{ON(MIN)}$) and a maximum on-time ($T_{ON(MAX)}$) depending upon the load current. At very light loads the on-time duration will be at a minimum; at very heavy loads the on-time will be at a maximum. This ability to vary the duration of the on cycle is a proprietary control scheme which can produce a ten-fold reduction in ripple when compared to competing devices.

The transition from the "off" state to the "null" state occurs after sufficient time has been allowed for the inductor current to return to zero. The actual duration of the "off"

THEORY OF OPERATION (CONT.)

cycle will be dependent upon the duration of the preceding "on" cycle and the sensed input and the output voltages.

The approximate duration of the "off" cycle can be predicted as follows:

$$T_{OFF} = T_{ON} \times (V_{IN} - V_{OUT}) / V_{OUT}$$

During the majority of the "off" cycle, a power switch is turned on. The turn-on point of the switch is synchronized with the initiation of the "off" cycle. The turn-off point is near the end of the "off" cycle. The addition of this switch reduces the voltage drop across the external rectifying device and provides significant improvements in converter efficiency.

BATTERY MONITOR SECTION

In a typical voltage monitor, which uses an external resistive divider for setting the voltage monitor threshold, the input bias current to the monitor pin is essentially zero. In this type of scenario, the voltage on the monitor input would be a resistively divided version of the battery voltage. The Battery Monitor of the TK654xx introduces a small feedback current ($-I_{LBI}$) which introduces a "plateau" into the transfer characteristics between the battery voltage and the voltage monitoring pin. The width of this plateau is dependent upon the current range of the feedback current ($-I_{LBI}$) and the values of the external resistor network. Figure 2 illustrates the typical relationship between the battery voltage (V_{IN}), the feedback current ($-I_{LBI}$) and the voltage on the monitoring pin (V_{LBI}).

In selecting a resistor divider network, there are typically two degrees of freedom when selecting values. The first criteria in selecting the divider is the ratio of the two resistors. Selecting the ratio defines the upper threshold of the voltage monitor. The second degree of freedom when selecting the resistor divider is the absolute resistance values. This second degree of freedom can be utilized to set a secondary monitoring threshold (V_{OFF}) lesser than the first.

Typically, when the battery voltage is relatively high, the voltage on the LBI input pin will be a resistively divided version of the battery voltage.

As the battery voltage drops, the voltage on the V_{LBI} pin will drop proportionately. When the voltage on the LBI input pin passes through approximately 1.22 V, the output of the first comparator (LBO) will transition from a high to a low state and the synchronous rectifier N-channel MOSFET will stop being switched. There is about 50 mV of hysteresis between the LBO trip point and its reset point. Shortly after the LBO output has been asserted, as the input voltage continues to drop, the magnitude of the current out of the V_{LBI} pin will begin to flow and proportionately increase as the input voltage decreases. An op-amp feedback loop internal to the Battery Monitor of the TK654xx will attempt to maintain the voltage on the V_{LBI} pin at a constant value of approximately 1.22 V (thus, the plateau). As the battery voltage continues to drop, there comes a point where the feedback current stops increasing at about 720 nA. At this point, the voltage on the LBI pin will resume a proportional drop with the input voltage and the TK654xx converter will turn off.

For details on how to properly select the resistor divider, refer to the "Design Considerations" section.

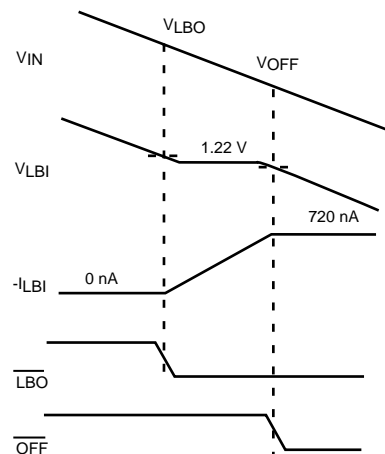

FIGURE 2: BATTERY MONITOR OPERATION GRAPHS

PIN DESCRIPTION

INPUT VOLTAGE PIN (V_{IN})

This pin is the positive input supply for the TK654xx. Current flowing into this pin provides power to the IC and to the converter output through the inductive element. During the "on" state, the majority of the current flowing into this pin is flowing through the inductor. During the "off" and "null" states, the current into this pin is very small (approximately 18 μ A). The voltage source driving this pin should have relatively low AC impedance. Good design practices dictate decoupling to the GND pin.

GROUND PIN (GND)

This pin provides the ground connection for the IC.

OUTPUT VOLTAGE PIN (V_{OUT})

This pin senses the output voltage of the buck converter. Input current into this pin is very low (approximately 10 μ A). The output voltage is resistively divided in the IC and compared to the bandgap voltage. If the output voltage remains greater than the regulation threshold, the TK654xx remains in a standby state. As soon as the output voltage drops below the regulation threshold, the TK654xx will initiate an "on" and "off" cycle to boost the output voltage.

SW PIN

This pin is normally connected to one pin of the inductive element and an external optional passive schottky rectifier (optional to increase efficiency). The external schottky rectifier is connected between this pin and ground. It is recommended that the lead lengths between the rectifier and the pins of the TK654xx be kept as short as possible to minimize parasitic inductances.

LOW BATTERY INPUT/STANDBY PIN (LBI/\overline{SB})

This input pin is capable of performing two separate functions which will be dependent upon the application's requirements.

In some applications, this input pin can be used as a Low Battery Input (LBI). In such an application, this input pin is typically driven by a resistively divided version of the input supply (V_{IN}). For detailed information on selecting values for the resistor divider, please refer to Design Considerations on pages 13 and 14.

The second function of this pin is to act as a Standby (SB) input. If this pin is greater than approximately 1.22 V, the converter will operate normally. Driving this pin low will force the converter into a "standby" mode where the DC/DC conversion is disabled. In this "standby" mode, the current through the inductive element goes to zero; only the filter capacitor will provide current to the output.

If neither the Low-Battery or Standby features are needed, this input pin should be connected directly to the V_{IN} pin. Under this mode of operation, the TK654xx will not turn off. As the input voltage approaches the regulation voltages the TK654xx will act as a P-Channel pass element with approximately a 2 Ω resistance, going into the linear mode of operation.

LOW BATTERY OUTPUT PIN (\overline{LBO})

This pin provides a Low Battery Output (LBO) signal to indicate when the voltage on the LBI input pin has dropped below the low battery threshold (1.22 V). This open-drain output is normally pulled up to either the input supply or the output supply through a resistive pull-up. The LBO output pin provides an active-low output. If the LBO is not going to be used, the pin may be left open.

DESIGN CONSIDERATIONS

INDUCTOR SELECTION

One of the positive features of the TK654xx is the ability to limit the magnitude of the short circuit current without the need for external current sensing resistors. Since the maximum on-time duration is limited, and the converter always operates in discontinuous conduction mode (DCM), the maximum load current is essentially dependent upon the selection of the inductor value. The following table defines the maximum load current as a function of the inductor value.

L	MAX LOAD
47 μ H	305 mA
100 μ H	140 mA
220 μ H	65 mA
470 μ H	20 mA

OUTPUT FILTER CAPACITOR SELECTION

The purpose of the filter capacitor on the output is to temporarily provide current to the load as inductor current is ramping upward or downward. In general, larger capacitors will reduce the magnitude of the ripple.

INPUT FILTER CAPACITOR SELECTION

Typically, the power supply or battery source connected to the V_{IN} pin contains an inductive and resistive component. Since the current draw from the input supply varies with time, such a scenario would exhibit ripple on the input supply. Adding a bypass capacitor between the V_{IN} pin and ground, in some cases, will dramatically decrease ripple on the input supply. An input supply bypass capacitor in the range of 1 to 10 μ F will work well for most converter applications up to 100 mA. Bypass capacitors on the input pin should exhibit relatively good ESR characteristics.

LOW BATTERY MONITOR

The TK654xx utilizes a proprietary method for sensing and handling low battery voltages. Using a single input pin and resistive divider, the TK654xx not only provides an early warning system of a low battery, it also provides a later

shutdown threshold which occurs at a voltage lower than the LBI threshold. Both the LBI threshold and the shutdown threshold can be set utilizing a single resistive divider.

For the following explanation, please refer to Figure 3. When the battery voltage (V_{IN}) is very high, the current from the LBI input pin is essentially zero. The voltage on the LBI input pin is simply a resistively-divided version of the V_{IN} pin.

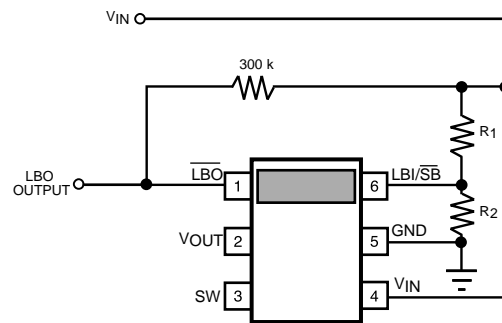

FIGURE 3: LOW BATTERY MONITOR

As the voltage on the LBI input pin drops and passes through the bandgap voltage (1.22 V), the LBI input pin will begin to source current. At this same point, the LBO output will be asserted. The assertion of the LBO output is typically used as an early warning, indicating that battery failure is approaching.

As the voltage on the V_{IN} pin continues to drop, the current sourced by the LBI input pin will continue to linearly increase with the drop-in supply voltage. The current from the LBI input pin will attempt to keep the voltage pin at the same potential as the bandgap reference (1.22 V). Throughout this region, the LBO output is continuously asserted.

The current sourced from the LBI input pin is internally limited to a maximum of approximately 720 nA. As mentioned above, the current from the LBI input pin continues to increase as the supply voltage drops. When the current from the LBI input pin reaches the 720 nA threshold, the TK654xx will turn off. This essentially provides a second threshold, less than the LBI/SB threshold, where the system will turn off.

DESIGN CONSIDERATIONS (CONT.)

The thresholds for the Low Battery Input (LBI) and the turnoff (V_{OFF}) can be set independently using a single resistive divider. Equations and a chart for selecting the LBI and V_{OFF} thresholds are provided below:

$$\text{LBI threshold} = 1.22 \text{ V} \times (R_1 + R_2) / R_2$$

$$V_{OFF} \text{ threshold} = \text{LBI threshold} - 720 \text{ nA} \times R_1$$

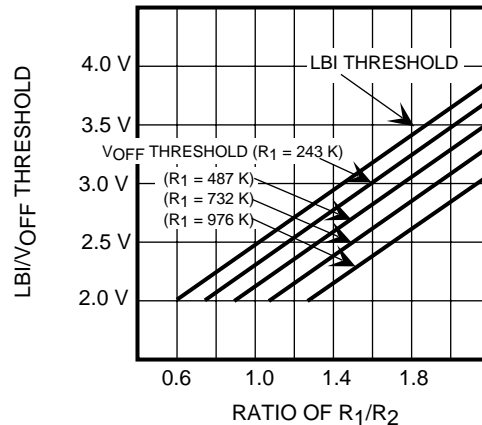

DROPOUT CHARACTERISTICS

In battery powered applications, the input supply is not typically a constant value. As the battery discharges, the input voltage will approach the output voltage. As the voltage on the input of the converter drops, the following two characteristics can be observed: **(a)** as the battery voltage drops, output ripple will increase, **(b)** at very low battery levels and high current loads, the output voltage may drop significantly below the regulation threshold.

In some applications, the above characteristics may not present a problem. For those applications that may be sensitive to these characteristics, the LBO output can provide an early warning system indicating that battery failure is near. As the battery voltage continues to drop, the turnoff feature of the TK654xx will ultimately turn the converter off (see LBI Indicator section).

NOISE CONSIDERATIONS

GENERAL

Because of the switching waveforms inherent to the operation of DC-DC converters, they tend to be noisier than their linear counterparts. A DC-DC converter uses switching techniques to do the power conversion at higher efficiencies than a linear regulator at the price of noisier output ripple. The TK654xx is no exception to this, even though the proprietary architecture chosen was centered in providing the user fast transient response, low quiescent current and minimum ripple.

INPUT/OUTPUT CAPACITORS (GENERAL)

By the nature of their operation, DC-DC converters generate large switching currents on both the input and output of the circuit. The input and output capacitors should be as large as practical with a low Equivalent Series Resistance (ESR). Since low temperatures cause the value of capacitance to decrease and the ESR to increase, care should be taken to select capacitors that have acceptable characteristics over the desired operating temperature range.

INPUT CAPACITOR

The function of the input capacitor is to reduce the supply impedance and to provide sufficient input current during switching for stable circuit operation. The input capacitor should be physically located as close as possible to the converter to minimize the lead inductance and to reduce the impedance of the source at high frequencies. By having the capacitor close to the converter, the switching current pulses are supplied locally by the capacitor instead of running across the printed circuit board by long etch runs. This greatly reduces the noise on the board.

OUTPUT CAPACITOR

The function of the output capacitor is to reduce the ripple voltage appearing on the converter output. The output ripple voltage is the AC voltage which appears on the regulated DC output. It is inherent in all DC-DC converters and is the result of the conversion of the input DC to AC and then back to output DC. The output ripple is the result of two factors, which are 90° out of phase. The first factor is the result of the change in the stored charge of the output capacitor as it is charged by the switching current from the converter and then discharged by the load current. This factor determines the value (μF) of the output capacitor. The second factor is the product of the capacitor's charge/discharge current times its ESR. This factor determines the requirement for low ESR capacitors. In DC-DC converters, the ripple produced by the capacitor ESR is often larger than the ripple produced by the change in charge. For this reason, high quality ceramic, tantalum, or aluminum filter capacitors are required to minimize the output ripple. This contribution to output ripple and noise can also be minimized by the addition of a small ($0.01 \mu\text{F}$ to $0.1 \mu\text{F}$) ceramic capacitor in parallel with the bulk output capacitor. Adding a Pi filter as shown below (Figure 4) can further reduce output noise. The Pi filter has a tendency to reduce the efficiency by a couple of percentage points and yet the noise improves by 20 dB/decade.

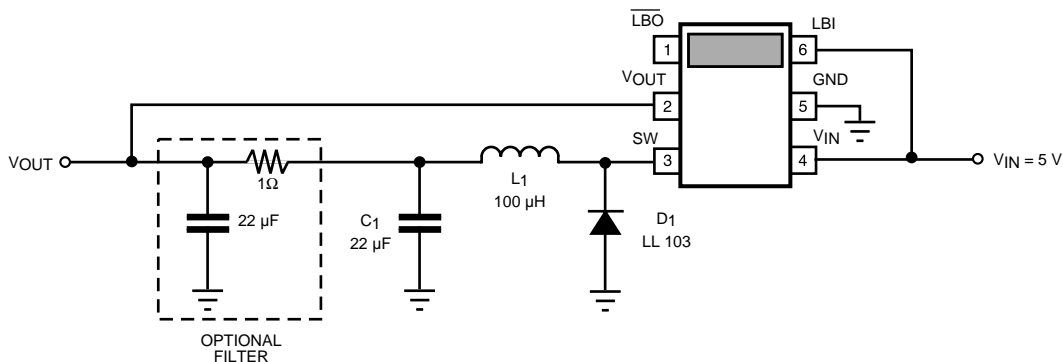

FIGURE 4: OPTIONAL PI FILTER

NOISE CONSIDERATIONS (CONT.)

COIL

The coil magnetic field can also be a source of noise. This noise is more characteristic of radiated Electromagnetic Interference (EMI). This radiated noise can interfere with RF communications systems if care is not taken by the system designer. A shielded coil can improve this source of EMI.

SNUBBER

When the inductor current flowing through the output diode decays to zero, the parasitic capacitance at the switch pin (pin 3) resulting from the internal switch and external diode has energy which rings back into the inductor. This high frequency ringing is an undesirable source of radiated noise. Fortunately, due to the low amount of energy in this ringing, a simple RC snubber as shown in Figure 5 easily eliminates it. In low noise applications the RC snubber is recommended, although an efficiency penalty of approximately 2% will result.

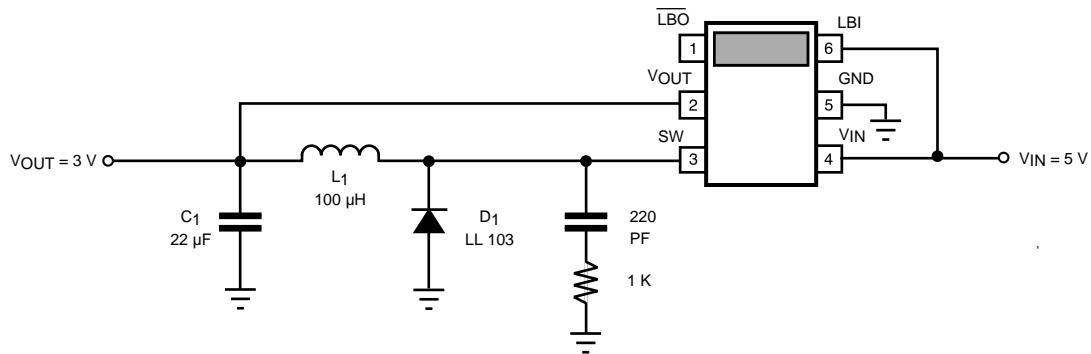

FIGURE 5: OPTIONAL SNUBBER

COIL CONSIDERATIONS

There are several issues to consider when choosing the proper coil for the TK654xx Step-Down Converter.

An important consideration is the coil manufacturer. Toko Inc. has been in the coil business for many years and has been a leader in this market with high quality of product, low cost, and high volume delivery distribution.

The test circuit in this data sheet uses the D10F type series for its low resistance (0.27 Ω for 100 μH). This coil should be considered when the user is interested in high efficiency.

TYPE D10F

For Reflow Soldering

Frequency Range: 1 kHz ~ 1 MHz

Inductance Range: 10 ~ 1500 μH

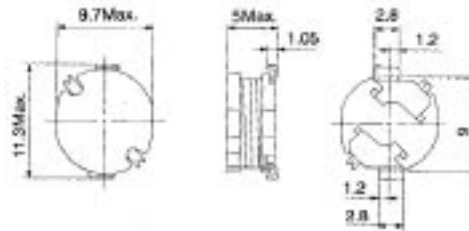

Unit:mm

A major issue today is space as well as height. Toko makes a low profile surface mount coil series which may accommodate this requirement. The D52 series dimensions are shown below. The 100 μH coil has a maximum rated DC resistance of 1.6 Ω.

TYPE D52FU

Frequency Range: 1 kHz ~ 2 MHz

Inductance Range: 100 μH ~ 6800 μH

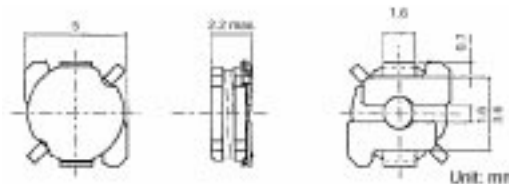

Unit: mm

FEATURES

- Low profile (2.0 mm typ. height) and 5 mm square
- Magnetically shielded version, unshielded also available
- Available on tape and reel for auto insertion
- Suitable for reflow soldering

COIL CONSIDERATIONS (CONT.)

Toko makes other series of coils which fall between the D10F and D52 series.
The D73/D75 coils should be kept in mind.

TYPE D73C, D75C

For Reflow Soldering

Frequency Range: 10 kHz ~ 1 MHz

Inductance Range: 1-560 μ H



D73C

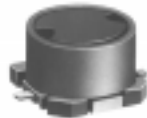

D75C

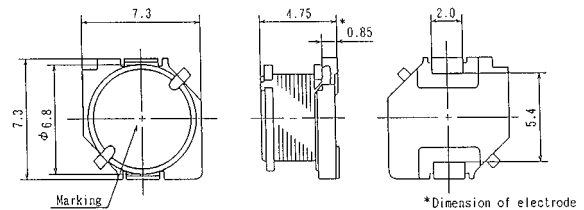

D75

Unit:mm

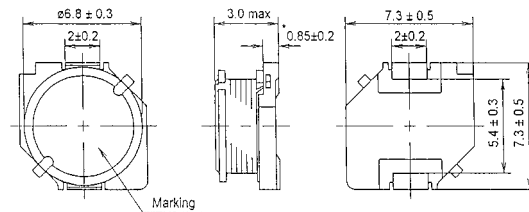

D73

Unit:mm

FEATURES

- Miniature surface mount type
- Low profile (3.0 ~ 5.1 mm max height)
- Inductance range: 1-560 μ H
- Available in magnetically shielded or unshielded versions
- Supplied on tape and reel for auto insertion
- Ideal for a variety of DC-DC Converter inductor applications

APPLICATION INFORMATION

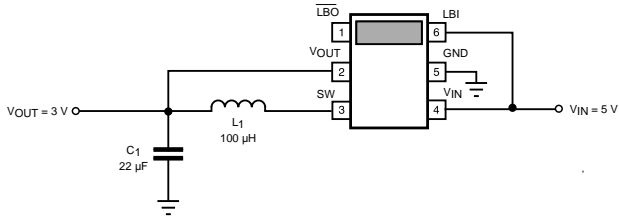

FIGURE 6: MINIMUM DEVICE COUNT

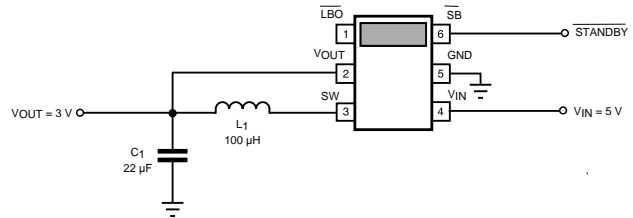

FIGURE 7: CONVERTER WITH STANDBY

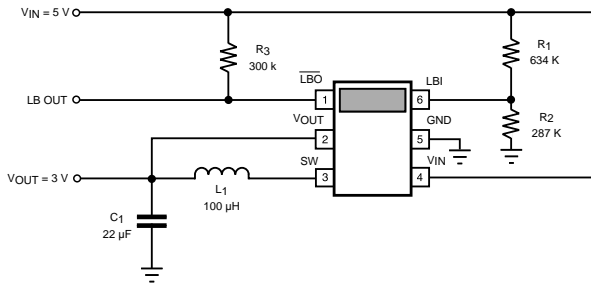

FIGURE 8: LOW BATTERY DETECTOR

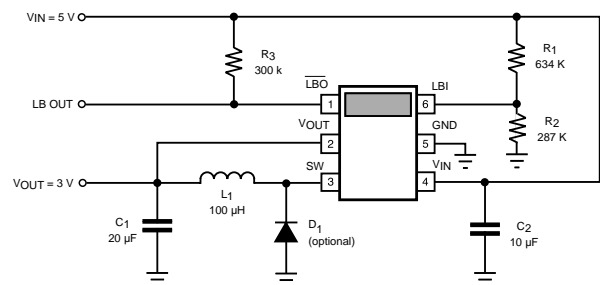

FIGURE 9: EVALUATION BOARD SCHEMATIC

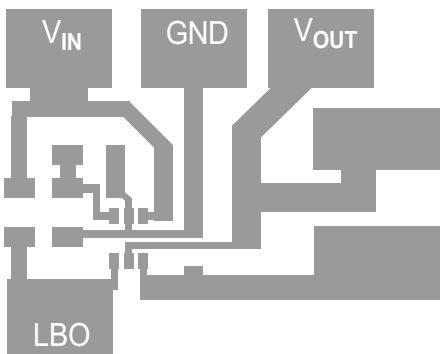

FIGURE 9B: EVALUATION BOARD ARTWORK

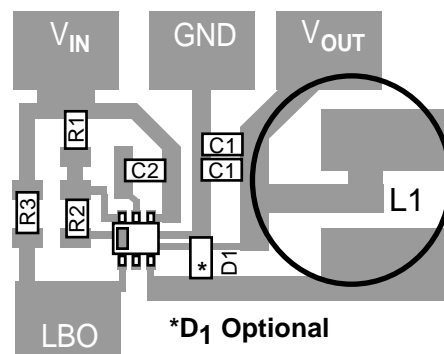

FIGURE 9C: EVALUATION BOARD COMPONENT PLACEMENT

APPLICATION INFORMATION (CONT.)

The portable market, computing market and communications market, appear to not only be growing very fast, but also to be converging.

Whether a computer incorporates communications capability or the phone incorporates the data / file transfer capability, both markets as we approach the next millenium certainly are portable and require high efficiencies as well as long standby times in order to extend the battery life. As the user gets more and more comfortable with his portable system, he will want longer and longer time before recharging the battery.

WIRELESS PORTABLE SYSTEM USING LINEAR REGULATORS

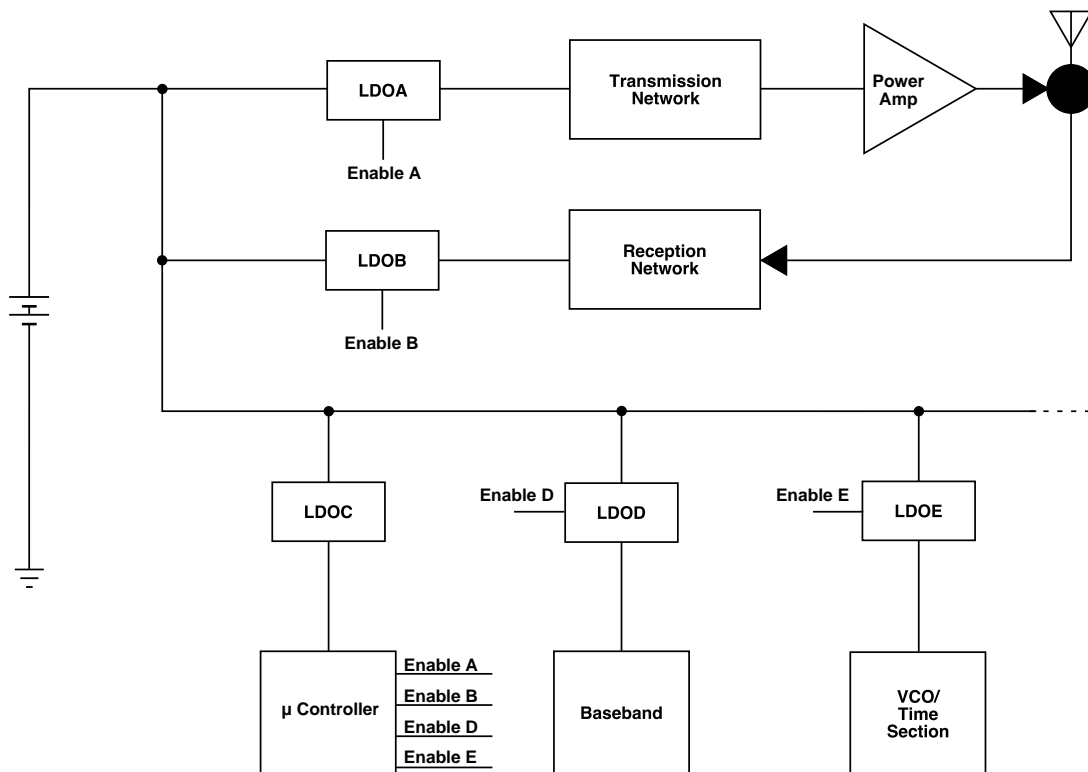

FIGURE 10: Linear regulators power up wireless application

APPLICATION INFORMATION (CONT.)

New microprocessors are earnestly addressing this power issue by reducing the voltage. Battery manufacturers are waking up right before the end of the century with the introduction of the “polymer electrolyte battery” which allows for higher volumetric and gravimetric densities. Furthermore, these types of batteries come with much better form factors.

Unfortunately the wireless transmit and receive section of the portable system is very sensitive and requires very clean analog voltages to keep a clean reception and transmission. This RF requirement reigns over the power management section of the system and creates a dilemma to the system engineer. How do you extend the battery life with “efficient switchers” when they are so “dirty” in performance compared to “linears”?

The industry has made attempts to get away from a sole linear system shown in Fig. 10 by considering a “PWM” switcher in front of the linear as shown if Fig. 11.

The system of Fig. 10 has the advantage of very clean voltages for the RF section, but lacks high efficiency. Specifically as the processor voltage drops and the battery makers refine the Li-Polimer battery (which ranges from 2.7V min to 4.2V max).

The system of Fig. 11 has the advantage of high efficiency followed by clean RF due to the linears, but lacks the ability to turn off (turn on) fast when the system is in standby operation. This is specifically due to the PWM architecture which uses Continuous Conduction Mode (CCM) to build up the current in the coil.

WIRELESS PORTABLE SYSTEM USING PWM SWITCHER TO IMPROVE EFFICIENCY

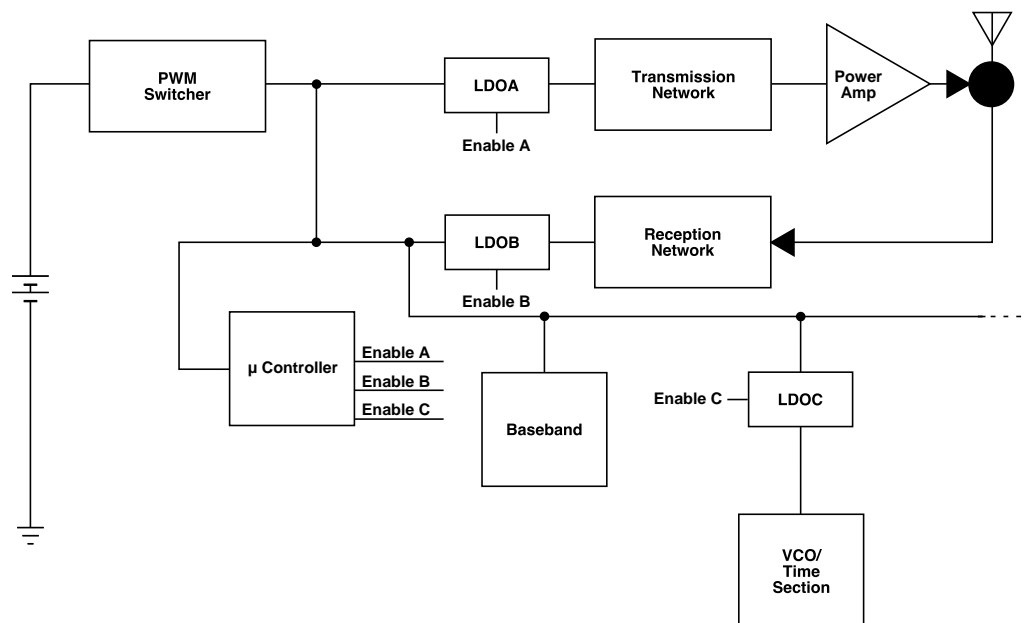

FIGURE 11: PWM Switcher embedded to improve wireless system efficiency

APPLICATION INFORMATION (CONT.)

The industry is presently in a frame of mind that unless the switcher is PWM with a fixed frequency (to fix the harmonics away from the RF), the wireless RF section will not be clean. It is the intention of this application to open the mind of system designers to consider this new concept which addresses a real issue. Several major IC manufacturers of PWM step down converters are taunting the "Burst Mode" capability. This can be misleading since under the burst mode, the fixed frequency of the PWM is no longer present. (Therefore harmonics are all over the place). Furthermore, the purpose of the Burst Mode is to allow the system to go into a standby mode in order to save battery life. Yet these state of the art PWMs with Burst mode ability still lack in response time due to the architecture which requires the coil current to slowly build up. This build up in current is a barrier to the present day requirements.

This Buck and Linear Wireless application proposes a system as shown in Fig. 12, which allows for all 3 important aspects of the design:

- 1) Clean RF
- 2) High efficiency (At full, mid, and light loads)
- 3) Low standby currents with fast "wake up" response.

The approach shown in Fig. 12 requires a new architecture for the Buck (Step down) switching converter with very fast transient characteristics, specifically during the transition from a Buck mode to Linear mode while a RF transmission/reception is eminent or during a wake up out of standby mode.

WIRELESS PORTABLE SYSTEM USING BUCK AND LINEAR REGULATORS

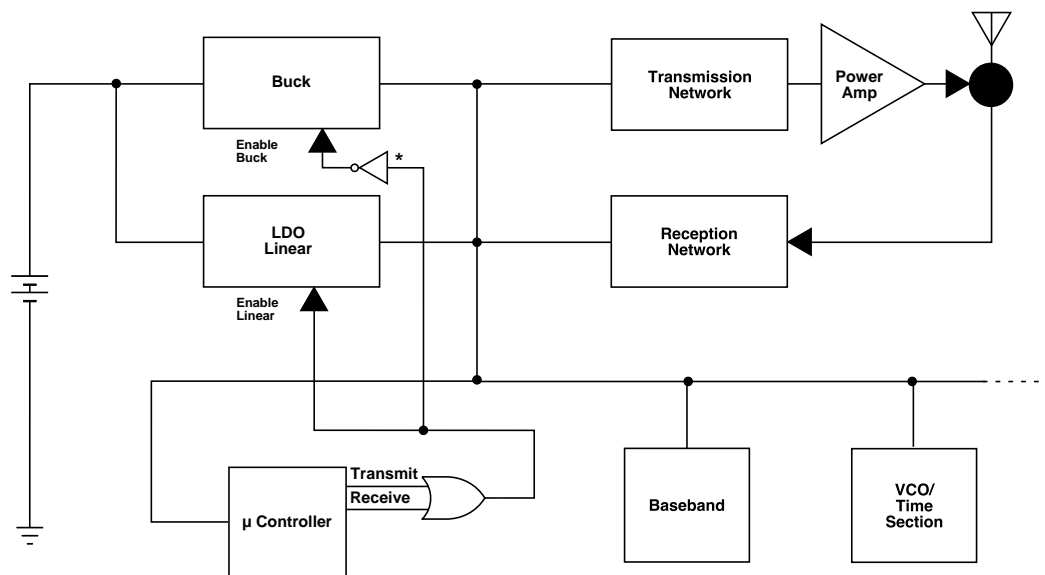

* Not necessary if LDO is active low

FIGURE 12: Buck and Linear embedded to improve wireless system efficiency, standby time, and clean RF

APPLICATION INFORMATION (CONT.)

Toko Inc. has come up with such a proprietary architecture implemented in their TK654XX switching step down converter. This device is full of features as itemized in the following section:

TK654XX Features

- 1) Minimum pin count. Only 6 pins in a SOT23L package
- 2) Minimum external components required:
Coil and Filter cap
- 3) Synchronous Rectification
- 4) Extremely low operating current (25uA).
- 5) 18uA Standby Currents
- 6) Internal power devices good for greater than 200mA loads
- 7) Inherent short circuit protection
- 8) No instabilities
- 9) Fast transient response
- 10) High efficiencies up to 95%
- 11) Regulation down to 1.8V
- 12) Proprietary architecture specifically aims at low ripple voltage.
- 13) Low Dropout operation (100% Duty Cycle)
- 14) Designed for battery operated equipment
- 15) Battery Monitor included
- 16) Easy to design with (Reduce the coil to increase the load current)

Explanation of Figs. 10, 11, 12 follows:

Figure 10, shows a battery operated system with communications capability. The microcontroller is programmed to turn on / off the Linear Low Dropout regulators (LDOs) at the appropriate time. This enabling capability is useful in extending the battery life. Please note the LDO C, which powers the microcontroller is always active.

Figure 11, takes advantage of LDO C having to be active continuously and replaces it with a PWM step down controller. Though the PWM is always active like the LDO C of Figure 10, the PWM is more efficient and therefore is penetrating the Wireless market in order to increase battery life. It must be pointed out in Figure 11, the role of the LDOs is important to maintain the clean voltages for Transmission and reception modes. Figure 11 also points out that if there is small activity with the microcontroller which controls the other LDOs, the system could trip to the "Burst Mode" taunted by semiconductor manufacturers. This mode is intended to reduce the current consumption of the PWM and increase the overall battery life. Unfortunately, the speed that this Burst mode-to-PWM mode can react in is not very fast. Those systems, which are compromised to increase response time, will inevitably hurt in ripple and therefore noise performance.

Figure 12, replaces the PWM with a Buck (step down) converter which has a unique architecture to respond very fast from "Burst mode" to full load operation and a linear in parallel, rather than in series which can be enabled at the time the system requires to transmit or receive. It is only due to the clean RF that the LDO is necessary. The majority of the time these wireless systems are in a mode which can operate with some noise in the main voltage line. Some readers may have noticed that Figure 12 only requires 1 LDO versus 3 LDOs in Figure 11. This principal may point out that the overall system may turn out to be more cost effective. The system shown in Figure 12, therefore not only extends the overall battery life by allowing the system to go into standby modes where the overall current is in the order of 25 uA, but at full load can run in the 95% efficiency (no Transmission / Receive mode). Figure 12 can maintain the clean RF requirements for wireless communications and reduce the overall cost.

APPLICATION INFORMATION (CONT.)

Wireless Application Extend battery life, yet keep RF clean

Application results with waveforms for TK65430 in a Buck and Linear Mode

Figure 13 is a schematic of an application board available from Toko as APO14-99 from which the results shown below were obtained. This application uses the TK11330 Low Dropout Regulator with the control function enabling the regulator on when this control pin is low.

Note A: This is a low ESR (80 mΩ) capacitor from AVX TPSD107 M010R0080

Note B: Coil used to obtain waveforms was D63LCB type A921CY-101M from Toko

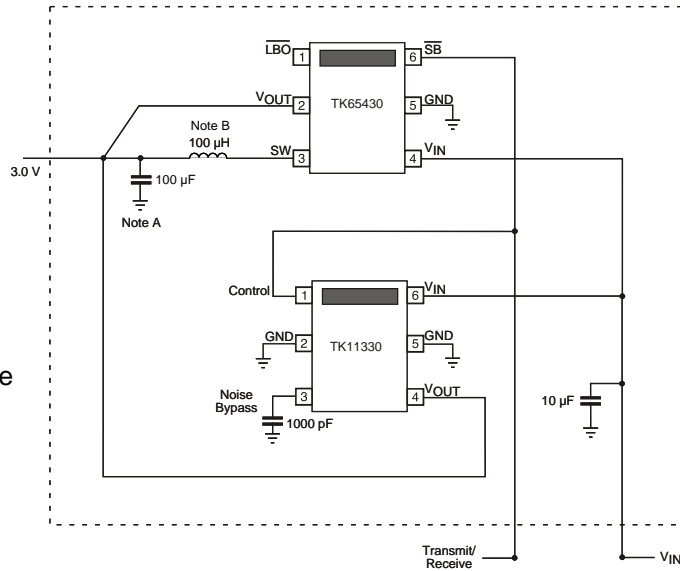

FIGURE 13: BUCK AND LINEAR SCHEMATIC

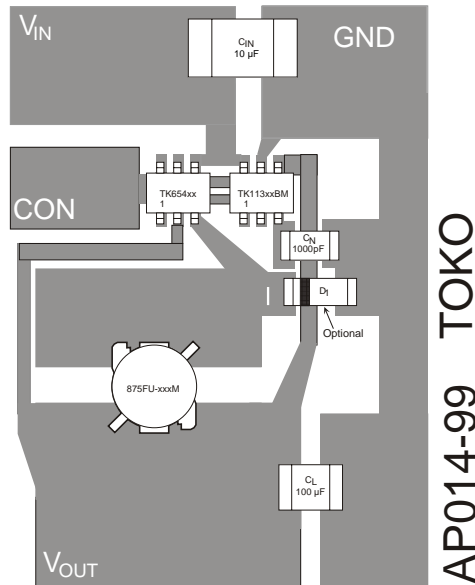

FIGURE 14: BUCK AND LINEAR APPLICATION BOARD LAYOUT

APPLICATION INFORMATION (CONT.)

TK65430 in a Buck and Linear Mode

During the transient response between the “Buck” and “Linear” control modes the output voltage needs to stay within the regulation requirements.

The following scope pictures show the changes in the output voltage during these transients. As can be seen, the maximum drop is about 80 mV and maximum overshoot is negligible.

In switching from the “Buck” mode to the “Linear” mode the settling time is less than 250 μ sec over the supply range of 5 V to 3.2 V for this 3.0 V application.

$V_{IN} = 5\text{ V}$ $I_{OUT} = 100\text{ mA}$

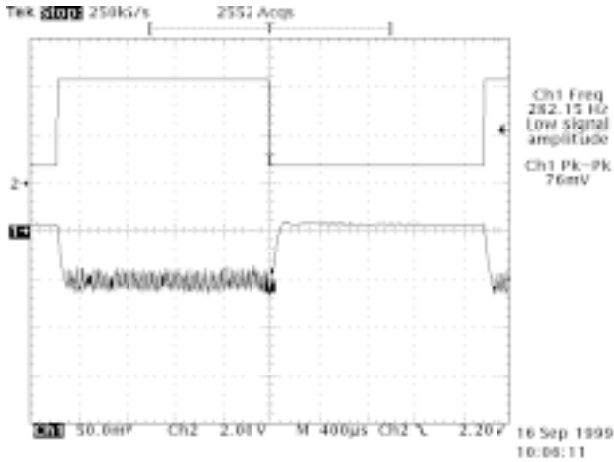

Full Cycle

$V_{IN} = 3.2\text{ V}$ $I_{OUT} = 100\text{ mA}$

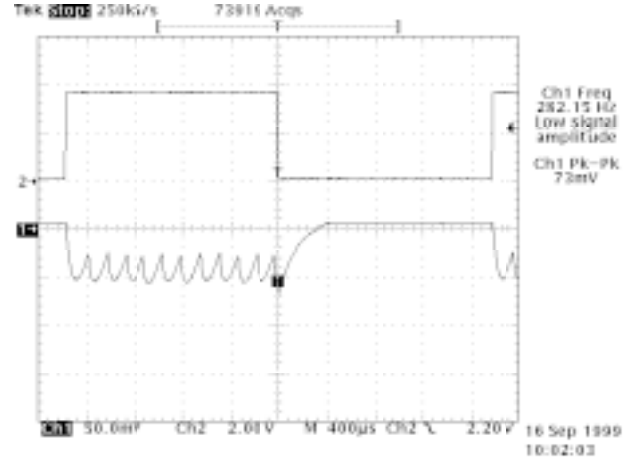

Full Cycle

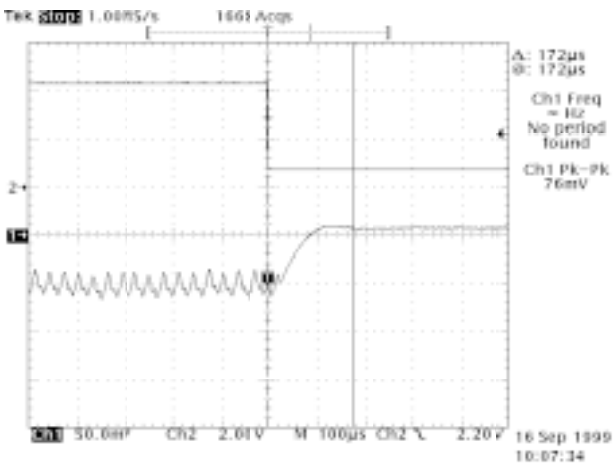

Switching to Linear

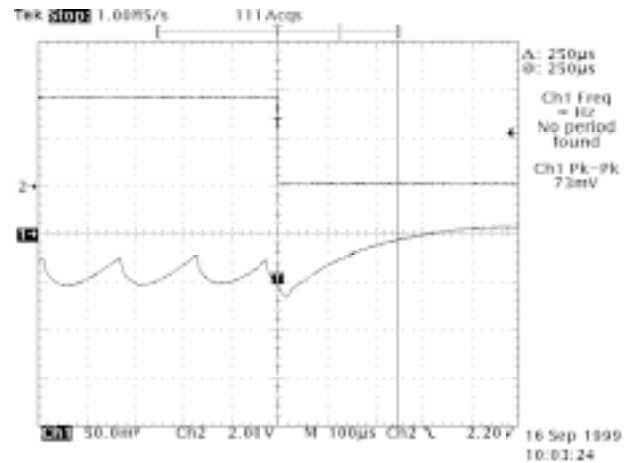

Switching to Linear

APPLICATION INFORMATION (CONT.)

$V_{IN} = 5\text{ V}$ $I_{OUT} = 100\text{ mA}$

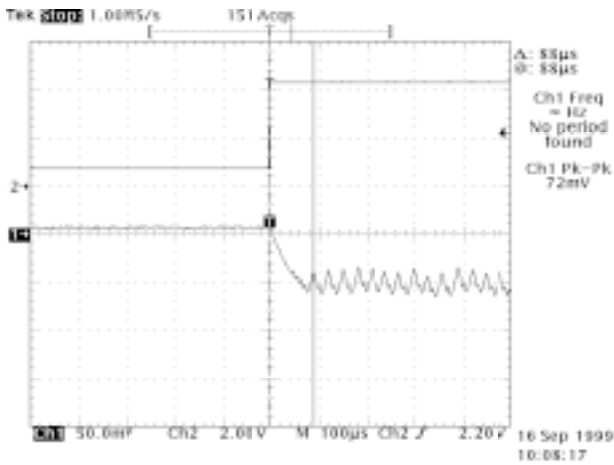

Switching to Buck

$V_{IN} = 3.2\text{ V}$ $I_{OUT} = 100\text{ mA}$

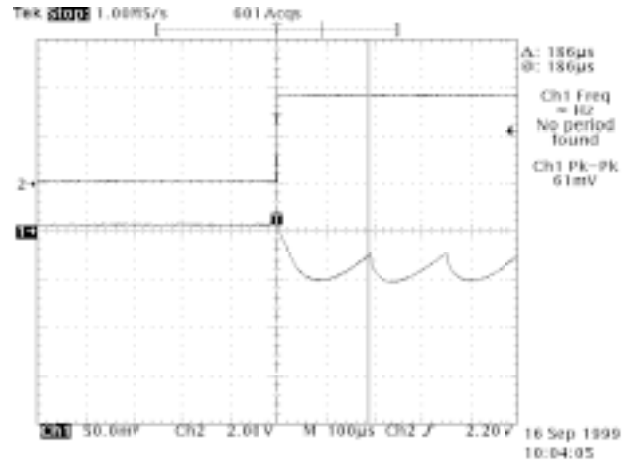

Switching to Buck

Characteristics of this application under lighter loads but similar supply range are shown below.

$V_{IN} = 5\text{ V}$ $I_{OUT} = 20\text{ mA}$

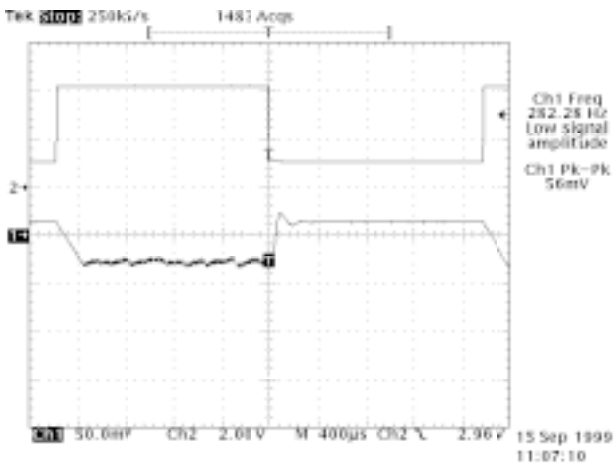

Full Cycle

$V_{IN} = 3.2\text{ V}$ $I_{OUT} = 20\text{ mA}$

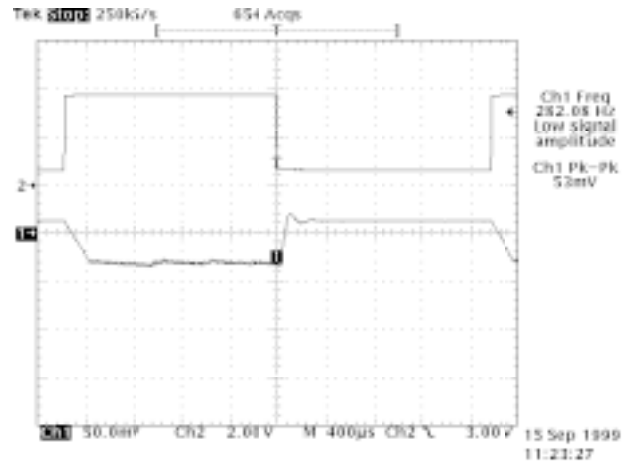

Full Cycle

In conclusion, the ability to provide a clean signal during transmission/reception can be done with linear regulators in a predictable way, the novelty comes in considering the Buck and Linear concept which has the advantage of high efficiency while not compromising the linear regulator's low noise characteristics.

The overall effect being longer battery life while maintaining low RF interference in a wireless system.

NOTES

PACKAGE OUTLINE

SOT23L-6

Dimensions are shown in millimeters
Tolerance: x.x ± 0.2 mm (unless otherwise specified)

Marking Information

Part Number	Marking
TK65418	418
*TK65419	419
*TK65420	420
TK65421	421
*TK65422	422
*TK65423	423
TK65424	424
TK65425	425
*TK65426	426
TK65427	427
*TK65428	428
*TK65429	429
TK65430	430
*TK65431	431
*TK65432	432
TK65433	433

* These voltages available upon request



Toko America, Inc. Headquarters
 1250 Feehanville Drive, Mount Prospect, Illinois 60056
 Tel: (847) 297-0070 Fax: (847) 699-7864

TOKO AMERICA REGIONAL OFFICES

Midwest Regional Office
 Toko America, Inc.
 1250 Feehanville Drive
 Mount Prospect, IL 60056
 Tel: (847) 297-0070
 Fax: (847) 699-7864

Western Regional Office
 Toko America, Inc.
 2480 North First Street, Suite 260
 San Jose, CA 95131
 Tel: (408) 432-8281
 Fax: (408) 943-9790

Eastern Regional Office
 Toko America, Inc.
 107 Mill Plain Road
 Danbury, CT 06811
 Tel: (203) 748-6871
 Fax: (203) 797-1223

Semiconductor Technical Support
 Toko Design Center
 4755 Forge Road
 Colorado Springs, CO 80907
 Tel: (719) 528-2200
 Fax: (719) 528-2375

Visit our Internet site at <http://www.tokoam.com>

The information furnished by TOKO, Inc. is believed to be accurate and reliable. However, TOKO reserves the right to make changes or improvements in the design, specification or manufacture of its products without further notice. TOKO does not assume any liability arising from the application or use of any product or circuit described herein, nor for any infringements of patents or other rights of third parties which may result from the use of its products. No license is granted by implication or otherwise under any patent or patent rights of TOKO, Inc.