

DATA SHEET

NOTICE:

SEE ATTACHED ERRATA WHICH FOLLOWS THIS DOCUMENT FOR INFORMATION
REGARDING CHANGED SPECIFICATIONS

PDI1394L21

1394 full duplex AV link layer controller

Preliminary specification
Supersedes data of 1999 Mar 30

1999 Aug 06

1394 full duplex AV link layer controller

PDI1394L21

1.0 FEATURES

- IEEE 1394–1995 Standard Link Layer Controller
- Hardware Support for the IEC61883 International Standard of Digital Interface for Consumer Electronics
- Interface to any IEEE 1394–1995 Physical Layer Interface
- 5V Tolerant I/Os
- Single 3.3V supply voltage
- Full-duplex isochronous operation
- Operates with 400/200/100 Mbps physical layer devices
- Dual 4K Byte FIFOs for isochronous data
- Supports single capacitor isolation mode and IEEE 1394–1995, Annex J. isolation
- 4-field deep SYT buffer added to enhance real-time isochronous synchronization using the AVFSYNC pin
- Generates its own AV port clocks under software control. Select one of three frequencies: 24.576, 12.288, or 6.144 MHz

2.0 DESCRIPTION

The PDI1394L21, Philips Semiconductors Full Duplex 1394 Audio/Video (AV) Link Layer Controller, is an IEEE 1394–1995 compliant link layer controller featuring 2 embedded AV layer interfaces. The AV layers are designed to pack and un-pack application data packets for transmission over the IEEE 1394 bus using isochronous data transfers. Because of its full duplex architecture, the PDI1394L21 is capable of receiving and transmitting isochronous data during the same bus cycle. Two 8 bit AV ports, each with its own buffer (FIFO), receive and output isochronous data for transmission and reception of bus packets. Each port can be configured to receive or transmit, however, the other port always performs the opposite function. Half duplex operation is also permitted.

The application data is packetized according to the IEC 61883 International Standard of Interface for Consumer Electronic Audio/Video Equipment. Both AV layer interfaces are byte-wide ports capable of accommodating various MPEG–2 and DVC codecs. An 80C51 compatible byte-wide host interface is provided for internal register configuration as well as performing asynchronous data transfers.

The PDI1394L21 is powered by a single 3.3V power supply and the inputs and outputs are 5V tolerant. It is available in the LQFP100 and TQFP100 packages.

3.0 QUICK REFERENCE DATA

GND = 0V; T_{amb} = 25°C

SYMBOL	PARAMETER	CONDITIONS	MIN	TYP	MAX	UNIT
V _{DD}	Functional supply voltage range		3.0	3.3	3.6	V
I _{DD}	Supply current @ V _{DD} = 3.3V	Operating		75		mA
SCLK	Device clock		49.147	49.152	49.157	MHz

4.0 ORDERING INFORMATION

PACKAGES	TEMPERATURE RANGE	OUTSIDE NORTH AMERICA	NORTH AMERICA	PKG. DWG. #
100-pin plastic LQFP100	0°C to +70°C	PDI1394L21BE	PDI1394L21BE	SOT407 AB15
100-pin plastic TQFP100	0°C to +70°C	PDI1394L21BP	PDI1394L21BP	SOT386 BB2

NOTE:

This datasheet is subject to change.
Please visit our internet website www.semiconductors.philips.com/1394 for latest changes.

1394 full duplex AV link layer controller

PDI1394L21

5.0 PIN CONFIGURATION

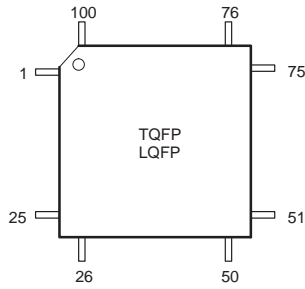

Pin	Function	Pin	Function	Pin	Function
1	HIF D7	35	PHY D6*	69	AV1 D1
2	HIF D6	36	PHY D5*	70	AV1 D2
3	HIF D5	37	PHY D4*	71	AV1 D3
4	HIF D4	38	GND	72	V _{DD}
5	GND	39	V _{DD}	73	GND
6	V _{DD}	40	PHY D3*	74	AV1 D4
7	HIF D3	41	PHY D2*	75	AV1 D5
8	HIF D2	42	PHY D1*	76	AV1 D6
9	HIF D1	43	PHY D0*	77	AV1 D7
10	HIF D0	44	GND	78	V _{DD}
11	CLK25	45	V _{DD}	79	GND
12	GND	46	PHY CTL1*	80	AV2ERR1
13	V _{DD}	47	PHY CTL0*	81	AV2ERR0
14	HIF A8	48	ISO_N	82	AV2ENDPCK
15	HIF A7	49	V _{DD}	83	AV2SYNC
16	HIF A6	50	GND	84	AV2CLK
17	HIF A5	51	N/C	85	AV2FSYNC
18	HIF A4	52	AV1ERR1	86	AV2VALID
19	HIF A3	53	AV1ERR0	87	GND
20	HIF A2	54	LREQ*	88	V _{DD}
21	HIF A1	55	SCLK	89	AV2 D0
22	HIF A0	56	AV1ENDPCK	90	AV2 D1
23	GND	57	AV1SYNC	91	AV2 D2
24	V _{DD}	58	AV1CLK	92	AV2 D3
25	HIF CS_N	59	AV1FSYNC	93	GND
26	HIF WR_N	60	AV1ENKEY	94	V _{DD}
27	HIF RD_N	61	AV1VALID	95	AV2D4
28	HIF INT_N	62	N/C	96	AV2 D5
29	RESET_N	63	GND	97	AV2 D6
30	CYCLE IN	64	V _{DD}	98	AV2 D7
31	GND	65	RESESRVED	99	AV2ENKEY
32	V _{DD}	66	RESERVED	100	N/C
33	CYCLE OUT	67	RESERVED		
34	PHY D7*	68	AV1 D0		

* INDICATES PIN EQUIPPED WITH INTERNAL BUS HOLD CIRCUIT ACTIVATED BY THE STATE OF THE ISO_N PIN.

SV00877

1394 full duplex AV link layer controller

PDI1394L21

6.0 FUNCTIONAL DIAGRAM

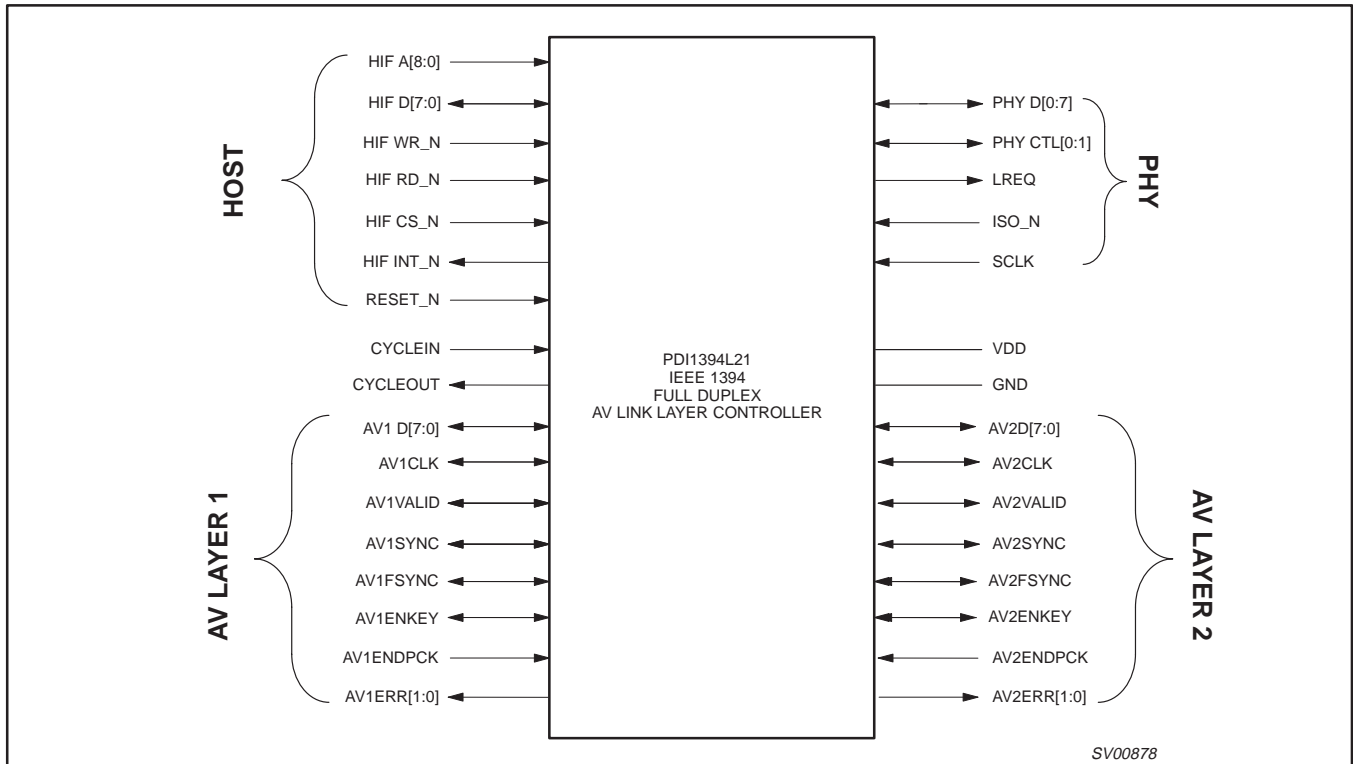

7.0 INTERNAL BLOCK DIAGRAM

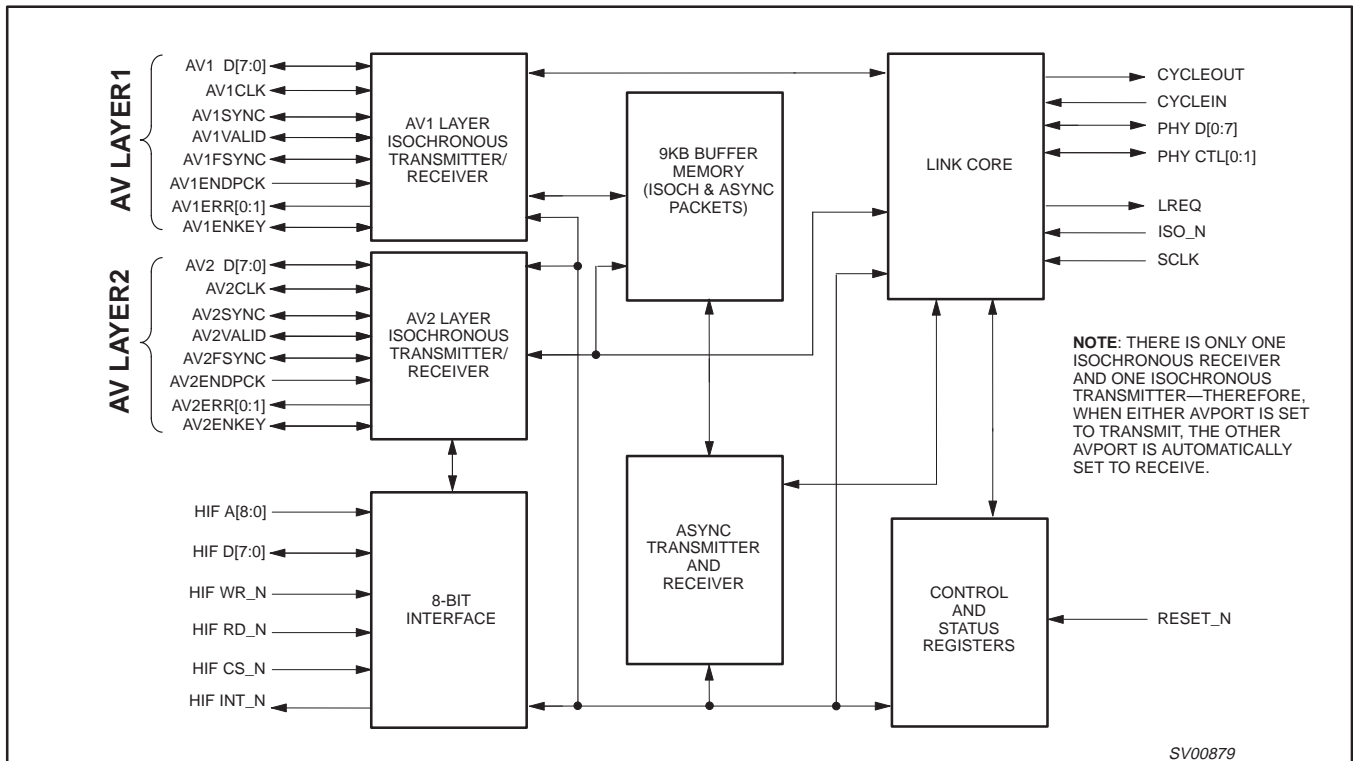

1394 full duplex AV link layer controller

PDI1394L21

8.0 APPLICATION DIAGRAM

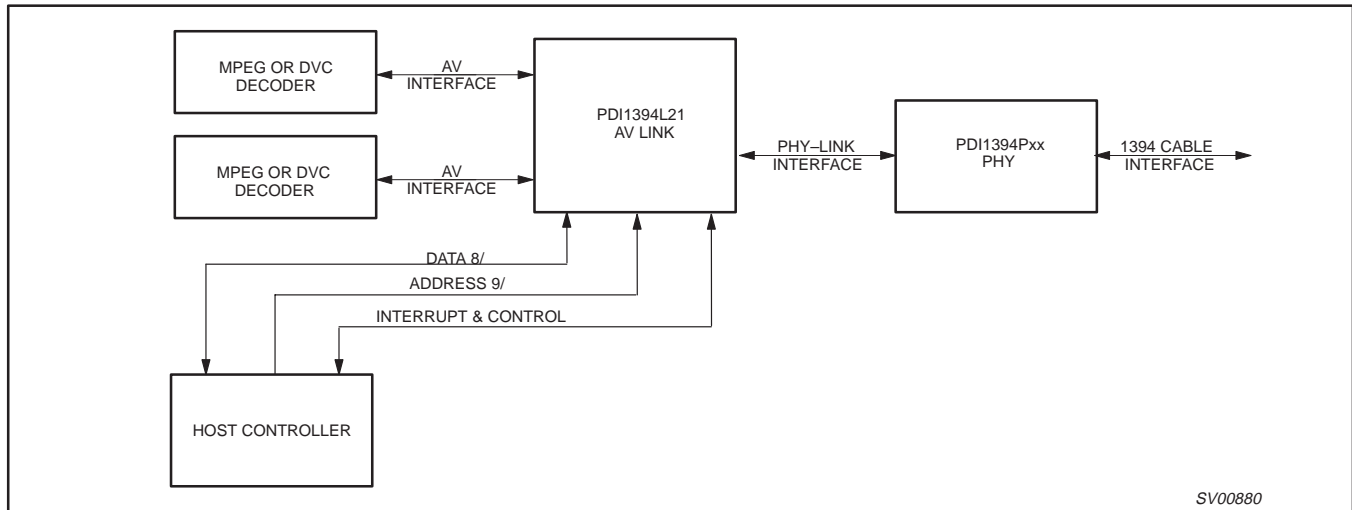

9.0 PIN DESCRIPTION

9.1 Host Interface

PIN No.	PIN SYMBOL	I/O	NAME AND FUNCTION
1, 2, 3, 4, 7, 8, 9, 10	HIF D[7:0]	I/O	Host Interface Data 7 (MSB) through 0. Byte wide data path to internal registers.
5, 12, 23, 31, 38, 44, 50, 63, 73, 79, 87, 93	GND		Ground reference
6, 13, 24, 32, 39, 45, 49, 64, 72, 78, 88, 94	V _{DD}		3.3V ± 0.3V power supply
14, 15, 16, 17, 18, 19, 20, 21, 22	HIF A[8:0]	I	Host Interface Address 0 through 8. Provides the host with a byte wide interface to internal registers. See description of Host Interface for addressing rules.
25	HIF CS_N	I	Chip Select (active LOW). Host bus control signal to enable access to the FIFO and control and status registers.
26	HIF WR_N	I	Write enable. When asserted (LOW) in conjunction with HIF CS_N, a write to the PDI1394L21 internal registers is requested. (NOTE: HIF WR_N and HIF RD_N : if these are both LOW in conjunction with HIF CS_N, then a write cycle takes place. This can be used to connect CPUs that use R/W_N line rather than separate RD_N and WR_N lines. In that case, connect the R/W_N line to the HIF WR_N and tie HIF RD_N LOW.)
27	HIF RD_N	I	Read enable. When asserted (LOW) in conjunction with HIF CS_N, a read of the PDI1394L21 internal registers is requested.
28	HIF INT_N	O	Interrupt (active LOW). Indicates a interrupt internal to the PDI1394L21. Read the General Interrupt Register for more information. This pin is open drain and requires a 1KΩ pull-up resistor.
29	RESET_N	I	Reset (active LOW). The asynchronous master reset to the PDI1394L21.

1394 full duplex AV link layer controller

PDI1394L21

9.2 AV Interface 1

NOTE: This AV interface may be configured to transmit or receive according to the condition of “DIRAV1” bit in GLOBCSR register (0X018)—default is transmit.

PIN No.	PIN SYMBOL	I/O	NAME AND FUNCTION
77, 76, 75, 74, 71, 70, 69, 68	AV1 D[7:0]	I/O	Audio/Video Data 7 (MSB) through 0. Byte-wide interface to the AV layer 1.
58	AV1CLK	I/O	External application clock. Rising edge active. This pin can be programmed to output the application clock. Depending on the configuration of AV Port 1 as transmitter or receiver, the output enable is located in the ITXPCTL register (address 0x020) or IRXPCTL register (address 0x040).
57	AV1SYNC	I/O	Start of packet indicator; should only be used when AV1VALID is active.
59	AV1FSYNC	I/O	Programmable frame sync, can be set to input. Frame sync input used for Digital Video (DV). The signal is time stamped and transmitted in the SYT field of ITXHQ2. Frame sync output. Signal is derived from SYT field of IRXHQ2.
56	AV1ENDPCK	I	End of application packet indication from data source. Required only if input packet is not multiple of 4 bytes. It can be tied LOW for data packets that are 4*N in size.
60	AV1ENKEY	I/O	Encryption key state. Indicates state “1” or “0” of encryption key which matches present port data during receive mode. Used to input key state during transmit mode.
61	AV1VALID	I/O	Indicates data on AV1 D [7:0] is valid.
53	AV1ERR0	O	CRC error, indicates bus packet containing AV1 D [7:0] had a CRC error, the current AV packet is unreliable.
52	AV1ERR1	O	Sequence Error. Indicates at least one source packet was lost before the current AV1 D [7:0] data.

9.3 AV Interface 2

NOTE: This AV interface may be configured to transmit or receive according to the condition of “DIRAV1” bit in GLOBCSR register—default is receive.

PIN No.	PIN SYMBOL	I/O	NAME AND FUNCTION
98, 97, 96, 95, 92, 91, 90, 89	AV2 D[7:0]	I/O	Audio/Video Data 7 (MSB) through 0. Byte-wide interface to the AV layer 2.
84	AV2CLK	I/O	External application clock. Rising edge active. This pin can be programmed to output the application clock. Depending on the configuration of AV Port 2 as transmitter or receiver, the output enable is located in the ITXPCTL register (address 0x020) or IRXPCTL register (address 0x040).
83	AV2SYNC	I/O	Start of packet indicator; should only be used when AV2VALID is active.
85	AV2FSYNC	I/O	Programmable frame sync, can be set to input or output. Frame sync input used for Digital Video (DV). The signal is time stamped and transmitted in the SYT field of ITXHQ2. Frame sync output. Signal is derived from SYT field of IRXHQ2.
82	AV2ENDPCK	I	End of application packet indication from data source. Required only if input packet is not multiple of 4 bytes. It can be tied LOW for data packets that are 4*N in size.
86	AV2VALID	I/O	Indicates data on AV2 D [7:0] is valid.
81	AV2ERR0	O	CRC error, indicates bus packet containing AV2 D [7:0] had a CRC error, the current AV packet is unreliable.
80	AV2ERR1	O	Sequence Error. Indicates at least one source packet was lost before the current AV2 D [7:0] data.
99	AV2ENKEY	I/O	Encryption key state. Indicates state “1” or “0” of encryption key which matches present port data during receive mode. Used to input key state during transmit mode.

9.4 Phy Interface

PIN No.	PIN SYMBOL	I/O	NAME AND FUNCTION
43, 42, 41, 40, 37, 36, 35, 34	PHY D[0:7]	I/O	Data 0 (MSB) through 7 (NOTE: To preserve compatibility to the specified Link-Phy interface of the IEEE 1394–1995 standard, Annex J, bit 0 is the most significant bit). Data is expected on PHY D[0:1] for 100Mb/s, PHY D[0:3] for 200Mb/s, and PHY D[0:7] for 400Mb/s. See IEEE 1394–1995 standard, Annex J for more information.
47, 46	PHY CTL[0:1]	I/O	Control Lines between Link and Phy. See 1394 Specification for more information.
48	ISO_N	I	Isolation mode. This pin is asserted (LOW) when an Annex J type isolation barrier is used. See IEEE 1394–1995 Annex J. for more information. When tied HIGH, this pin enables internal bushold circuitry on the affected PHY interface pins (see below). Active bushold circuits allow either the direct connection to PHY pins or the use of the single capacitor isolation mode.
54	LREQ	O	Link Request. Bus request to access the PHY. See IEEE 1394–1995 standard, Annex J for more information. (Used to request arbitration or read/write PHY registers).
55	SCLK	I	System clock. 49.152MHz input from the PHY (the PHY-LINK interface operates at this frequency).

1394 full duplex AV link layer controller

PDI1394L21

9.4.1 Bushold and Link/PHY single capacitor galvanic isolation

9.4.1.1 Bushold

The PDI1394L21 uses an internal bushold circuit on each of the indicated pins to keep these CMOS inputs from “floating” while being driven by a 3-States device or input coupling capacitor.

Unterminated high impedance inputs react to ambient electrical noise which cause internal oscillation and excess power supply current draw.

The following pins have bushold circuitry enabled when the ISO_N pin is in the logic “1” state:

Pin No.	Name	Function
47	PHYCTL0	PHY control line 0
46	PHYCTL1	PHY control line 1
54	LREQ	Link request line
43	PHYD0	PHY data bus bit 0
42	PHYD1	PHY data bus bit 1
41	PHYD2	PHY data bus bit 2
40	PHYD3	PHY data bus bit 3
37	PHYD4	PHY data bus bit 4
36	PHYD5	PHY data bus bit 5
35	PHYD6	PHY data bus bit 6
34	PHYD7	PHY data bus bit 7

Philips bushold circuitry is designed to provide a high resistance pull-up or pull-down on the input pin. This high resistance is easily overcome by the driving device when its state is switched. Figure 1 shows a typical bushold circuit applied to a CMOS input stage. Two weak MOS transistors are connected to the input. An inverter is also connected to the input pin and supplies gate drive to both transistors. When the input is LOW, the inverter output drives the lower MOS transistor and turns it on. This re-enforces the LOW on the input pin. If the logic device which normally drives the input pin were to be 3-States, the input pin would remain “pulled-down” by the weak MOS transistor. If the driving logic device drives the input pin

HIGH, the inverter will turn the upper MOS transistor on, re-enforcing the HIGH on the input pin. If the driving logic device is then 3-States, the upper MOS transistor will weakly hold the input pin HIGH.

The PHY’s outputs can be 3-States and single capacitor isolation can be used with the Link; both situations will allow the Link inputs to float. With bushold circuitry enabled, these pins are provided with dc paths to ground, and power by means of the bushold transistors; this arrangement keeps the inputs in known logical states.

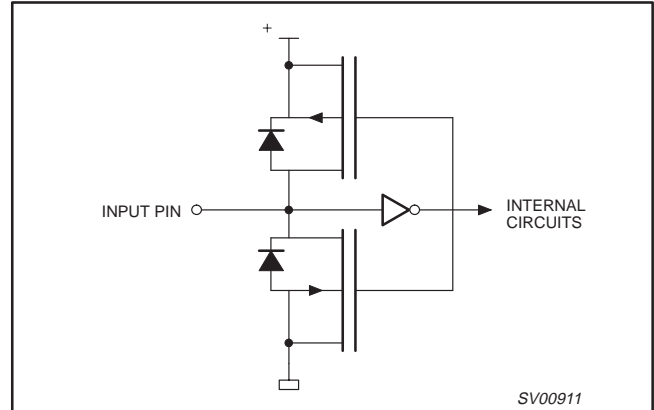

Figure 1. Bushold circuit

9.4.1.2 Single capacitor isolation

The circuit example (Figure 2) shows the connections required to implement basic single capacitor Link/PHY isolation.

NOTE: The isolation enablement pins on both devices are in their “1” states, activating the bushold circuits on each part. The bushold circuits provide local dc ground references to each side of the isolating/coupling capacitors. Also note that ground isolation/signal-coupling must be provided in the form of a parallel combination of resistance and capacitance as indicated in IEEE 1394–1995.

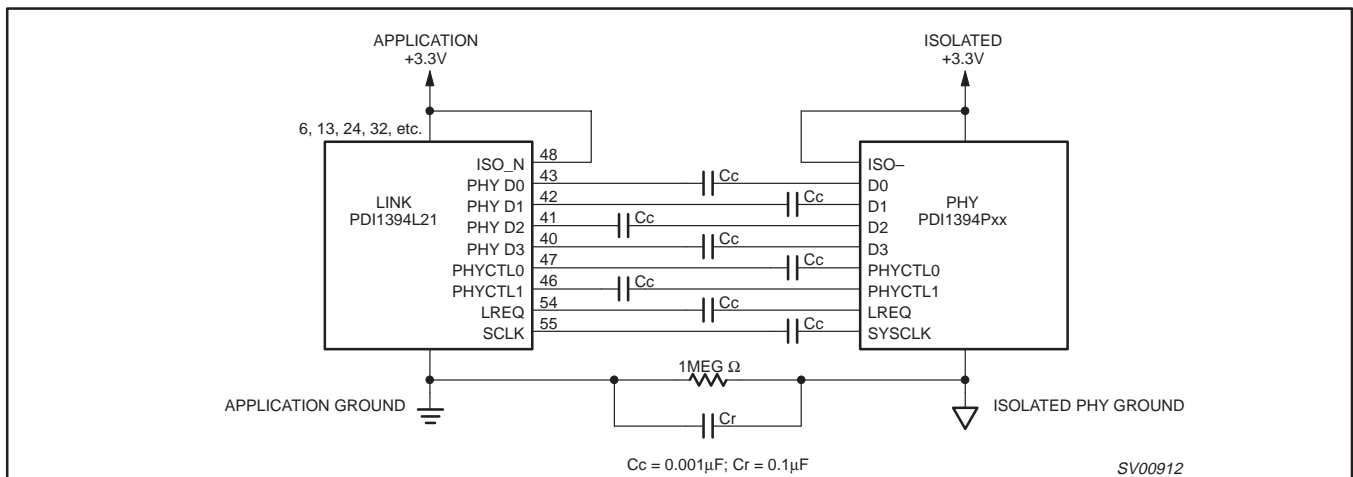

Figure 2. Single capacitor Link/PHY isolation

1394 full duplex AV link layer controller

PDI1394L21

9.5 Other Pins

PIN No.	PIN SYMBOL	I/O	NAME AND FUNCTION
65, 66, 67	RESERVED	NA	These pins are reserved for factory testing. For normal operation they should be connected to ground.
51, 62, 100	N/C	NA	These pins should not be connected or terminated.
30	CYCLEIN	I	Provides the capability to supply an external cycle timer signal for the beginning of 1394 bus cycles.
33	CYCLEOUT	O	Reproduces the 8kHz cycle clock of the cycle master.
11	CLK25	O	Auxiliary clock, value is SCLK/2 (usually 24.576 MHz)

10.0 RECOMMENDED OPERATING CONDITIONS

SYMBOL	PARAMETER	CONDITIONS	LIMITS		UNIT
			MIN.	MAX.	
V _{CC}	DC supply voltage		3.0	3.6	V
V _I	Input voltage		0	5	V
V _{IH}	High-level input voltage		2.0		V
V _{IL}	Low-level input voltage			0.8	V
I _{OH}	High-level output current			8	mA
I _{OL}	Low-level output current			-8	mA
dT/dV	Input transition rise or fall time		0	20	ns/V
T _{amb}	Operating ambient temperature range		0	+70	°C
SCLK	System clock		49.147	49.157	MHz
AVCLK	AV interface clock		0	24	MHz
t _r	Input rise time			10	ns
t _f	input fall time			10	ns

11.0 ABSOLUTE MAXIMUM RATINGS^{1, 2}

In accordance with the Absolute Maximum Rating System (IEC 134). Voltages are referenced to GND (ground = 0V).

SYMBOL	PARAMETER	CONDITIONS	LIMITS		UNIT
			MIN	MAX	
V _{DD}	DC supply voltage		-0.5	+4.6	V
I _{IK}	DC input diode current		-	-50	mA
V _I	DC input voltage		-0.5	+5.5	V
I _{OK}	DC output diode current		-	±50	mA
V _O	DC output voltage		-0.5	V _{DD} +0.5	V
I _O	DC output source or sink current		-	±50	mA
I _{GND} , I _{CC}	DC V _{CC} or GND current		-	±150	mA
T _{stg}	Storage temperature range		-60	150	°C
T _{amb}	Operating ambient temperature		0	70	°C
P _{tot}	Power dissipation per package			0.6	W

NOTES:

- Stresses beyond those listed may cause permanent damage to the device. These are stress ratings only and functional operation of the device at these or any other conditions beyond those indicated under "recommended operating conditions" is not implied. Exposure to absolute-maximum-rated conditions for extended periods may affect device reliability.
- The performance capability of a high-performance integrated circuit in conjunction with its thermal environment can create junction temperatures which are detrimental to reliability. The maximum junction temperature of this integrated circuit should not exceed 150°C.

1394 full duplex AV link layer controller

PDI1394L21

11.1 Buffer Memory Sizes

BUFFER MEMORY	SIZE (Quadlets)
Asynchronous Receive Response FIFO	64
Asynchronous Receive Request FIFO	128
Asynchronous Transmit Response FIFO	64
Asynchronous Transmit Request FIFO	64
Isochronous (AV) Transmit Buffer	1024
Isochronous (AV) Receive Buffer	1024

12.0 FUNCTIONAL DESCRIPTION

12.1 Overview

The PDI1394L21 is an IEEE 1394–1995 compliant link layer controller. It provides a direct interface between a 1394 bus and various MPEG–2 and DVC codecs. Via this interface, the AV Link maps and unmaps these AV datastreams from these codecs onto 1394 isochronous bus packets. The AV Link also provides an 8051 compatible microcontroller interface for an attached host controller. Through the host interface port, the host controller can configure the AV layer for transmission or reception of AV datastreams. The host interface port also allows the host controller to transmit and receive 1394 asynchronous data packets.

12.2 AV interface and AV layer

The AV interface and AV layer allow AV packets to be transmitted from one node to another. The AV transmitter and receiver within the AV layer perform all the functions required to pack and unpack AV packet data for transfer over a 1394 network. Once the AV layer is properly configured for operation, no further host controller service should be required. The operation of the AV layer is full-duplex, i.e., the AV layer can receive and transmit AV packets at the same time.

12.2.1 The AV Interface

The AV Link provides an 8 bit data path to the AV layer. The 8 bit data path is designed with associated clock and control signals to be compatible with various MPEG–2 and DVC codecs.

The AV interface port buffer, if so programmed, can time stamp incoming AV packets. The AV packet data is stored in the embedded memory buffer, along with its time stamp information. After the AV packet has been written into the AV layer, the AV layer creates an isochronous bus packet with the appropriate CIP header. The bus packet along with the CIP header is transferred over the appropriate isochronous channel/packet. The size and configuration of isochronous data packet payload transmitted is determined by the AV layer's configuration registers accessible through the host interface.

The AV interface port waits for the assertion for AVxVALID and AVxSYNC. **Note:** Do not assert AVxSYNC without AVxVALID. AVxSYNC is aligned with the rising edge of AVxCLK and the first byte of data on AVxDATA[7:0]. The duration of AVxSYNC is one AVxCLK cycle. AVxSYNC signals the AV layer that the transfer of an AV packet has begun. At the time the AVxSYNC is asserted, the AV layer creates a new time stamp in the buffer memory. (This only happens if so configured. The DVC format does not use these time stamps). The time stamp is then transmitted as part of the source packet header. This allows the AV receiver to provide the AV packet for output at the appropriate time. Only one AVSYNC pulse is allowed per application packet; if additional sync pulses are presented before the full packet is inputted, a new packet will be started and the previously inputted packet data will be discarded (and not transmitted) in conjunction with the input error interrupt bit (INPERR, bit 3 of register 0x02C) being set to flag the error.

When the DV video is enabled (via the format code of the CIP header), the frame synchronization signal AVxFSYNC is time stamped and placed in the SYT field. The default timestamp value is 3 cycle times (duration of 125µs each) in the future and is transmitted in the SYT field of the current CIP header; this value is programmable from 2 to 4 cycle times (see section 13.2.1). On the receiver side, when the SYT stamp matches the cycle timer register, a pulse is generated on the AVxFSYNC output. The timing for AVxFSYNC is independent of AVxCLK.

12.2.2 IEC 61883 International Standard

The PDI1394L21 is specifically designed to support the IEC61883 International Standard of Digital Interface for Consumer Electronic Audio/Video Equipment. The IEC specification defines a scheme for mapping various types of AV datastreams onto 1394 isochronous data packets. The standard also defines a software protocol for managing isochronous connections in a 1394 bus called Connection Management Protocol (CMP). It also provides a framework for transfer of functional commands, called Function Control Protocol (FCP).

12.2.3 CIP Headers

A feature of the IEC61883 International Standard is the definition of Common Isochronous Packet (CIP) headers. These CIP headers contain information about the source and type of datastream mapped onto the isochronous packets.

The AV Layer supports the use of CIP headers. CIP headers are added to transmitted isochronous data packets at the AV data source. When receiving isochronous data packets, the AV layer automatically analyzes their CIP headers. The analysis of the CIP headers determines the method the AV layer uses to unpack the AV data from the isochronous data packets.

The information contained in the CIP headers is accessible via registers in the host interface.

(See IEC61883 International Standard of Digital Interface for Consumer Electronic Audio/Video Equipment for more details on CIP headers).

1394 full duplex AV link layer controller

PDI1394L21

12.3 The host interface

The host interface allows an 8 bit CPU to access all registers and the asynchronous packet queues. It is specifically designed for an 8051 microcontroller but can also be used with other CPUs. There are 64 register addresses (for quadlet wide registers). To access bytes rather than quadlets the address spaces is 256 bytes, requiring 8 address lines.

The use of an 8 bit interface introduces an inherent problem that must be solved: register fields can be more than 8 bits wide and be used (control) or changed (status) at every internal clock tick. If such a field is accessed through an 8 bit interface it requires more than one read or write cycle, and the value should not change in between to maintain consistency. To overcome this problem accesses to the chip's internal register space are always 32 bits, and the host interface must act as a converter between the internal 32 bit accesses and external 8 bit accesses. This is where the shadow registers are used.

12.3.1 Read accesses

To read an internal register the host interface can make a snapshot (copy) of that specific register which is then made available to the CPU 8 bits at a time. The register that holds the snapshot copy of the real register value inside the host interface is called the **read shadow register**. During a read cycle address lines HIF A0 and HIF A1 are used to select which of the 4 bytes currently stored in the **read shadow register** is output onto the CPU data bus. This selection is done by combinatorial logic only, enabling external hardware to toggle these lines through values 0 to 3 while keeping the chip in a read access mode to get all 4 bytes out very fast (in a single extended read cycle), for example into an external quadlet register.

This solution requires a control line to direct the host interface to make a snapshot of an internal register when needed, as well as the internal address of the target register. The register address is connected to input address lines HIF A2..HIF A7, and the update control line to input address line HIF A8. To let the host interface take a new snapshot the target address must be presented on HIF A2..HIF A7 and HIF A8 must be raised while executing a read access. The new value will be stored in the **read shadow register** and the selected byte (HIF A0, HIF A1) appears on the output.

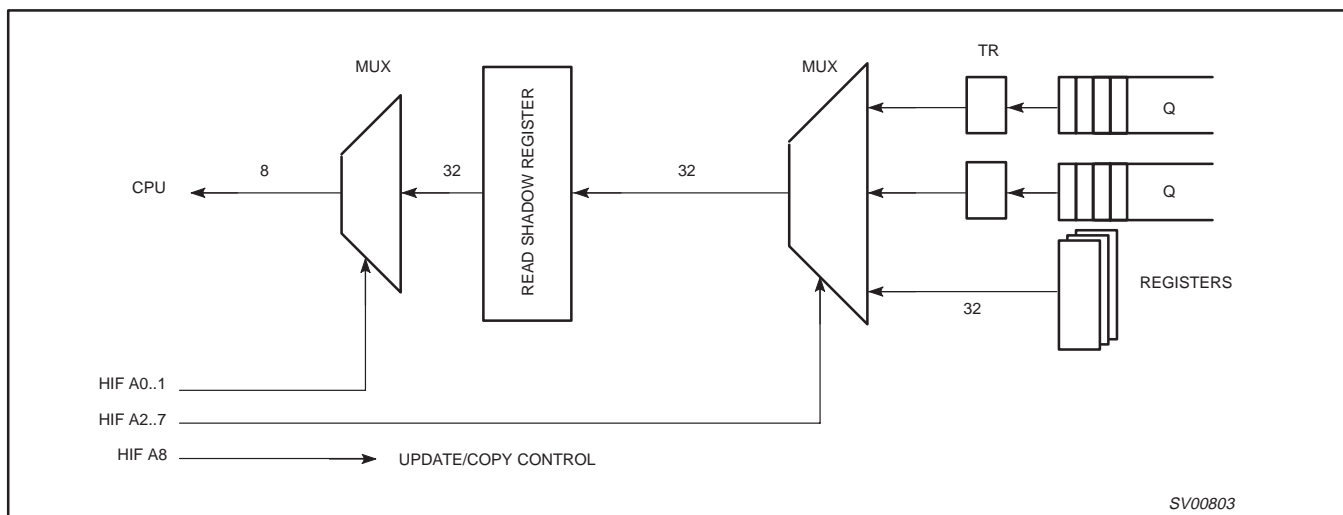

NOTES:

1. It is not required to read all 4 bytes of a register before reading another register. For example, if only byte 2 of register 0x54 is required a read of byte address $0x100 + (0 \times 54) + 2 = 0x156$ is sufficient.
2. The update control line does not necessarily have to be connected to the CPU address line HIF A8. This input could also be controlled by other means, for example a combinatorial circuit that activates the update control line whenever a read access is done for byte 0. This makes the internal updating automatic for quadlet reading.
3. Reading the bytes of the read shadow register can be done in any order and as often as needed.

1394 full duplex AV link layer controller

PDI1394L21

12.3.2 Write accesses

To write to an internal register the host interface must collect the 4 byte values into a 32 bit value and then write the result to the target register in a single clock tick. This requires a register to hold the 32 bit value being compiled until it is ready to be written to the actual target register. This temporary register inside the host interface is called the **write shadow register**. During all write cycles address lines HIF A0 and HIF A1 are used to select which of the 4 bytes of the **write shadow register** is to be written with the value on the CPU data bus. Only one byte can be written in a single write access cycle.

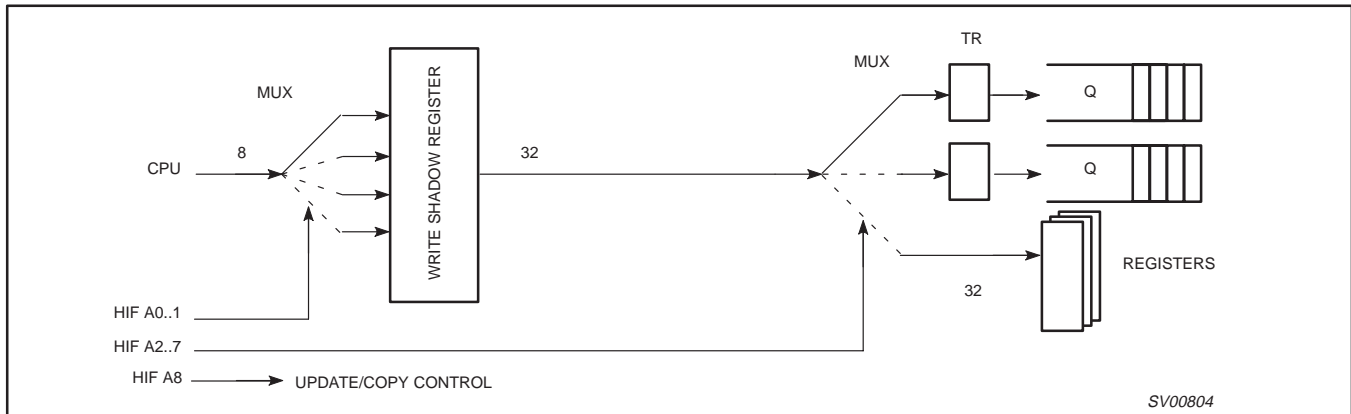

NOTES:

1. It is not required to write all 4 bytes of a register: those bytes that are either reserved (undefined) or don't care do not have to be written in which case they will be assigned the value that was left in the corresponding byte of the **write shadow register** from a previous write access. For example, to acknowledge an interrupt for the isochronous receiver (external address 0x04C), a single byte write to location $0x100+(0x4C)+3 = 0x14F$ is sufficient. The value 256 represents setting HIF A8=1. The host interface cannot directly access the FIFOs, but instead reads from/writes into a transfer register (shown as TR in the Figures above). Data is moved between FIFO and TR by internal logic as soon as possible without CPU intervention.
2. The update control line does not necessarily have to be connected to the CPU address line HIF A8. This input could also be controlled by other means, for example a combinatorial circuit that activates the update control line whenever a write access is done for byte 3. This makes the internal updating automatic for quadlet writing.
3. Writing the bytes of the read shadow register can be done in any order and as often as needed (new writes simply overwrite the old value).

12.3.3 Byte order

The bytes in each quadlet are numbered 0..3 from left (most significant) to right (least significant) as shown in Figure 3. To access a register at internal address N the CPU should use addresses E:

- E = N ; to access the upper 8 bits of the register.
- E = N + 1 ; to access the upper middle 8 bits of the register.
- E = N + 2 ; to access the lower middle 8 bits of the register.
- E = N + 3 ; to access the lower 8 bits of the register.

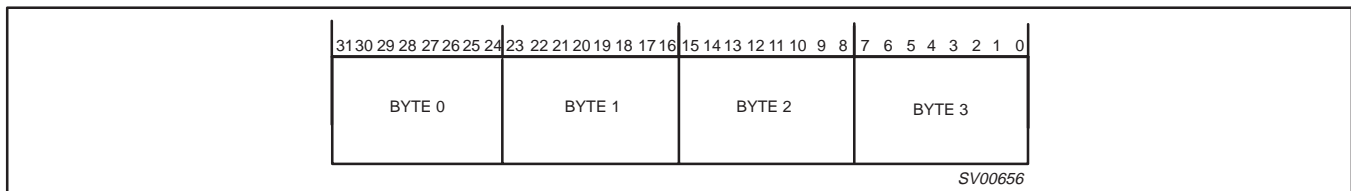

Figure 3. Byte order in quadlets as implemented in the host interface

12.3.4 Accessing the packet queues

Although entire incoming packets are stored in the receiver buffer memory they are not randomly accessible. These buffers act like FIFOs and only the frontmost (oldest) data quadlet entry is accessible for reading. Therefore only one location (register address) is allocated to each of the two receiver queues. Reading this location returns the head entry of the queue, and at the same time removes it from the queue, making the next stored data quadlet accessible.

With the current host interface such a read is in fact a move operation of the data quadlet from the queue to the read shadow register. Once the data is copied into the read shadow register it is no longer available in the queue itself so the CPU should always read all 4 bytes before attempting any other read access (be careful with interrupt handlers for the PDI1394L21!).

1394 full duplex AV link layer controller

PDI1394L21

12.3.5 The CPU bus interface signals

The CPU interface is directly compatible with an 8051 microcontroller. It uses a separate HIF RD_N and HIF WR_N inputs and a HIF CS_N chip select line, all of which are active LOW. There are 9 address inputs (HIF A0..HIF A8) and 8 data in/out lines HIF D0..HIF D7. An open drain HIF INT_N output is used to signal interrupts to the CPU.

The CPU is not required to run at a clock that is synchronous to the 1394 base clock. The control signals will be resampled by the host interface before being used internally.

An access through the host interface starts when HIF CS_N = 0 and either HIF WR_N = 0 or HIF RD_N = 0. Typically the chip select signal is derived from the upper address lines of the CPU (address decode stage), but it could also be connected to a port pin of the CPU to avoid the need for an external address decoder in very simple CPU systems. When both HIF CS_N = 0 and HIF RD_N = 0 the host interface will start a read access cycle, so the cycle is triggered at the falling edge of either HIF CS_N or HIF RD_N, whichever is later.

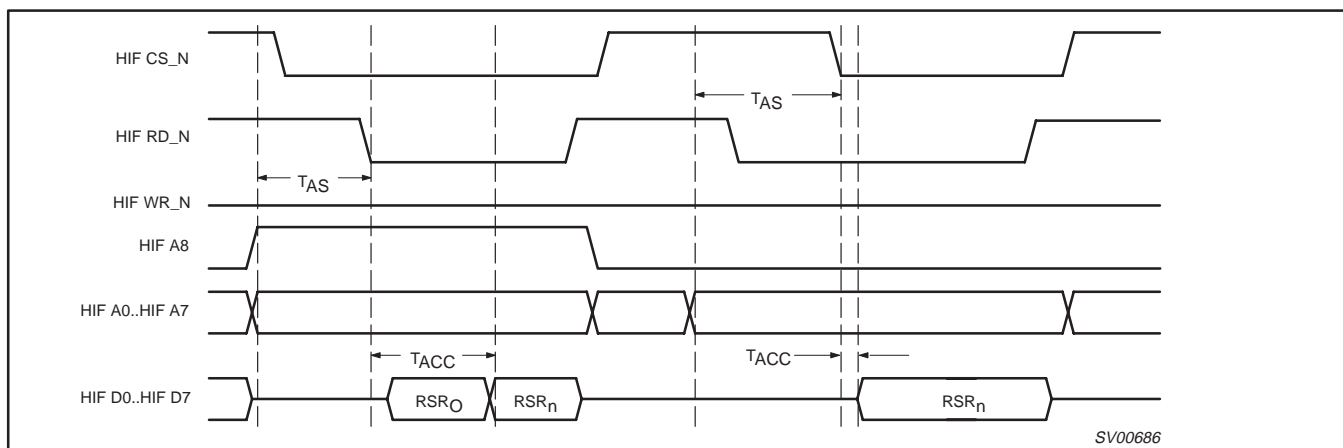

Figure 4. Read cycle signal timing (2 independent read cycles)

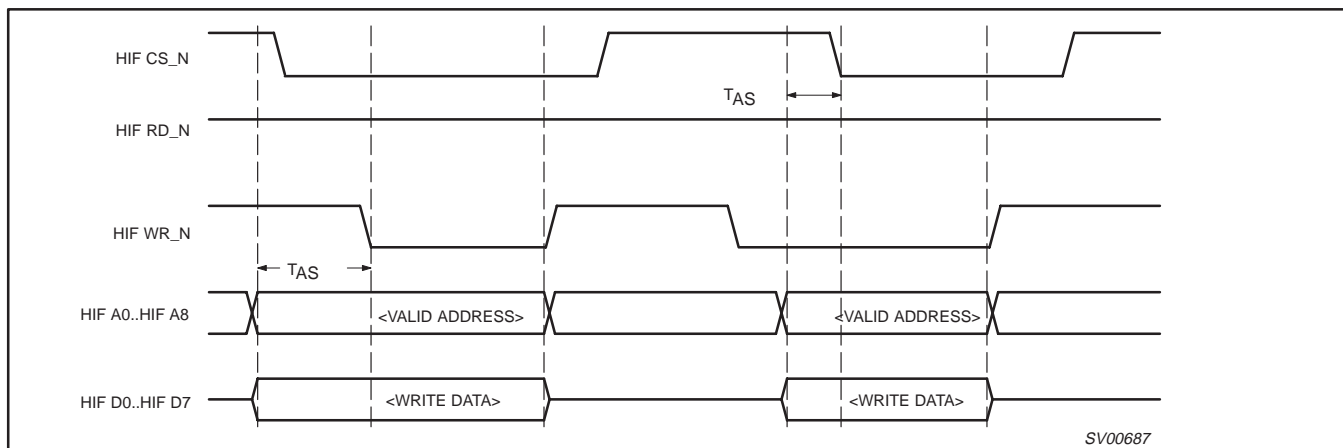

Figure 5. Write cycle signal timing (2 independent write cycles)

12.4 The Asynchronous Packet Interface

The PDI1394L21 provides an interface to asynchronous data packets through the registers in the host interface. The format of the asynchronous packets is specified in the following sections.

12.4.1 Reading an Asynchronous Packet

Upon reception of a packet, the packet data is stored in the appropriate receive FIFO, either the Request or Response FIFO. The location of the packet is indicated by either the RREQQAV or RRSPQAV status bit being set in the Asynchronous Interrupt Acknowledge (ASYINTACK) register. The packet is transferred out of the FIFO by successive reads of the Asynchronous Receive Request (RREQ) or Asynchronous Receive Response (RRSP) register. The end of the packet (the last quadlet) is indicated by either the RREQQLASTQ or RRSPQLASTQ bit set in ASYINTACK. Attempting to read the FIFO when either RREQQAV bit or RRSPQAV bit is set to 0 (in the Asynchronous RX/TX interrupt acknowledge (ASYINTACK) register) will result in a queue read error.

1394 full duplex AV link layer controller

PDI1394L21

12.5 Link Packet Data Formats

The data formats for transmission and reception of data are shown below. The transmit format describes the expected organization for data presented to the link at the asynchronous transmit, physical response, or isochronous transmit FIFO interfaces.

12.5.1 Asynchronous Transmit Packet Formats

These sections describe the formats in which packets need to be delivered to the queues (FIFOs) for transmission. There are four basic formats as follows:

ITEM	FORMAT	USAGE	TRANSACTION CODE (tCode)
1	No-packet data	Quadlet read requests	4
		Quadlet/block write responses	2
2	Quadlet packet	Quadlet write requests	0
		Quadlet read responses	6
		Block read requests	5
3	Block Packet	Block write requests	1
		Block read responses	7
		Lock requests	9
		Lock responses	B _{hex}
4	Unformatted transmit	Concatenated self-ID / PHY packets	E _{hex}

Each packet format uses several fields (see names and descriptions below). More information about these fields (not the format) can be found in the 1394 specification. Grey fields are reserved and should be set to zero values.

12.5.1.1 No-data Transmit

The no-data transmit formats are shown in Figures 6 and 7. The first quadlet contains packet control information. The second and third quadlets contain 16-bit destination ID and either the 48-bit, quadlet aligned destination offset (for requests) or the response code (for responses).

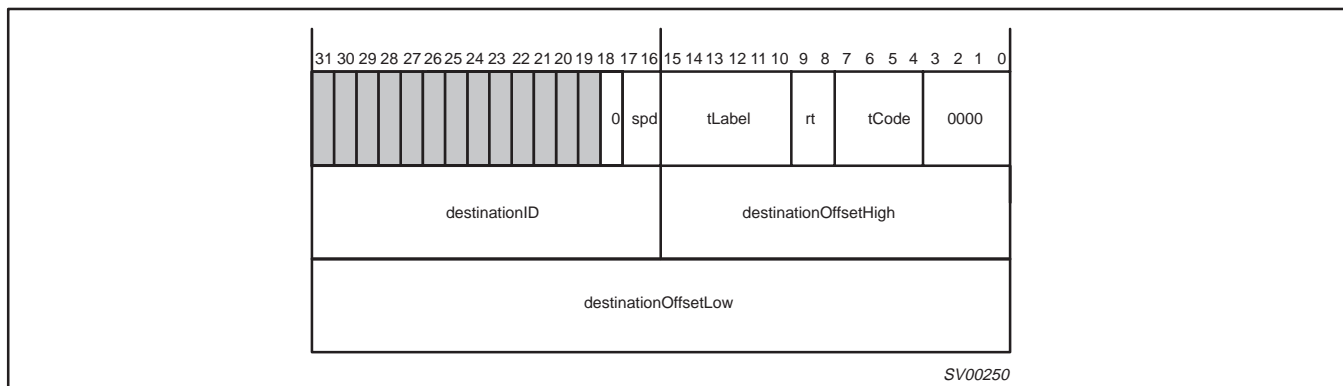

Figure 6. Quadlet Read Request Transmit Format

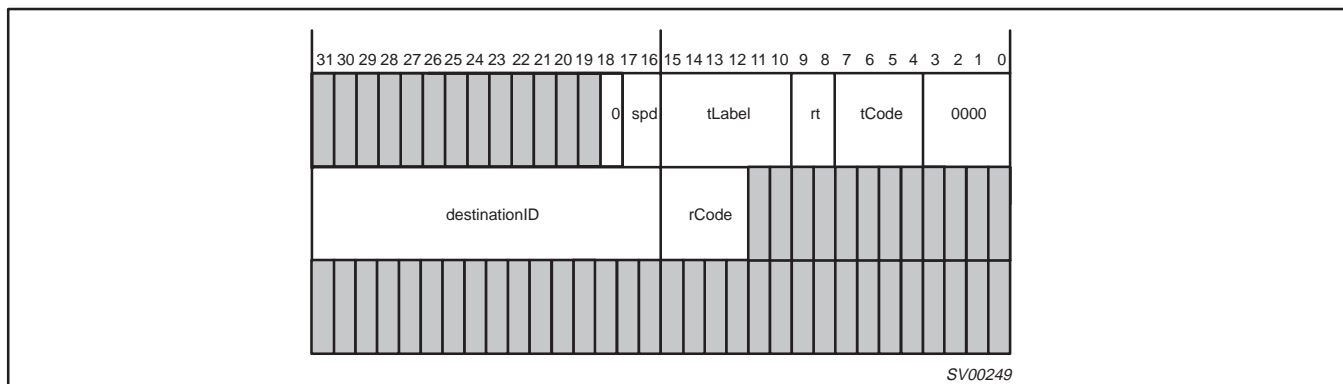

Figure 7. Quadlet/Block Write Response Packet Transmit Format

1394 full duplex AV link layer controller

PDI1394L21

Table 1. No-Data Transmit Format

Field Name	Description																
spd	This field indicates the speed at which this packet is to be sent. 00=100 Mbs, 01=200 Mbs, and 10=400 Mbs. 11 = undefined																
tLabel	This field is the transaction label, which is used to pair up a response packet with its corresponding request packet.																
rt	The retry code for this packet. Supported values are: 00=retry1, and 01=retryX.																
tCode	The transaction code for this packet.																
DestinationID	Contains a node ID value.																
DestinationOffsetHigh DestinationOffsetLow	The concatenation of these two field addresses a quadlet in the destination node's address space.																
rCode	Response code for write response packet. <table border="1" style="margin-left: 20px;"> <thead> <tr> <th>rCode</th> <th>Meaning</th> </tr> </thead> <tbody> <tr> <td>0</td> <td>Node successfully completed requested operation.</td> </tr> <tr> <td>1-3</td> <td>Reserved</td> </tr> <tr> <td>4</td> <td>Resource conflict detected by responding agent. Request may be retried.</td> </tr> <tr> <td>5</td> <td>Hardware error. Data not available.</td> </tr> <tr> <td>6</td> <td>Field within request packet header contains unsupported or invalid value.</td> </tr> <tr> <td>7</td> <td>Address location within specified node not accessible.</td> </tr> <tr> <td>8-Fh</td> <td>Reserved</td> </tr> </tbody> </table>	rCode	Meaning	0	Node successfully completed requested operation.	1-3	Reserved	4	Resource conflict detected by responding agent. Request may be retried.	5	Hardware error. Data not available.	6	Field within request packet header contains unsupported or invalid value.	7	Address location within specified node not accessible.	8-Fh	Reserved
rCode	Meaning																
0	Node successfully completed requested operation.																
1-3	Reserved																
4	Resource conflict detected by responding agent. Request may be retried.																
5	Hardware error. Data not available.																
6	Field within request packet header contains unsupported or invalid value.																
7	Address location within specified node not accessible.																
8-Fh	Reserved																

12.5.1.2 Quadlet Transmit

Three quadlet transmit formats are shown below. In these figures: The first quadlet contains packet control information. The second and third quadlets contain 16-bit destination ID and either the 48-bit quadlet-aligned destination offset (for requests) or the response code (for responses). The fourth quadlet contains the quadlet data for read response and write quadlet request formats, or the upper 16 bits contain the data length for the block read request format.

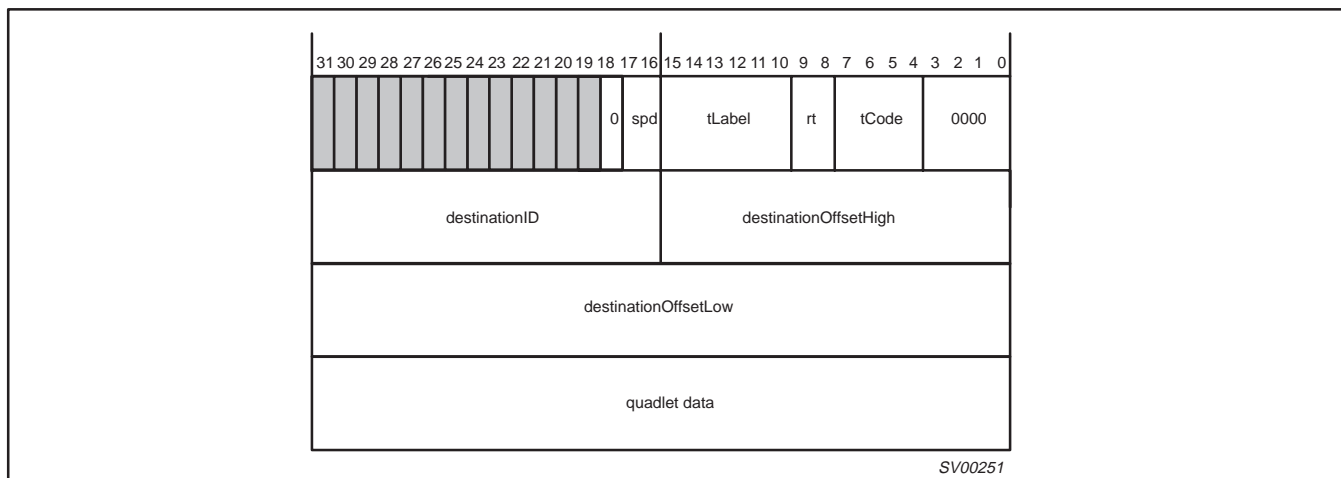

Figure 8. Quadlet Write Request Transmit Format

1394 full duplex AV link layer controller

PDI1394L21

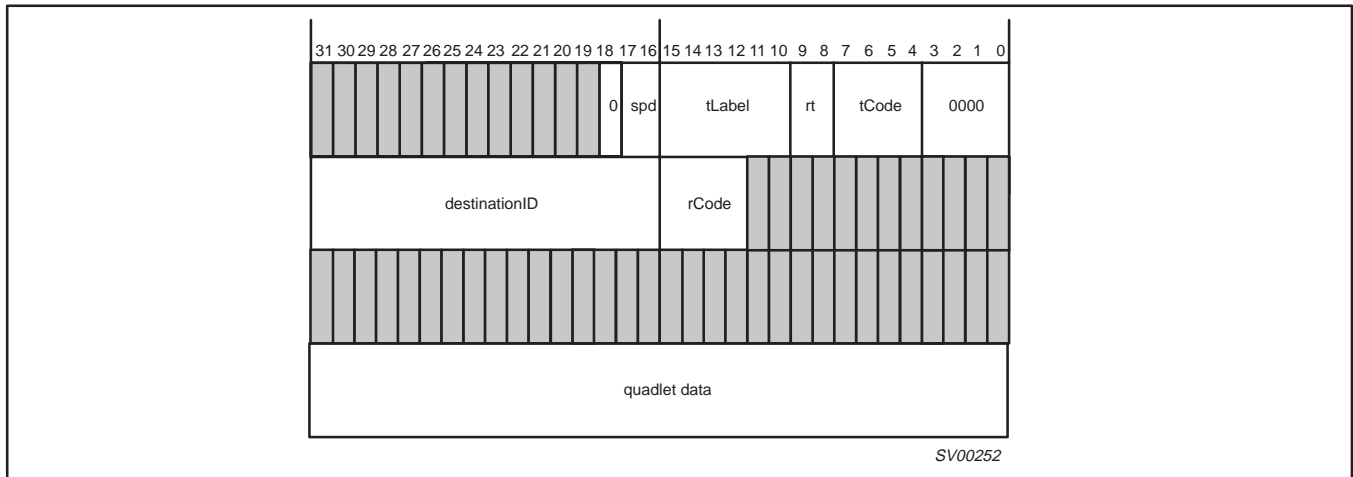

Figure 9. Quadlet Read Response Transmit Format

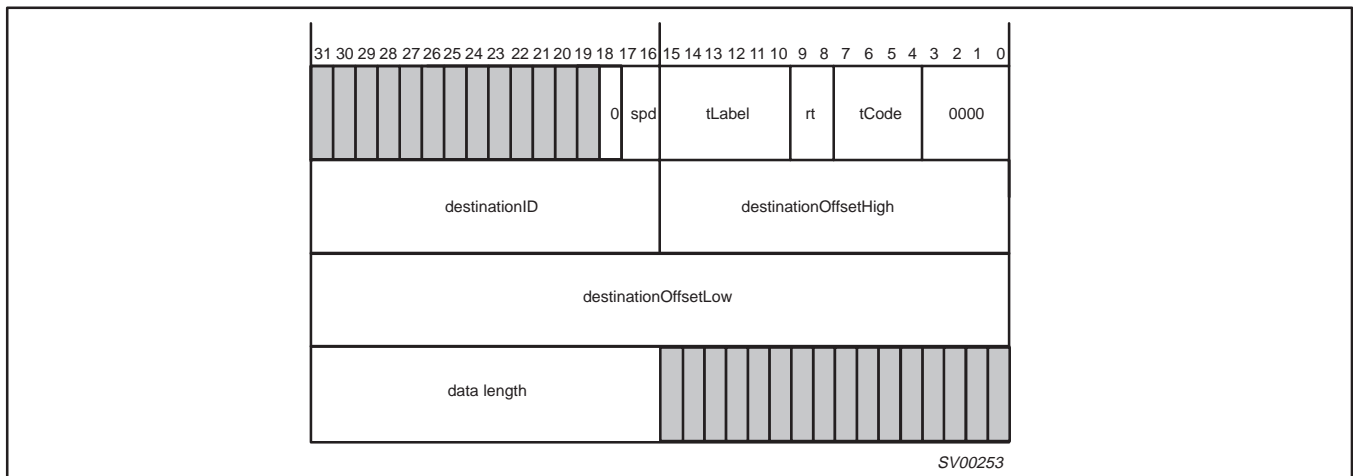

Figure 10. Block Read Request Transmit Format

Table 2. Quadlet Transmit Fields

Field Name	Description
spd, tLabel, rt, tCode, destinationID, destinationOffsetHigh, destinationOffsetLow, rCode	See Table 1.
Quadlet data	For quadlet write requests and quadlet read responses, this field holds the data to be transferred.
Data length	The number of bytes requested in a block read request.

1394 full duplex AV link layer controller

PDI1394L21

12.5.1.3 Block Transmit

The block transmit format is shown below, this is the generic format for reads and writes. The first quadlet contains packet control information. The second and third quadlets contain the 16-bit destination node ID and either the 48-bit destination offset (for requests) or the response code and reserved data (for responses). The fourth quadlet contains the length of the data field and the extended transaction code (all zeros except for lock transaction). The block data, if any, follows the extended transaction code.

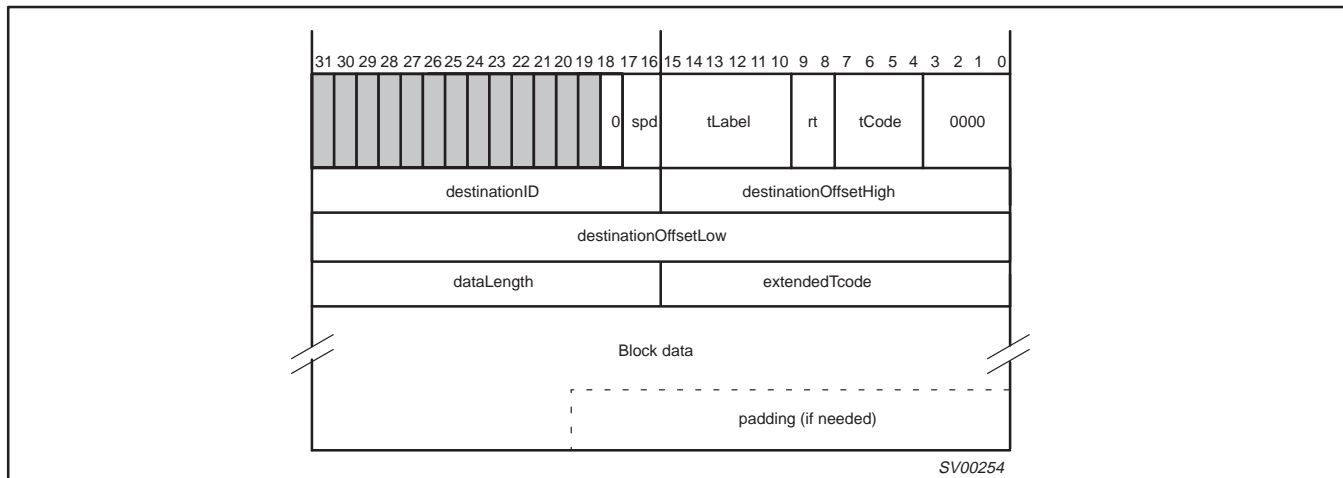

Figure 11. Block Packet Transmit Format

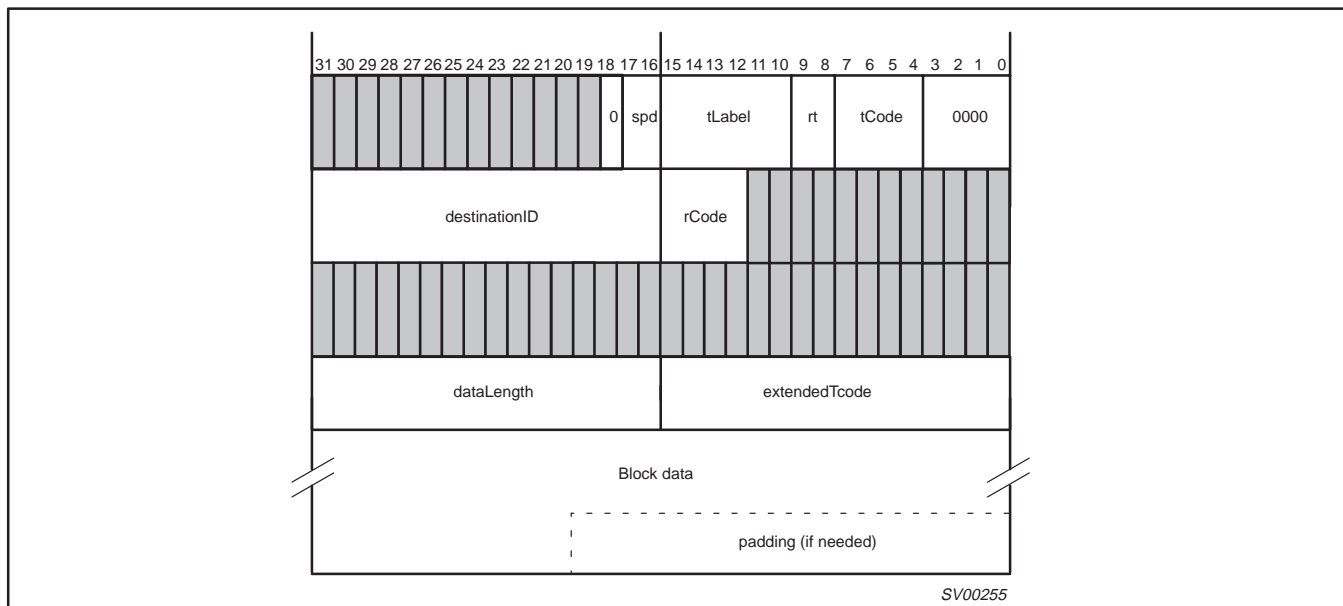

Figure 12. Block Read or Lock Response Transmit Format

1394 full duplex AV link layer controller

PDI1394L21

Table 3. Block Transmit Field

Field Name	Description
spd, tLabel, rt, tCode, destinationID, destinationOffsetHigh, destinationOffsetLow, rCode	See Table 2.
dataLength	The number of bytes of data to be transmitted in this packet
extendedTcode	The tCode indicates a lock transaction, this specifies the actual lock action to be performed with the data in this packet.
block data	The data to be sent. If dataLength=0, no data should be written into the FIFO for this field. Regardless of the destination or source alignment of the data, the first byte of the block must appear in the high order byte of the first quadlet.
padding	If the dataLength mod 4 is not zero, then zero-value bytes are added onto the end of the packet to guarantee that a whole number of quadlets is sent.

12.5.1.4 Unformatted Transmit

The unformatted transmit format is shown in Figure 13. The first quadlet contains packet control information. The remaining quadlets contain data that is transmitted without any formatting on the bus. No CRC is appended on the packet, nor is any data in the first quadlet sent. This is used to send PHY configuration and Link-on packets. Note that the bit-inverted check quadlet must be included in the FIFO since the AV Link core will not generate it.

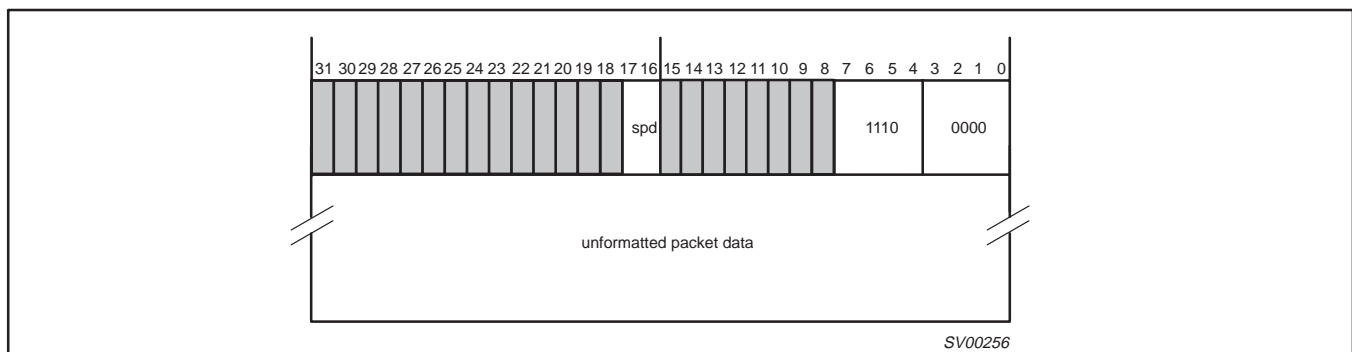

Figure 13. Unformatted Transmit Format

12.5.2 Asynchronous Receive Packet Formats

This section describes the asynchronous receive packet formats. Four basic asynchronous data packet formats and one confirmation format exist:

Table 4. Asynchronous Data Packet Formats

ITEM	FORMAT	USAGE	TRANSACTION CODE
1	No-packet data	Quadlet read requests	4
		Quadlet/block write responses	2
2	Quadlet packet	Quadlet write requests	0
		Quadlet read responses	6
3	Block Packet	Block read requests	5
		Block write requests	1
		Block read responses	7
		Lock requests	9
		Lock responses	B _{hex}
4	Self-ID / PHY packet	Concatenated self-ID / PHY packets	E _{hex}
5	Confirmation packet	Confirmation of packet transmission	8

Each packet format uses several fields. More information about most of these fields can be found in the 1394 specification.

1394 full duplex AV link layer controller

PDI1394L21

Table 5. Asynchronous Receive Fields

Field Name	Description
destinationID	This field is the concatenation of busNumbers (or all ones for "local bus") and nodeNumbers (or all ones for broadcast) for this node.
tLabel	This field is the transaction label, which is used to pair up a response packet with its corresponding request packet.
rt	The retry code for this packet. 00=retry1, 01=retryX, 10=retryA, 11=retryB.
tCode	The transaction code for this packet.
priority	The priority level for this packet (0000 for cable environment).
sourceID	This is the node ID of the sender of this packet.
destinationOffsetHigh, destinationOffsetLow	The concatenation of these two field addresses a quadlet in this node's address space.
rCode	Response code for response packets.
quadlet data	For quadlet write requests and quadlet read responses, this field holds the data received.
dataLength	The number of bytes of data to be received in a block packet.
extendedTcode	If the tCode indicates a lock transaction, this specifies the actual lock action to be performed with the data in this packet.
block data	The data received. If dataLength=0, no data will be written into the FIFO for this field. Regardless of the destination or source alignment of the data, the first byte of the block will appear in the high order byte of the first quadlet.
padding	If the dataLength mod 4 is not zero, then zero-value bytes are added onto the end of the packet to guarantee that a whole number of quadlets is sent.
u	Unsolicited response tag bit. This bit is set to one (1) if the received response was unsolicited.
ackSent	This field contains the acknowledge code that the link layer returned to the sender of the received packet. For packets that do not need to be acknowledged (such as broadcasts) the field contains the acknowledge value that would have been sent if an acknowledge had been required. The values for this field are listed in Table 6 (they also can be found in the IEEE 1394 standard).

Table 6. Acknowledge codes

Code	Name	Description
0001	ack_complete	The node has successfully accepted the packet. If the packet was a request subaction, the destination node has successfully completed the transaction and no response subaction shall follow.
0010	ack_pending	The node has successfully accepted the packet. If the packet was a request subaction, a response subaction will follow at a later time. This code shall not be returned for a response subaction.
0100	ack_busy_X	The packet could not be accepted. The destination transaction layer may accept the packet on a retry of the subaction.
0101	ack_busy_A	The packet could not be accepted. The destination transaction layer will accept the packet when the node is not busy during the next occurrence of retry phase A.
0110	ack_busy_B	The packet could not be accepted. The destination transaction layer will accept the packet when the node is not busy during the next occurrence of retry phase B.
1101	ack_data_error	The node could not accept the block packet because the data field failed the CRC check, or because the length of the data block payload did not match the length contained in the dataLength field. This code shall not be returned for any packet that does not have a data block payload.
1110	ack_type_error	A field in the request packet header was set to an unsupported or incorrect value, or an invalid transaction was attempted (e.g., a write to a read-only address).
0000, 0011, 0111 – 1100, and 1111	reserved	This revision of the AV Link will not generate other acknowledge codes, but may receive them from newer (1394 A) links. In that case, these new values will show up here.

NOTE:

- Upon receipt of a broadcast packet, if any ACK code other than ACK_DATA_ERROR is produced, assume packet receipt was OK. ACK_DATA_ERROR indicates the packet was received with an error, appropriate steps should be taken to ignore the packet and inform the sending node of the error.

1394 full duplex AV link layer controller

PDI1394L21

12.5.2.1 No-Data Receive

The no-data receive formats are shown below. The first quadlet contains the destination node ID and the rest of the packet header. The second and third quadlet contain 16-bit source ID and either the 48-bit, quadlet-aligned destination offset (for requests) or the response code (for responses). The last quadlet contains packet reception status.

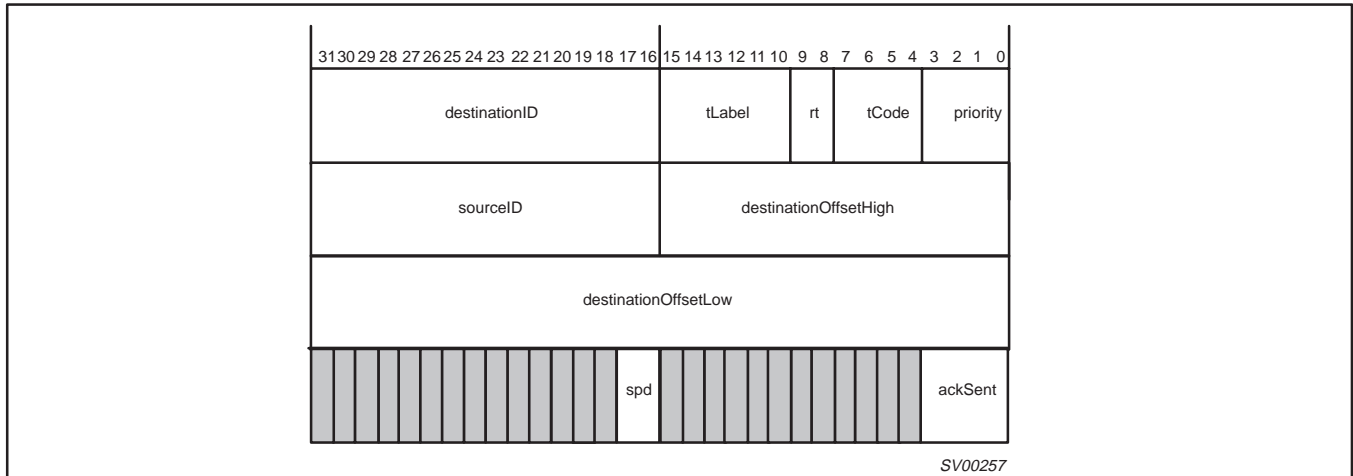

Figure 14. Quadlet Read Request Receive Format

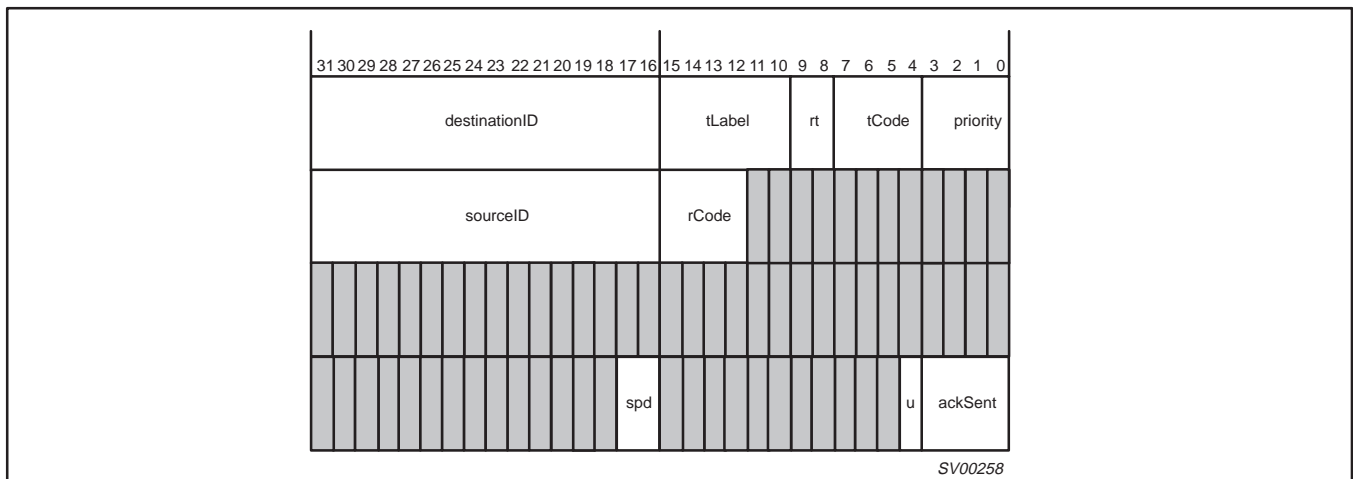

Figure 15. Write Response Receive Format

1394 full duplex AV link layer controller

PDI1394L21

12.5.2.2 Quadlet Receive

The quadlet receive formats are shown below. The first quadlet contains the destination node ID and the rest of the packet header. The second and third quadlets contain 16-bit source ID and either the 48-bit, quadlet-aligned destination offset (for requests) or the response code (for responses). The fourth quadlet is the quadlet data for read responses and write quadlet requests, and is the data length and reserved for block read requests. The last quadlet contains packet reception status.

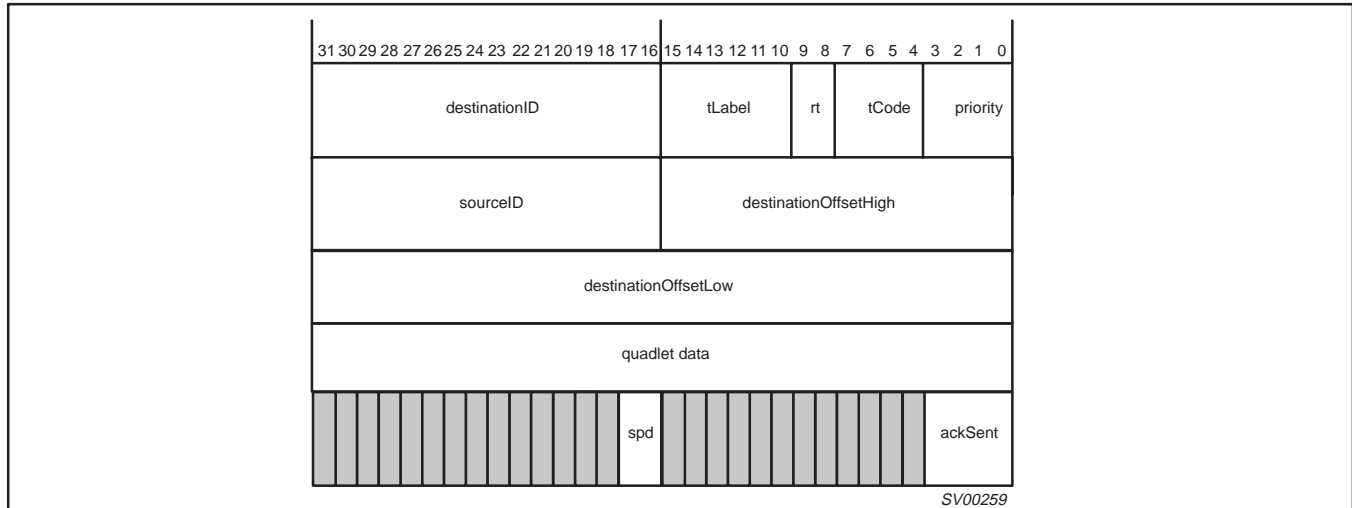

Figure 16. Quadlet Write Request Receive Format

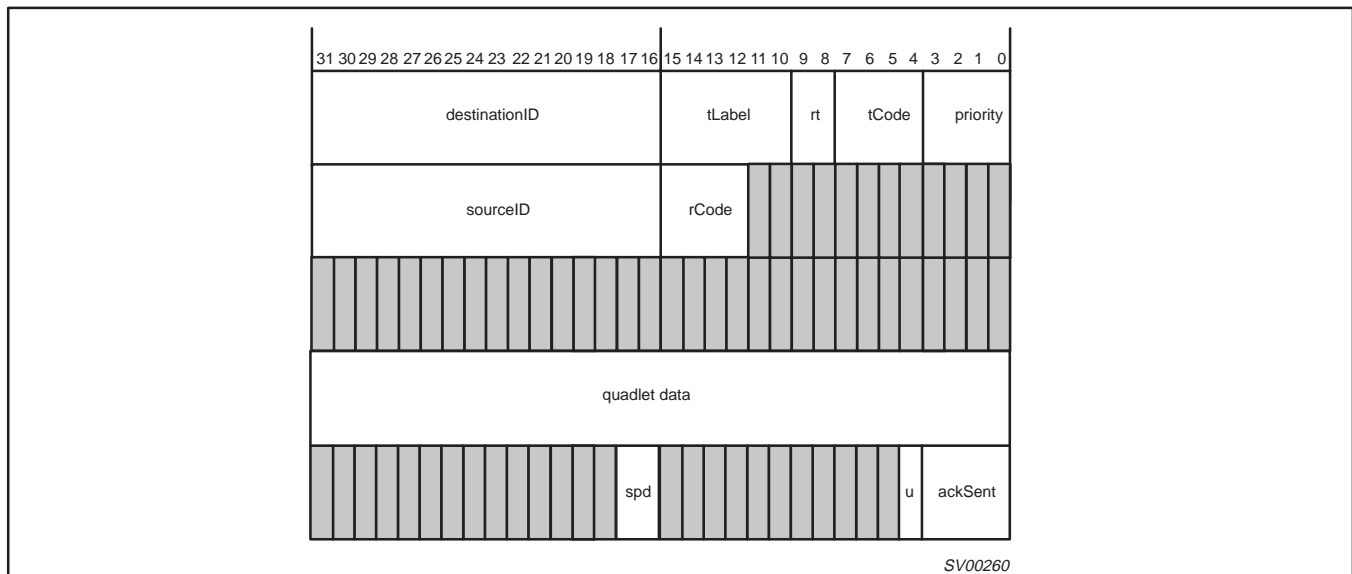

Figure 17. Quadlet Read Response Receive Format

1394 full duplex AV link layer controller

PDI1394L21

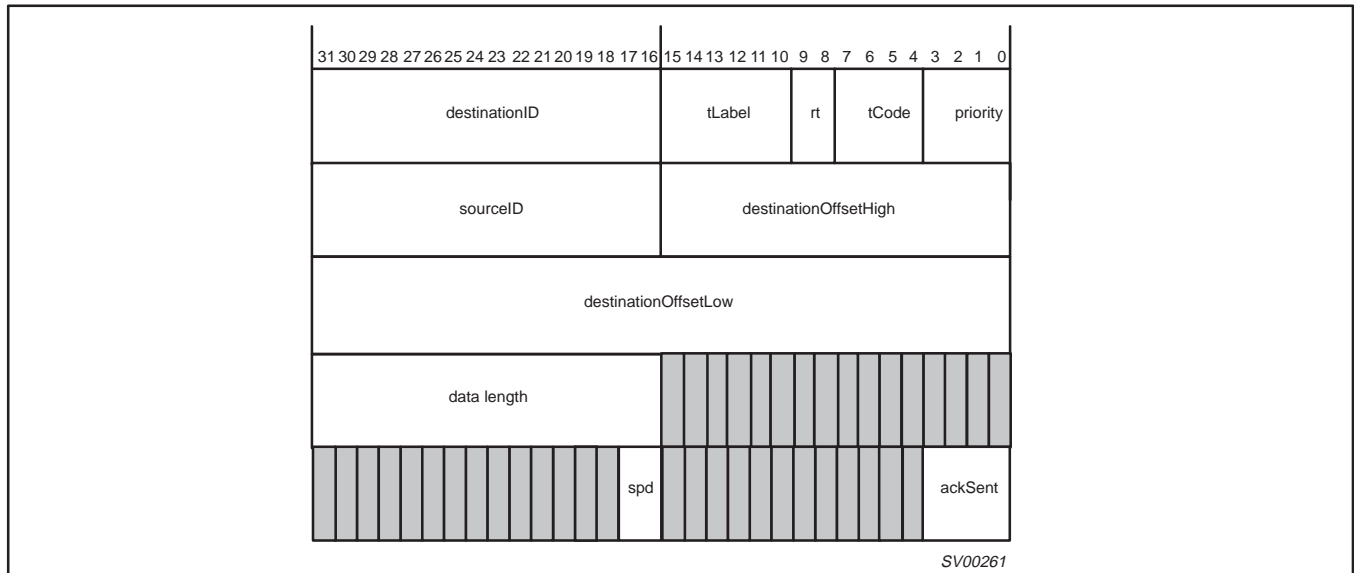

Figure 18. Block Read Request Receive Format

12.5.2.3 Block receive

The block receive format is shown below. The first quadlet contains the destination node ID and the rest of the packet header. The second and third quadlets contain 16-bit sourceID and either the 48-bit destination offset (for requests) or the response code and reserved data (for responses). The fourth quadlet contains the length of the data field and the extended transaction code (all zeros except for lock transactions). The block data, if any, follows the extended code. The last quadlet contains packet reception status.

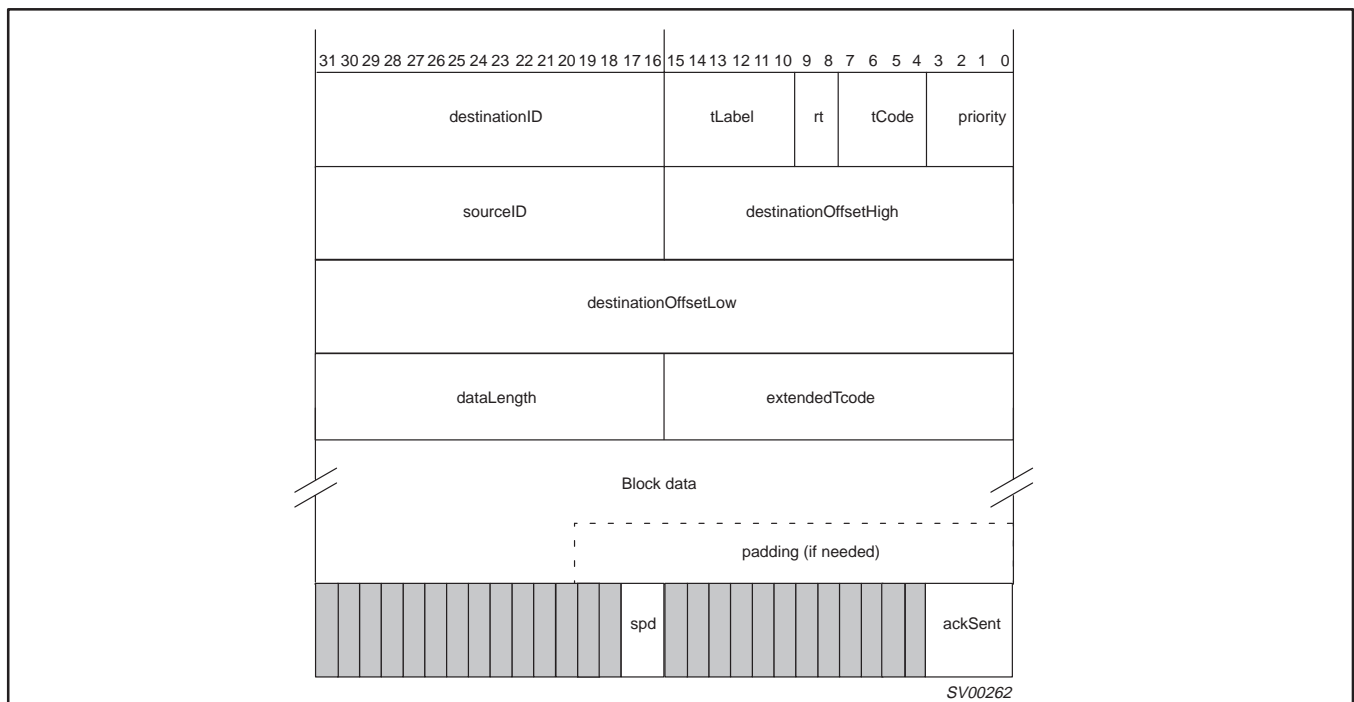

Figure 19. Block Write or Lock Request Receive Format

1394 full duplex AV link layer controller

PDI1394L21

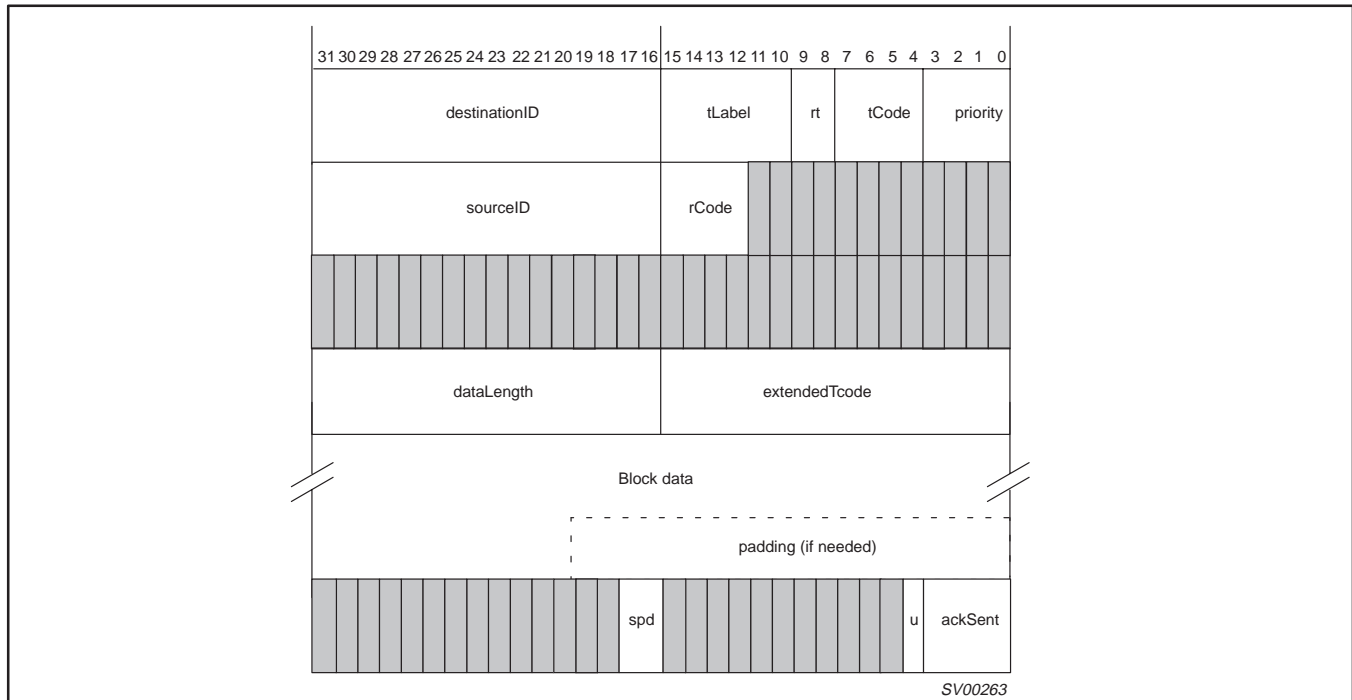

Figure 20. Block Read or Lock Response Receive Format

12.5.2.4 Self-ID and PHY packets receive

The self-ID and PHY packet receive formats are shown below. The first quadlet contains a synthesized packet header with a tCode of 0xE (hex). For self-ID information, the remaining quadlets contain data that is received from the time a bus reset ends to the first subaction gap. This is the concatenation of all the self-ID packets received. Note that the bit-inverted check quadlet is included in the Read Request FIFO and the application must check it.

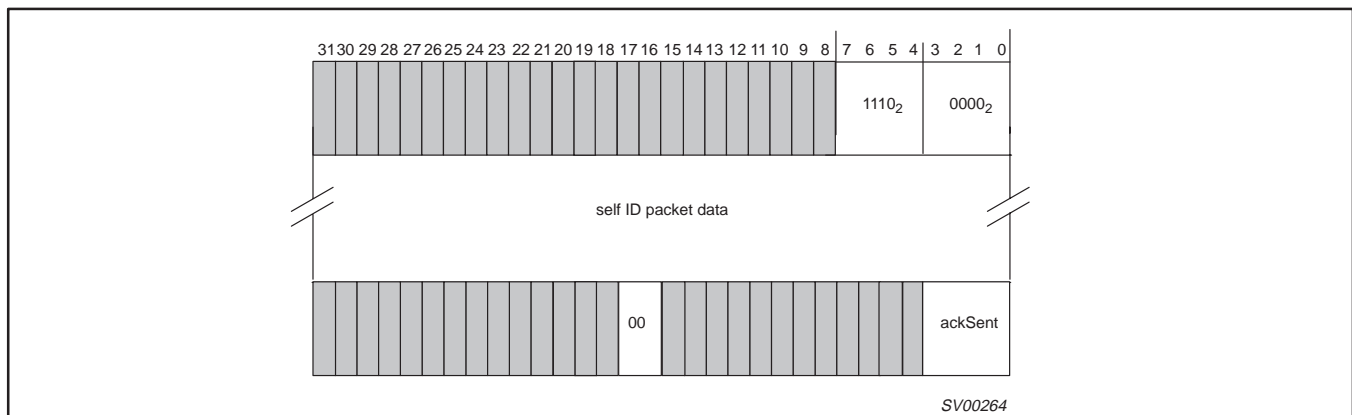

Figure 21. Self-ID Receive Format

The “ackSent” field will either be “ACK_DATA_ERROR” if a non-quadlet-aligned packet is received or there was a data overrun, or “ACK_COMPLETE” if the entire string of self-ID packets was received.

1394 full duplex AV link layer controller

PDI1394L21

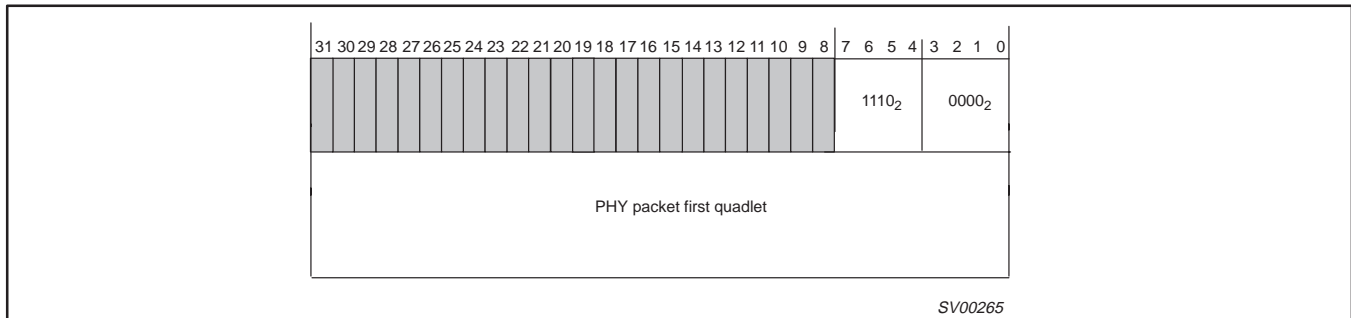

Figure 22. PHY Packet Receive Format

For PHY packets, there is a single following quadlet which is the first quadlet of the PHY packet. The check quadlet has already been verified and is not included.

12.5.2.5 Transaction data confirmation formats

After a packet from one of the queues has been transmitted, the asynchronous transmitter assembles a confirmation (see Figure 23) which is used to confirm the result of the transmission to the higher layers. Separate confirmations are assembled for request and response transmissions. Request confirmations are written into the receiver request queue and response confirmations are written into the receiver response queue.

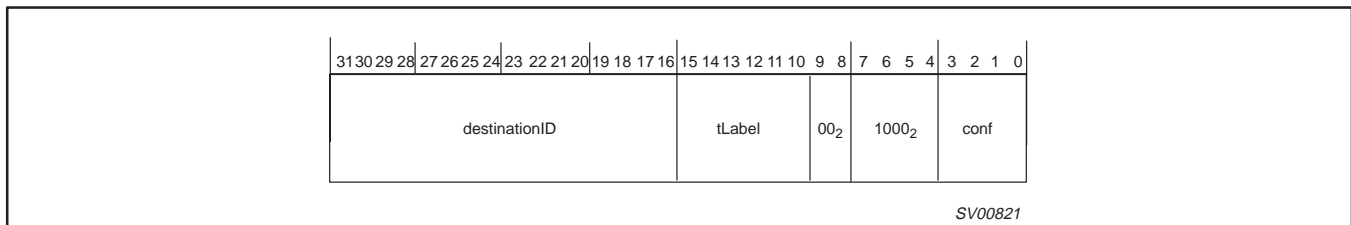

Figure 23. Request and response confirmation format

Table 7. Confirmation codes

CODE ¹	DESCRIPTION
0	Non-broadcast packet transmitted; addressed node returned no acknowledge (transaction complete).
1	Broadcast packet transmitted or non-broadcast packet transmitted; addressed node returned an acknowledge complete (transaction complete).
2	Non-broadcast packet transmitted; addressed node returned an acknowledge pending.
4	Retry limit exceeded; destination node hasn't accepted the non-broadcast packet within the maximum number of retries (transaction complete).
D ₁₆	Acknowledge data error received (transaction complete).
E ₁₆	Acknowledge type error received (transaction complete).

NOTE:

1. All other codes are reserved.

For every packet written in a transmitter queue by the CPU, there will be one confirmation written in the corresponding receiver queue by the AV layer logic.

1394 full duplex AV link layer controller

PDI1394L21

12.5.3 Interrupts

The PDI1394L21 provides a single interrupt line (HIF INT_N) for connection to a host controller. Status indications from four major areas of the device are collected and ORed together to activate HIF INT_N. Status from four major areas of the device are collected in four status registers; LNKPHYINTACK, ITXINTACK, IRXINTACK, and ASYINTACK. At this level, each individual status can be enabled to generate a chip-level interrupt by activating HIF INT_N. To aid in determining the source of a chip-level interrupt, the major area of the device generating an interrupt is indicated in the lower 4 bits of the GLOBCSR register. These bits are non-latching Read-Only status bits and do not need to be acknowledged. To acknowledge and clear a standing interrupt, the bit in LNKPHYINTACK, ITXINTACK, IRXINTACK, or ASYINTACK causing the interrupt status has to be written to a logic '1'; Note: Writing a value of '0' to the bit has no effect.

12.5.3.1 Determining and Clearing Interrupts

When responding to an interrupt event generated by the PDI1394L21, or operating in polled mode, the first register examined is the GLOBCSR register. The least significant nibble contains interrupt status bits from general sections of the device; the link layer controller, the AV transmitter, the AV receiver, and the asynchronous transceiver. The bits in GLOBCSR[3:0] are self-clearing status bits. They represent the logical OR of all the enabled interrupt status bits in their section of the AV Link Layer Controller.

Once an interrupt, or status is detected in GLOBCSR, the appropriate interrupt status register needs to be read, see the Interrupt Hierarchy diagram for more detail. After all the interrupt indications are dealt with in the appropriate interrupt status register, the interrupt status indication will automatically clear in the GLOBCSR.

All interrupt status bits in the various interrupt status registers are latching unless otherwise noted.

12.5.3.2 Interrupt Hierarchy

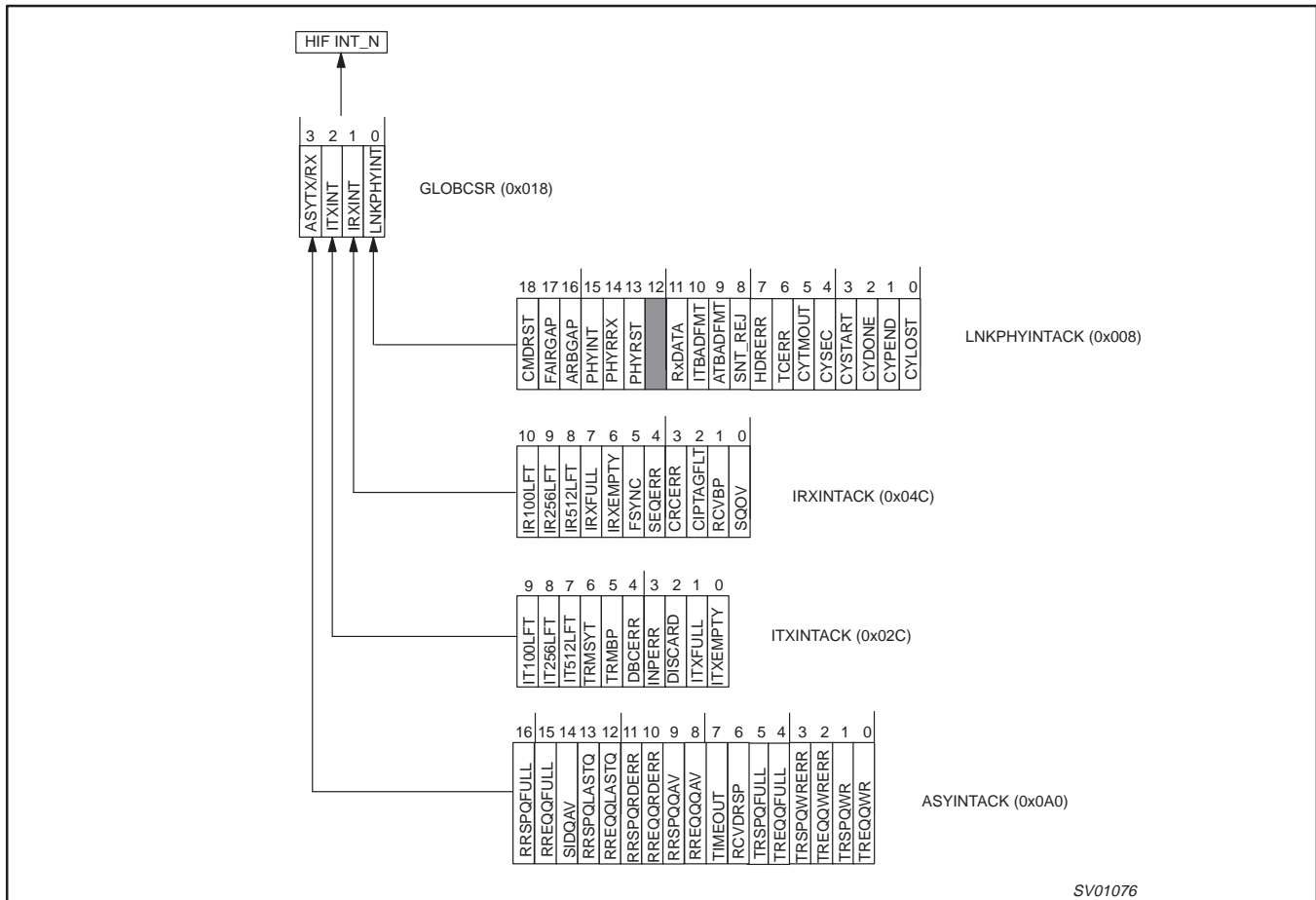

Figure 24. Interrupt Hierarchy

1394 full duplex AV link layer controller

PDI1394L21

13.0 REGISTER MAP

Registers are 32 bits (quadlet) wide and all accesses are always done on a quadlet basis. This means that it is not possible to write just the lower 8 bits, and leave the other bits unaffected (see Section 12.3.2 for more information). The values written to undefined fields/bits are ignored and thus DON'T CARE.

A full bitmap of all registers is listed in Table 8. The meaning of shading and bit cell values is as follows:

- A bit/field with no name written in it and dark shading is reserved and not used.

- A bit/field with a name in it and light shading is a READ ONLY (status) bit/field.

- A one bit value (0 or 1) written at the bottom of a writeable (control) bit is the default value after power-on-reset.

Table 8. Full Bitmap of all Registers (consists of three tables shown on the following pages)

1394 full duplex AV link layer controller

PDI1394L21

REGISTER ADDRESS	31	24	23	16	15	8	7	0														
IDREG 0x000	BUS ID				NODE ID		PART CODE		VERSION CODE													
LNKCTL 0x004	IDVALID 0	RCVSELFID 1	BSYCTRL 0 0 0 0		TXENABLE 1	RXENABLE 1	RST Tx 0	RST Rx 0	STRICTISOCH 0	CYMASTER 0	CYSOURCE 0	CYTMREN 0	TxRDY 0	ROOT 0	BUSYFLAG 0	ATAACK 0						
LNKPHYINTACK 0x008					CMRDRST 0	FAIRGAP 0	ARBGAP 0	PHYINT 0	PHYRRX 0	PHYRST 0	RxDATA 0	ITBADFMT 0	ATBADFMT 0	SNT_REJ 0	HDRERR 0	TCERR 0	CYTMOUT 0	CYSEC 0	CYSTART 0	CYDONE 0	CYPEND 0	CYLOST 0
LNKPHYINTE 0x00C					ECMRDRST 0	EFAIRGAP 0	EARBGAP 0	EPHYINT 0	EPHYRRX 0	EPHYRST 0	ERxDATA 0	EITBADFMT 0	EATBADFMT 0	ESNT_REJ 0	EHDRERR 0	ETCERR 0	ECYTMOUT 0	ECYSEC 0	ECYSTART 0	ECYDONE 0	ECYPEND 0	ECYLOST 0
CYCTM 0x010	CYCLE_SECONDS 0 0 0 0 0 0 0 0				CYCLE_NUMBER 0 0 0 0 0 0 0 0				CYCLE_OFFSET 0 0 0 0 0 0 0 0													
PHYACS 0x014	RDPHY 0	WRPHY 0	PHYRGAD 0 0 0 0		PHYRGDATA 0 0 0 0 0 0 0				PHYRXAD 0 0 0 0		PHYRXDATA 0 0 0 0 0 0 0											
GLOBCSR 0x018					ENOUTAV2 0	ENOUTAV1 0	DIRAV1 1			EASYTX/RX 0	EITXINT 0	EIRXINT 0	ELNKPHYINT 0			ASYTX/RX 0	ITXINT 0	IRXINT 0	LNKPHYINT 0			
<RESERVED> 0x01C																						
ITXPKCTL 0x020	TXAP_CLK 0 0		TRDEL 0 0 0 0 0 0				MAXBL 0 0 0 0 0 0				ENXTMSTP 0	SYT_DELAY 0	EN_ITX 0	PM 0	EN_FS 0	RST_ITX 1						
ITXHQ1 0x024					DBS 0 0 0 0 0 0				FN 0	QPC 0	SPH 0											
ITXHQ2 0x028	FMT 0 0 0 0 0 0		FDF 0 0 0 0 0 0								SYT 0 0 0 0 0 0											
ITXINTACK 0x02C											IT100LFT 0	IT256LFT 0	IT512LFT 0	TRMSYT 0	TRMBP 0	DBCERR 0	INPERR 0	DISCARD 0	ITXFULL 0	ITXEMPTY 0		
ITXINTE 0x030											EIT100LFT 0	EIT256LFT 0	EIT512LFT 0	ETRMSYT 0	ETRMBP 0	EDBCERR 0	EINPERR 0	EDISCARD 0	EITXFULL 0	EITXEMPTY 0		

SV00883

1394 full duplex AV link layer controller

PDI1394L21

REGISTER ADDRESS	31	24	23	16	15	8	7	0								
ITXCTL 0x034						TAG	CHANNEL		SPD	ODD/EVEN	0					
ITXMEM 0x038						0	0	0	0	0	0					
<RESERVED> 0x03C																
IRXPCKCTL 0x040	RXAP_CLK							SNDIMM	DIS_TSC	RMVUAP	SPAV	EN_IRX	BPAD	EN_FS	RST_IRX	
IRXHQ1 0x044	E0	F0	SID		DBS		FN	QPC	SPH							
IRXHQ2 0x048	E1	F1	FMT		FDF		SYT									
IRXINTACK 0x04C						IR100LFT	IR256LFT	IR512LFT	IRXFULL	IRXEMPTY	FSYNC	SEQERR	CRCERR	CIPTAGFLT	RCVBP	SOOV
IRXINTE 0x050						EIR100LFT	EIR256LFT	EIR512LFT	EIRXFULL	EIRXEMPTY	EF SYNC	ESEQERR	ECRCERR	ECIPTAGFLT	ERC VBP	ESOOV
IRXCTL 0x054						SPD	TAG	CHANNEL		ERR		ODD/EVEN				
IRXMEM 0x058						0	0	0	0	0	0	0	0	0	0	0
<RESERVED> 0x05C . . . <RESERVED> 0x07C																

SV00884

1394 full duplex AV link layer controller

PDI1394L21

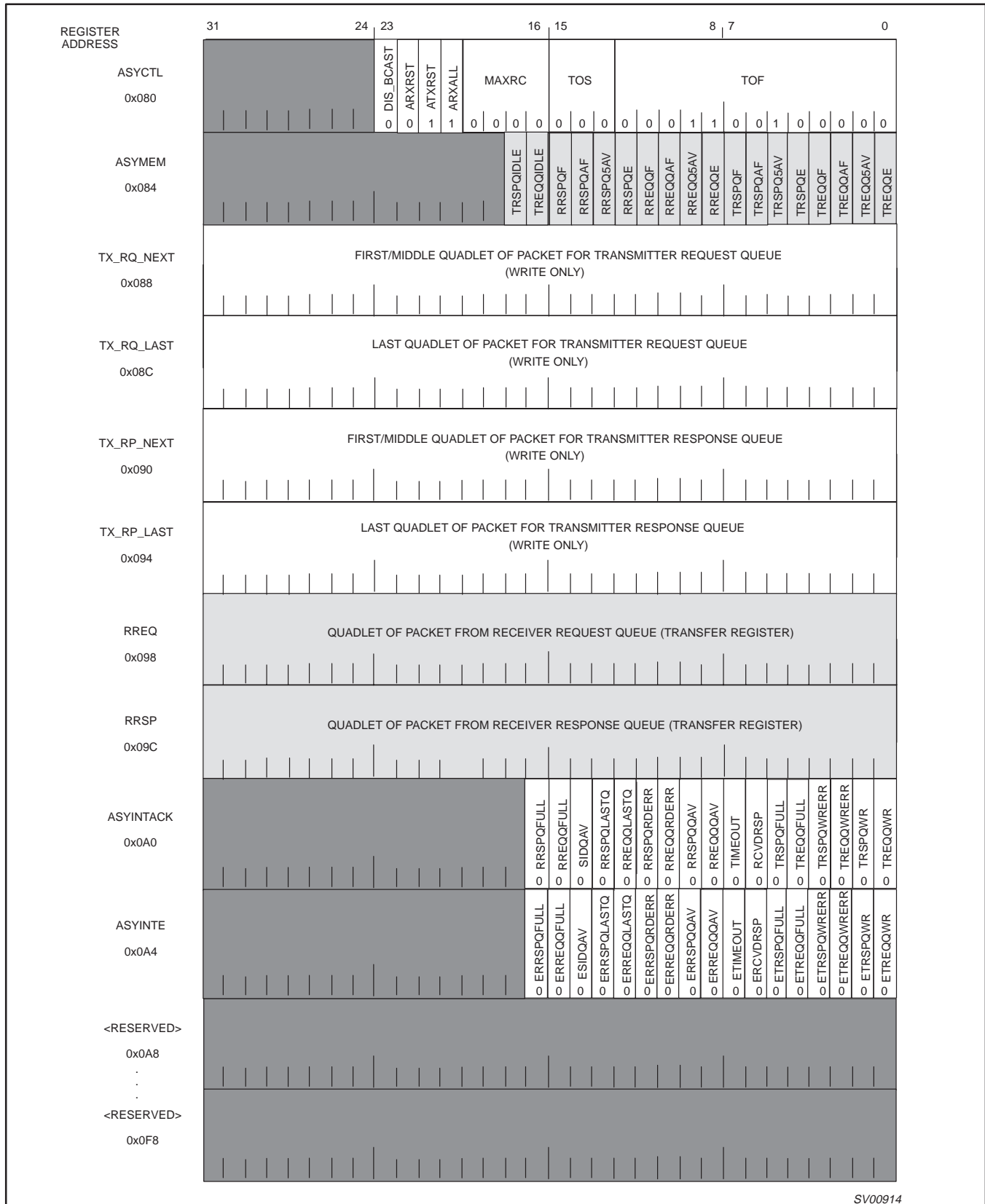

SV00914

1394 full duplex AV link layer controller

PDI1394L21

13.1 Link Control Registers

13.1.1 ID Register (IDREG) – Base Address: 0x000

The ID register is automatically updated by the attached PHY with the proper Node ID after completion of the bus reset.

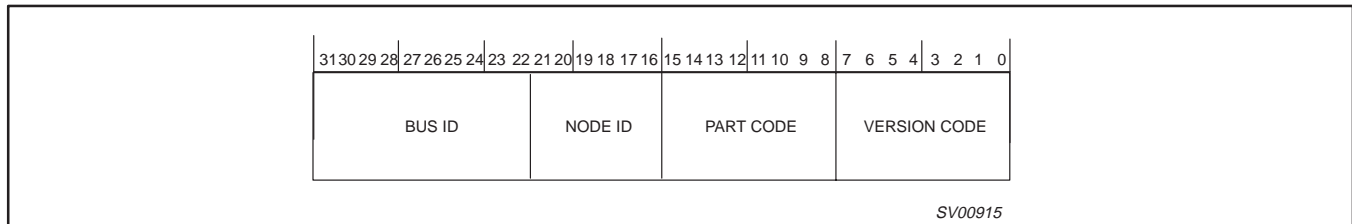

Reset Value 0xFFFF0101

- Bit 31..22: R/W BUS ID: The 10-bit bus number that is used with the Node ID in the source address for outgoing packets and used to accept or reject incoming packets. This field reverts to all '1's (0x3FF) upon bus reset.
- Bit 21..16: R/W NODE ID: Used in conjunction with Bus ID in the source address for outgoing packets and used to accept or reject incoming packets. This register auto-updates with the node ID assigned after the 1394 bus Tree-ID sequence.
- Bit 15..8: R PART CODE: "01" designates PDI1394L21.
- Bit 7..0: R VERSION CODE: "02" shows this is revision level 2 of this part.

13.1.2 General Link Control (LNKCTL) – Base Address: 0x004

The General Link control register is used to program the Link Layer isochronous transceiver, as well as the overall link transceiver. It also provides general link status.

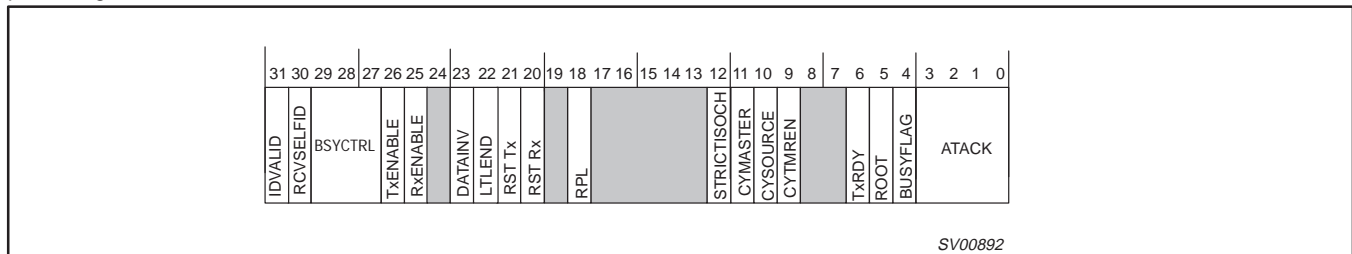

Reset Value 0x46000002

- Bit 31: R/W IDValid (IDVALID): When equal to one, the PDI1394L21 accepts the packets addressed to this node. This bit is automatically set after selfID complete and node ID is updated.
- Bit 30: R/W Receive Self ID (RCVSELFID): When asserted, the self-identification packets, generated by each PHY device on the bus, during bus initialization are received and placed into the asynchronous request queue as a single packet. Bit 30 also enables the reception of PHY configuration packets in the asynchronous request queue.
- Bit 29..27: R/W Busy Control (BSYCTRL): These bits control what busy status the chip returns to incoming packets. The field is defined below:
 - 000 = use protocol requested by received packet (either dual phase or single phase)
 - 001 = send busy A when it is necessary to send a busy acknowledge (testing/diagnostics)
 - 010 = send a busy B when it is necessary to send a busy acknowledge (testing/diagnostics)
 - 011 = use single phase retry protocol
 - 100 = use protocol requested in packet, always send a busy ack (for all packets)
 - 101 = busy A all incoming packets
 - 110 = busy B all incoming packets are '1'
 - 111 = use single phase retry protocol, always send a busy ack
- Bit 26: R/W Transmitter Enable (TxENABLE): When this bit is set, the link layer transmitter will arbitrate and send packets.
- Bit 25: R/W Receiver Enable (RxENABLE): When this bit is set, the link layer receiver will receive and respond to bus packets.
- Bit 21: R/W Reset Transmitter (RSTTx): When set to one, this synchronously resets the transmitter within the link layer.
- Bit 20: R/W Reset Receiver (RSTRx): When set to one, this synchronously resets the receiver within the link layer.
- Bit 12: R/W Strict Isochronous (STRICTISOCH): Used to accept or reject isochronous packets sent outside of specified isochronous cycles (between a Cycle Start and subaction gap). A '1' rejects packets sent outside the specified cycles, a "0" accepts isochronous packets sent outside the specified cycle.
- Bit 11: R/W Cycle Master (CYMASTER): When asserted and the PDI1394L21 is attached to the root PHY (ROOT bit = 1), and the cycle_count field of the cycle timer register increments, the transmitter sends a cycle-start packet. Cycle Master function will be disabled if a cycle timeout is detected (CYTMOUT bit 5 in LNKPHYINTACK). To restart the Cycle Master function in such a case, first reset CYMASTER, then set it again.

1394 full duplex AV link layer controller

PDI1394L21

Bit 10:	R/W	Cycle Source (CYSOURCE): When asserted, the cycle_count field increments and the cycle_offset field resets for each positive transition of CYCLEIN. When deasserted, the cycle count field increments when the cycle_offset field rolls over.
Bit 9:	R/W	Cycle Timer Enable (CYTIMREN): When asserted, the cycle offset field increments.
Bit 6:	R	Transmitter Ready (TxRDY): The transmitter is idle and ready.
Bit 5:	R	Root (ROOT): Indicates this device is the root on the bus. This automatically updates after the self_ID phase.
Bit 4:	R	Busy Flag (BUSYFLAG): The type of busy acknowledge which will be sent next time an acknowledge is required. 0 = Busy A, 1 = Busy B (only meaningful during a dual-phase busy/retry operation).
Bit 3..0:	R	AT acknowledge received (ATAACK): The last acknowledge received by the transmitter in response to a packet sent from the transmit-FIFO interface while the ATF is selected (diagnostic purposes).

13.1.3 Link /Phy Interrupt Acknowledge (LNKPHYINTACK) – Base Address: 0x008

The Link/Phy Interrupt Acknowledge register indicates various status and error conditions in the Link and Phy which can be programmed to generate an interrupt. The interrupt enable register (LNKPHYINTE) is a mirror of this register. Acknowledgment of an interrupt is accomplished by writing a '1' to a bit in this register that is set. This action reset the bit indication to a '0'. Writing a '1' to a bit that is already "0" will have no effect on the register.

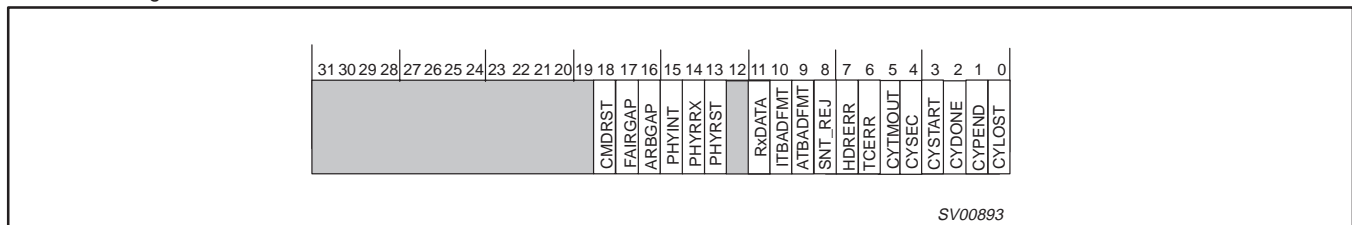

Reset Value 0x00000000

Bit 18:	R/W	Command Reset Received (CMDRST): A write request to RESET-START has been received.
Bit 17:	R/W	Fair Gap (FAIRGAP): The serial bus has been idle for a fair-gap time (called subaction gap in the IEEE 1394 specification).
Bit 16:	R/W	Arbitration Reset Gap (ARBGAP): The serial bus has been idle for an arbitration reset gap.
Bit 15:	R/W	Phy Chip Int (PHYINT): The Phy chip has signaled an interrupt through the Phy interface. This bit becomes active for any of the following reasons (1) PHY has detected a loop on the bus, (2) cable power has fallen below the minimum voltage, (3) the PHY arbitration state machine has timed-out usually indicative of a bus loop, (4) a bus cable has been disconnected. Typically, recognition and notification of any of the above events by the PHY requires between 166 and 500 microseconds; therefore, this bit is not instantaneously set.
Bit 14:	R/W	Phy Register Information Received (PHYRRX): A register has been transferred by the Physical Layer device into the Link.
Bit 13:	R/W	Phy Reset Started (PHYRST): A Phy-layer reconfiguration has started. This interrupt clears the ID valid bit. (Called Bus Reset in the IEEE 1394 specification).
Bit 11:	R/W	Receiver has data (RxDATA): The receiver has confirmed data to the receiver response/request FIFO.
Bit 10:	R/W	Isochronous Transmitter is Stuck (ITBADFMT): The transmitter has detected invalid data at the transmit-FIFO interface when the ITF is selected.
Bit 9:	R/W	Asynchronous Transmitter is Stuck (ATBADFMT): The transmitter expected start of new async packet in queue, but found other data (out of sync with user). Reset to clear.
Bit 8:	R/W	Busy Acknowledge Sent by Receiver (SNT_REJ): The receiver was forced to send a busy acknowledge to a packet addressed to this node because the receiver response/request FIFO overflowed.
Bit 7:	R/W	Header Error (HDRERR): The receiver detected a header CRC error on an incoming packet that may have been addressed to this node.
Bit 6:	R/W	Transaction Code Error (TCERR): The transmitter detected an invalid transaction code in the data at the transmit FIFO interface.
Bit 5:	R/W	Cycle Timed Out (CYTMOUIT): ISOCH cycle lasted more than 125µs from Cycle-Start to Fair Gap: Disables cycle master function
Bit 4:	R/W	Cycle Second incremented (CYSEC): The cycle second field in the cycle-timer register incremented. This occurs approximately every second when the cycle timer is enabled.
Bit 3:	R/W	Cycle Started (CYSTART): The transmitter has sent or the receiver has received a cycle start packet.
Bit 2:	R/W	Cycle Done (CYDONE): A fair gap has been detected on the bus after the transmission or reception of a cycle start packet. This indicates that the isochronous cycle is over; Note: Writing a value of '0' to the bit has no effect.
Bit 1:	R/W	Cycle Pending (CYPEND): Cycle pending is asserted when cycle timer offset is set to zero (rolled over or reset) and stays asserted until the isochronous cycle has ended.
Bit 0:	R/W	Cycle Lost (CYLOST): The cycle timer has rolled over twice without the reception of a cycle start packet. This only occurs when cycle master is not asserted.

1394 full duplex AV link layer controller

PDI1394L21

13.1.4 Link / Phy Interrupt Enable (LNKPHYINTE) – Base Address: 0x00C

This register is a mirror of the Link/Phy Interrupt Acknowledge (LNKPHYINTACK) register. Enabling an interrupt is accomplished by writing a '1' to the bit corresponding to the interrupt desired.

This register enables the interrupts described in the Link /Phy Interrupt Acknowledge register (LNKPHYINTACK) description. A one in any of the bits enables that function to create an interrupt. A zero disables the interrupt, however the status is readable in the Link /Phy Interrupt Acknowledge register.

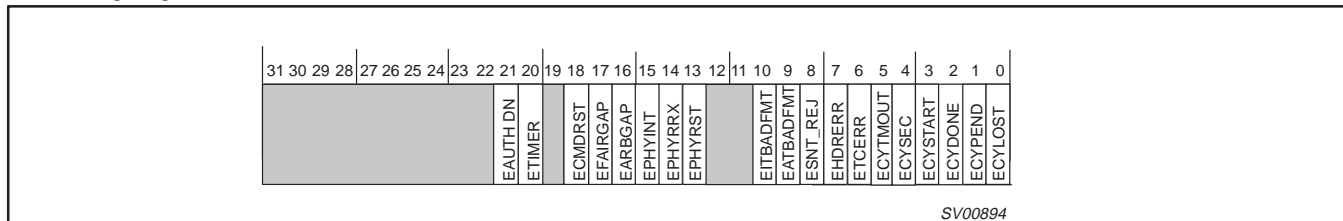

Reset Value 0x00000000

Bits 18..0 are interrupt enable bits for the Link/Phy Interrupt Acknowledge (LNKPHYINTACK).

13.1.5 Cycle Timer Register (CYCTM) – Base Address: 0x010

Cycle Timer Register operation is controlled by the Cycle Timer Enable (CYTMREN) bit in the Link Control Register (LNKCTL, 0x004).

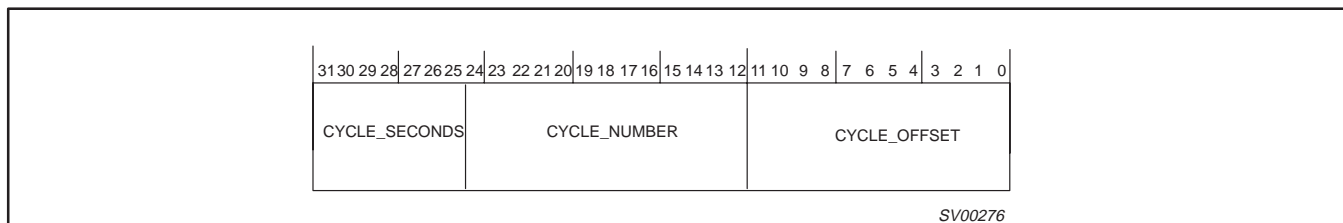

Reset Value 0x00000000

- Bit 31..25: R/W Seconds count: 1-Hz cycle timer counter.
- Bit 24..12: R/W Cycle Number: 8kHz cycle timer counter.
- Bit 11..0: R/W Cycle Offset: 24.576MHz cycle timer counter.

13.1.6 Phy Register Access (PHYACS) – Base Address: 0x014

This register provides access to the internal registers on the Phy. There are special considerations when reading or writing to this register. When reading a PHY register, the address of the register is written to the PHYRGAD field with the RDPHY bit set. The PHY data will be valid when the PHYRRX bit (LNKPHYINTACK register bit 14) is set. Once this happens the register data is available in the PHYRXDATA, the address of the register just read is also available in the PHYRXAD fields. When writing a Phy register, the address of the register to be written is set in the PHYRGAD field and the data to be written to the register is set in PHYRGDATA, along with the WRPHY bit being set. Once the write is complete, the WRPHY bit will be cleared. Do not write a new Read/Write command until the previous one has been completed. After the Self-ID phase, PHY register 0 will be read automatically.

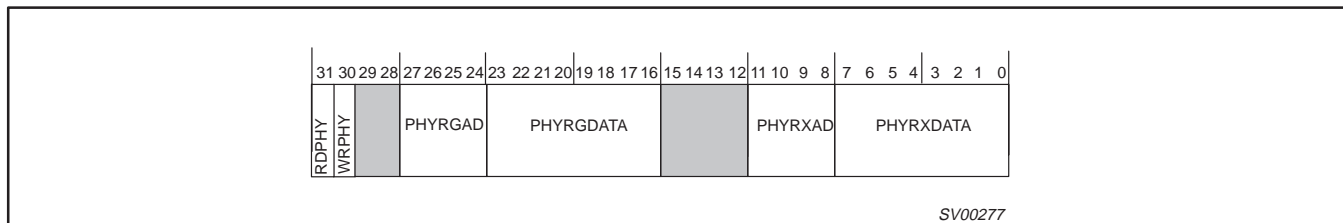

Reset Value 0x00000000

- Bit 31: R/W Read Phy Chip Register (RDPHY): When asserted, the PDI1394L21 sends a read register request with address equal to Phy Rg Ad to the Phy interface. This bit is cleared when the request is sent.
- Bit 30: R/W Write Phy Chip Register (WRPHY): When asserted, the PDI1394L21 sends a write register request with address equal to Phy Rg Ad to the Phy interface. This bit is cleared when the request is sent.
- Bit 27..24: R/W Phy Chip Register Address (PHYRGAD): This is the address of the Phy-chip register that is to be accessed.
- Bit 23..16: R/W Phy Chip Register Data (PHYRGDATA): This is the data to be written to the Phy-chip register indicated in Phy Rg Ad.
- Bit 11..8: R Phy Chip Register Received Address (PHYRXAD): Address of register from which Phy Rx Data came.
- Bit 7..0: R Phy Chip Register Received Data (PHYRXDATA): Data from register addressed by Phy Rx Ad.

1394 full duplex AV link layer controller

PDI1394L21

13.1.7 Global Interrupt Status and TX Control (GLOBCSR) – Base Address: 0x018

This register is the top level interrupt status register. If the external interrupt line is set, this register will indicate which major portion of the AV Link generated the interrupt. There is no interrupt acknowledge required at this level. These bits auto clear when the interrupts in the appropriate section of the device are cleared or disabled. Control of the AV transceiver is also provided by this register.

Bits 0 to 3 are used to identify which internal modules are currently generating an interrupt. After identifying the module, the appropriate register in that module must be read to determine the exact cause of the interrupt.

NOTES

1. There can be more than one interrupt source active at the same time.
2. The HIF INT_N signal (pin 28) remains active as long as there is at least one more enabled active interrupt status bit.

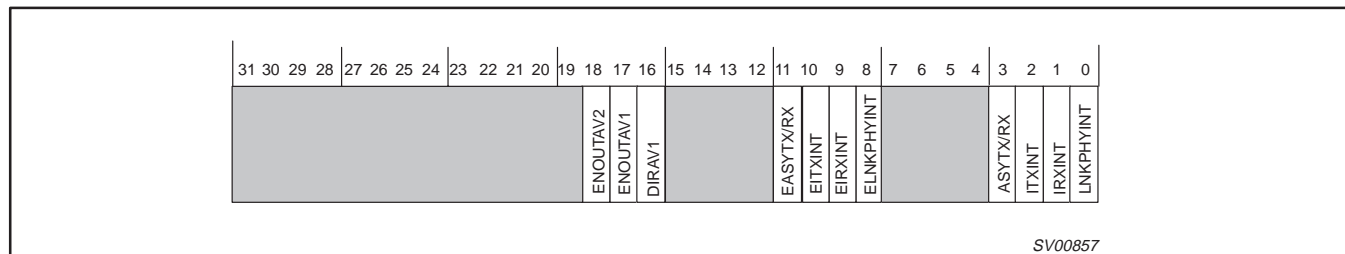

Reset Value 0x00010000

- Bit 18: R/W Enable output AVPORT2: A '1' enables AVPORT2 as an output. A '0' sets the 3-State condition on the port. In 3-State condition the port may be used as an input or unused output according to the state of DIRAV1 (bit 16).
- Bit 17: R/W Enable output AVPORT1: A '1' enables AVPORT1 as an output. A '0' sets the 3-State condition on the port. In 3-State condition the port may be used as an input or unused output according to the state of DIRAV1 (bit 16).
- Bit 16: R/W Direction of AVPORT1 (DIRAV1): A '1' enables AVPORT1 as a transmitter, thus AVPORT1 pins are inputs. A '0' configures AVPORT1 as a receiver, AVPORT1 pins are outputs in this configuration. The configuration of AVPORT2 pins is opposite of AVPORT1 pins. When AVPORT1 is set to transmit, AVPORT2 receives and vice versa.
- Bit 11: R/W Enables generation of external interrupt by asynchronous transmitter and receiver module (ASYTX/RX, bit 3) when set (1). Disables such interrupts when clear (0) (regardless of ASYINTE contents).
- Bit 10: R/W Enables generation of external interrupt by the isochronous transmitter module (ITXINT, bit 2) when set (1). Disables such interrupts when clear (0) (regardless of ITXINTE contents).
- Bit 9: R/W Enables generation of external interrupt by the isochronous receiver module (IRXINT, bit 1) when set (1). Disables such interrupts when clear (0) (regardless of IRXINTE contents).
- Bit 8: R/W Enables generation of external interrupt by general link/phy module (LNKPHYINT, bit 0) when set (1). Disables such interrupts when clear (0) (regardless of LNKPHYINTE contents).
- Bit 3: R Asynchronous Transmitter/Receiver Interrupt (ASYTX/RX): Interrupt source is in the Asynchronous Transmitter/Receiver Interrupt Acknowledge/Source register.
- Bit 2: R AV Transmitter Interrupt (ITXINT): Interrupt source is in the AV Transmitter Interrupt Acknowledge/Source register.
- Bit 1: R AV Receiver Interrupt (IRXINT): Interrupt source is in the AV Receiver Interrupt Acknowledge/Source register.
- Bit 0: R Link-Phy Interrupt (LNKPHYINT): Interrupt source is in the Link Phy Interrupt Acknowledge register.

1394 full duplex AV link layer controller

PDI1394L21

13.2 AV (Isochronous) Transmitter and Receiver Registers

13.2.1 Isochronous Transmit Packing Control and Status (ITXPCKTL) – Base Address: 0x020

This register allows the user to set up the appropriate AV packets from data entered into the AV interface. The packing and control parameters (TRDEL, MAXBL, DBS, FN, QPC, and SPH) should never be changed while the transmitter is operating. The only exception to this is the MAXBL parameter when in MPEG-2 packing mode.

NOTE: When reset of isochronous transmitter is necessary, first disable the transmitter (place bit 4, EN_ITX, LOW), wait for FIFO to empty, then reset the transmitter (place RST_ITX, bit 0, HIGH). This procedure will ensure that data in the FIFO is transmitted before reset.

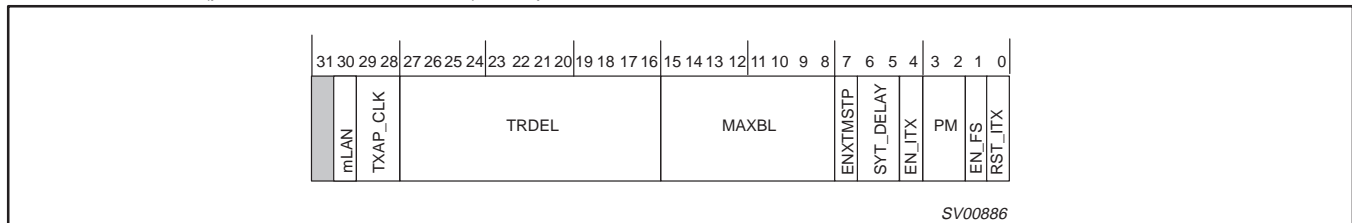

Reset Value 0x00000001

- Bit 29..28: R/W TXAP_CLK: Application Clock, default mode, '00' the AVxCLK pin is an input. This pin can become an application clock for the isochronous Transmitter (and output) by programming it to '01', '10', or '11'.
The programming values are:
00 Input
01 24.576MHz
10 12.288MHz
11 6.144MHz

Note that when enabled as '01', '10', or '11', the AV port that is configured as transmitter and enabled will output this clock signal on its AVxCLK pin.
- Bit 27..16: R/W TRDEL: Transport delay. Value added to cycle timer to produce time stamps. Lower 4 bits add to upper 4 bits of cycle_offset, (Cycle Timer Register, CYCTM). Remainder adds to cycle_count field.
- Bit 15..8: R/W MAXBL: The (maximum) number of data blocks to be put in a payload.
- Bit 7: R/W ENXTMSTP: Enable External time stamp control. Allows an external time stamp (generated by the application) to be inserted in place of the link-generated time stamp. Defaults to link generated time stamp. The application must present the first byte of a quadlet-wide time stamp accompanied by the AVSYNC pulse (and AVVALID) to the AVPORT. The external time stamp quadlet is inputted first, followed by the application data packet. The transmitted packet size is now one quadlet larger than the original isochronous data packet—Set up the isochronous transmitter accordingly with SPH = 1. **CAUTION:** Unless valid IEC 61883 time stamp format (based on the link cycle timer) is used, the receiving node link chip must be equipped with a time stamp check disabling function similar to the DIS_TSC bit (register 0X040, Bit 7). Please see section 13.2.8 for details.
- Bit 6..5: R/W SYT_DELAY: Programmable delay of AV1FSYNC and AV2FSYNC. Each cycle is 1 bus cycle, 125 μs.
Reset value is "00", a 3 cycle delay.
01 = 2 cycles
00 = 3 cycles
10 = 4 cycles
11 = Reserved
- Bit 4: R/W EN_ITX: Enable receipt of new application packets and generation of isochronous bus packets in every cycle. This bit also enables the Link Layer to arbitrate for the transmitter in each subsequent bus cycle. When this bit is disabled (0), the current packet will be transmitted and then the transmitter will shut down.
- Bit 3..2: R/W PM: packing mode:
00 = variable sized bus packets, most generic mode.
01 = fixed size bus packets.
10 = MPEG-2 packing mode.
11 = No data, just CIP headers are transmitted.
- Bit 1: R/W EN_FS:enable generation/insertion of SYT stamps (Time Stamps) in CIP header.
- Bit 0: R/W Reset Isochronous Transmitter (RST_ITX): causes transmitter to be reset when '1'. In order for synchronous reset of ITX to work properly, an AVxCLK (from either the internal or external source) must be present and ensure that the reset bit is kept (programmed) HIGH for at least the duration of one AVxCLK period. Failure to do so may cause the application interface of this module to be improperly reset (or not reset at all). When reset is enabled, all bytes will be flushed from the FIFO and transmission will cease immediately.

1394 full duplex AV link layer controller

PDI1394L21

13.2.2 Common Isochronous Transmit Packet Header Quadlet 1 (ITXHQ1) – Base Address: 0x024

The AV Transmit Packing Control register holds the specification for the packing scheme used on the AV data stream. This information is included in Common Isochronous Packet (CIP) header quadlet 1.

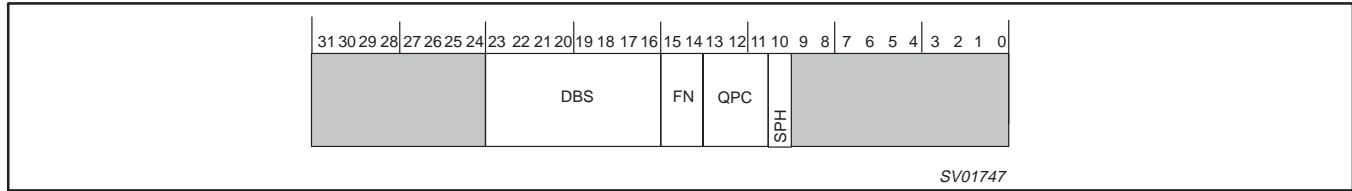

Reset Value 0x00000000

- Bit 16..23: R/W DBS: Size of the data blocks from which AV payload is constructed. The value 0 represents a length of 256 quadlets.
- Bit 14..15: R/W FN: (Fraction Number) The encoding for the number of data blocks into which each source packet shall be divided (00 = 1, 01 = 2, 10 = 4, 11 = 8).
- Bit 11..13: R/W QPC: Number of dummy quadlets to append to each source packet before it is divided into data blocks of the specified size. The value QPC must be less than DBS and less than 2^{FN} .
- Bit 10: R/W SPH: Indicates that a 25-bit CYCTM based time stamp has to be inserted before each application packet.

13.2.3 Common Isochronous Transmit Packet Header Quadlet 2 (ITXHQ2) – Base Address: 0x028

The contents of this register are copied to the second quadlet of the CIP header and transmitted with each isochronous packet.

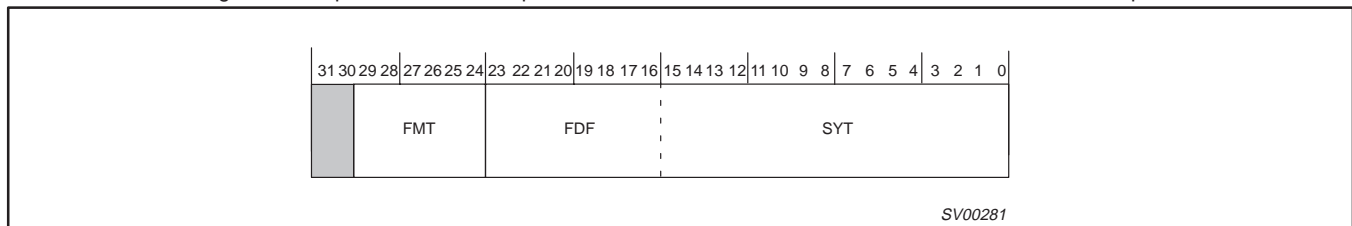

Reset Value 0x00000000

- Bit 29..24: R/W FMT: Value to be inserted in the FMT field in the AV header.
- Bit 23..0: R/W FDF/SYT: Value to be inserted in the FDF field. When the EN_FS bit in the Transmit Control and Status Register (ITXPKCTL) is set (=1), the lower 16 bits of this register are replaced by an SYT stamp if a rising edge on AVFSYNCIN has been detected or all '1's if no such edge was detected since the previous packet. The upper 8 bits of the register are sent as they appear in the FDF register. When the EN_FS bit in the Transmit Control and Status Register is unset (=0), the full 24 bits can be set to any application specified value.

1394 full duplex AV link layer controller

PDI1394L21

13.2.4 Isochronous Transmitter Interrupt Acknowledge (ITXINTACK) – Base Address: 0x02C

The AV Transmitter Interrupt Control and Status register is the interrupt register for the AV transmitter.

Bits 2, 3, and 4 "auto repair" themselves, i.e. AVLINK will detect the situation and attempt to recover on its own. The host controller still needs to clear these interrupts to be alerted the next time.

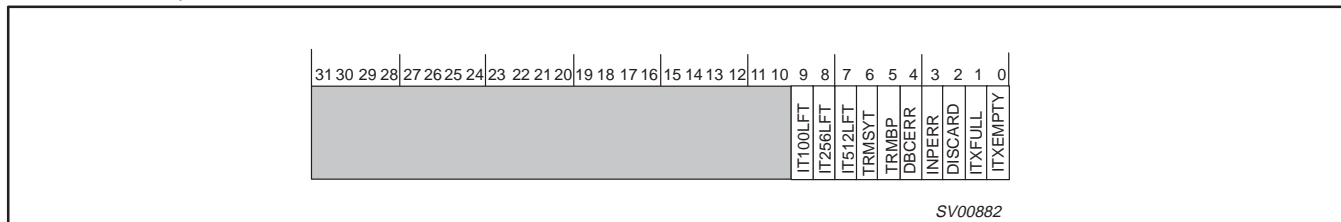

Reset Value 0x00000000

Bits 9 .. 0 are interrupt acknowledge bits; and are defined as:

- Bit 9: R/W IT100LFT: Interrupt when transmitter queue reaches 100 quadlets from full. (924 of 1024 quadlets in queue)
 - Bit 8: R/W IT256LFT: Interrupt when transmitter queue reaches 256 quadlets from full. (768 of 1024 quadlets in queue)
 - Bit 7: R/W IT512LFT: Interrupt when transmitter queue reaches 50% of full. (512 of 1024 quadlets in queue)
 - Bit 6: R/W TRMSYT: Interrupt on transmission of a SYT in CIP header quadlet 2
 - Bit 5: R/W TRMBP: Interrupt on payload transmission/discard complete.
 - Bit 4: R/W DBCERR: Acknowledge interrupt on Data Block Count (DBC) synchronization loss.
 - Bit 3: R/W INPERR: Acknowledge interrupt on input error (input data discarded).
 - Bit 2: R/W DISCARD: Interrupt on lost cycle (payload discarded).
 - Bit 1: R/W ITXFULL: Interrupt on isochronous memory bank full. This is a fatal error, the recommended action is to reset and re-initialize the transmitter.
 - Bit 0: R/W ITXEMPTY: Interrupt on isochronous memory bank empty.
- Other bits will always read '0'.

13.2.5 Isochronous Transmitter Interrupt Enable (ITXINTE) – Base Address: 0x030

These are the enabled bits for the AV Transmitter Control.

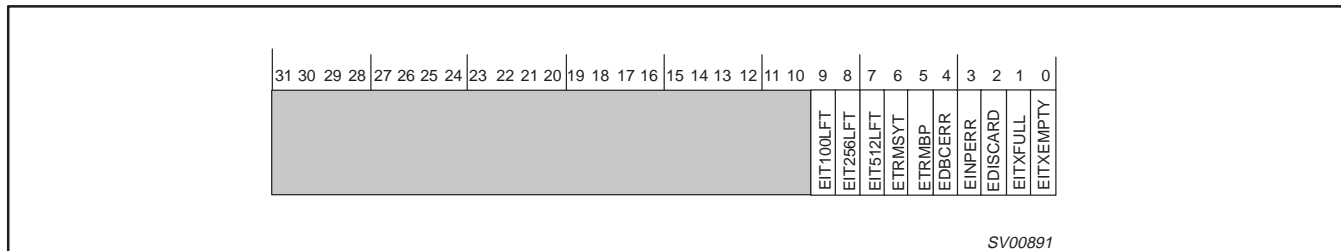

Reset Value 0x00000000

Bits 9..0 are interrupt enable bits for the Isochronous Transmitter Interrupt Acknowledge register (ITXINTACK).

1394 full duplex AV link layer controller

PDI1394L21

13.2.6 Isochronous Transmitter Control Register (ITXCTL) – Base Address: 0x34

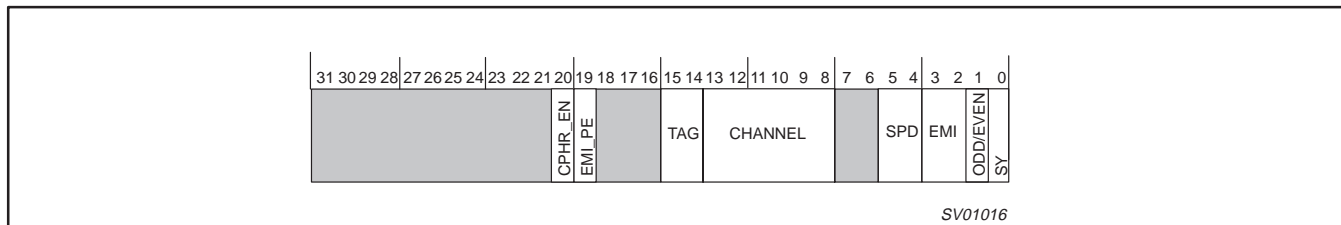

Reset Value 0x00000000

- Bit 15..14: R/W Tag: Tag code to insert in isochronous bus packet header. Should be '01' for IEC 61883 International Standard data.
- Bit 13..8: R/W Channel: Isochronous channel number.
- Bit 5..4: R/W Speed: Cable transmission speed (S100, S200, S400).
 - 00 = 100Mbps
 - 01 = 200Mbps
 - 10 = 400Mbps
 - 11 = reserved
- Bit 3..0 R Sync: Code to insert in SY field of isochronous bus packet header. Bit 1 is odd/even bit used for encryption key (0 = even, 1 = odd). Bit value determined by state of transmit port AVxENKEY pin. Some data encryption schemes require that an ODD/EVEN bit accompany each application packet sent for the purpose of changing "keys" after short intervals of time (makes breaking an encryption code more difficult). The PDI1394L21 uses the sync field ODD/EVEN bit for this purpose. Data is inputted to the transmitting AV port accompanied by the state of the ODD/EVEN bit presented to the AVx ENKEY pin. The pin state at the rising edge of the AVCLK as the first byte of the packet determines the ODD/EVEN "key" state for that packet. The ODD/EVEN key state may change as often as required, provided that 2 key changes do not appear in the transmit FIFO simultaneously. If this rule is observed, the proper "key" state will accompany the packet on to the 1394 bus and through the receiving node's receive FIFO. As the packet is being outputted at the receive node's PDI1394L21, the accompanying ODD/EVEN key state will be output. The key state remains for all bytes of the packet. Typical change rates for the ODD/EVEN key are between 1 change per second and a change every 30 seconds.

13.2.7 Isochronous Transmitter Memory Status (ITXMEM) – Base Address: 0x038

The AV Transmitter Memory Status register reports on the condition of the internal memory buffer used to store incoming AV data streams before transmission over the 1394 bus.

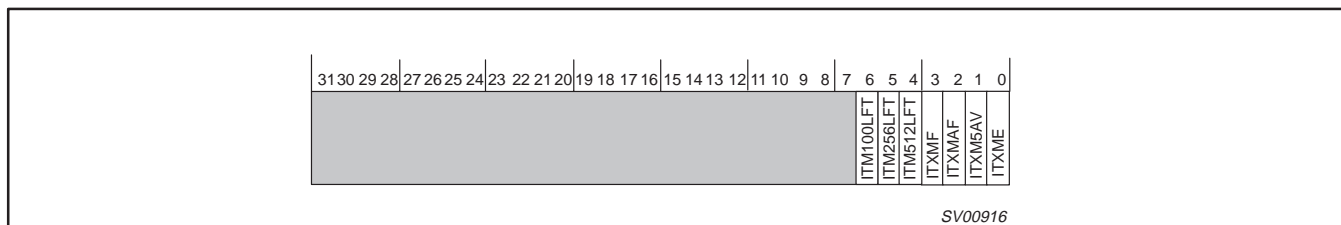

Reset Value 0x00000003

- Bit 6: R ITM100LFT: Memory has 100 quadlets of space remaining before becoming full.
- Bit 5: R ITM256LFT: Memory has 256 quadlets of space remaining before becoming full.
- Bit 4: R IITM512LFT: Memory is 1/2 full.
- Bit 3: R ITXMF: memory is completely full, no storage available.
- Bit 2: R ITXMAF: almost full, exactly one quadlet of storage available.
- Bit 1: R ITXM5AV: at least 5 more quadlets of storage available.
- Bit 0: R ITXME: memory bank is empty (zero quadlets stored).

1394 full duplex AV link layer controller

PDI1394L21

13.2.8 Isochronous Receiver Unpacking Control (IRXPKCTL) – Base Address: 0x040

NOTE: When receiver reset is required, first disable receiver (EN_IRX = 0), then wait until Rx FIFO is emptied, then perform the reset. This will allow previously received packets to go to the application instead of being lost.

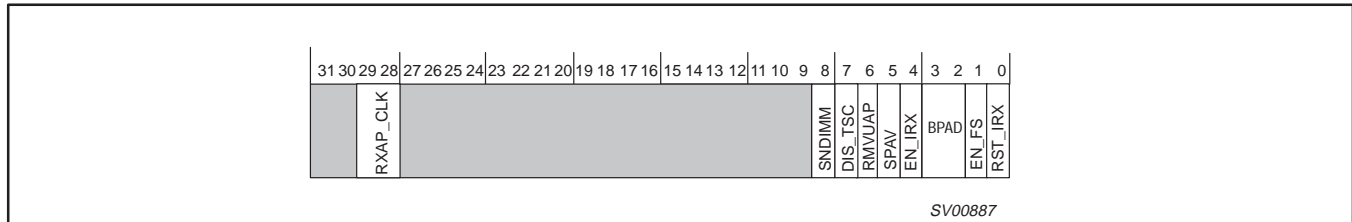

Reset Value 0x00000041

AV Receiver Control Bits.

- Bit 29..28: R/W RXAP_CLK: Receiver Application Clock, default mode, '00' the AVxCLK pin is an input. This pin can become an application clock and output for the isochronous Receiver by programming it to '01', '10', or '11'.
 The programming values are:
 00 Input
 01 24.576MHz
 10 12.288MHz
 11 6.144MHz
 Note that when enabled as '01', '10', or '11', the AV port that is configured as receiver and enabled will output this clock signal on its AVxCLK pin.
- Bit 8: R/W SNDIMM: Send immediately; when set to "1", this bit will allow a received isochronous packet containing a CRC error to be output immediately (without regard to the time stamp value). This bit defaults to "0". In default (reset) mode, the packet will be output with respect to the time stamp value, even if there is a CRC error.
CAUTION: If there is an error in the time stamp, the packet may be held far into the future. This will affect subsequently received packets.
- Bit 7: R/W DIS_TSC: Disable Time Stamp Checking. Defaults to "0", time stamp checking is enabled. When time stamp checking is disabled, the time stamp accompanying a packet is output before the packet to the application for use by the application. This adds an extra quadlet of data to the received data stream; the application must be capable of handling this extra 4 bytes. Note: The term "Time Stamp" used here refers only to source packet header (full quadlet) time stamps; it does not mean SYT field hardware synchronization stamps. Also see ENXTMSTP bit in register X020 for transmit node application time stamp formatting and inputting.
- Bit 6: R/W RMVUAP: Remove unreliable packets from memory, do not attempt delivery
- Bit 5: R SPAV: Source packet available for delivery in buffer memory.
- Bit 4: R/W EN_IRX: Enable receiver operation. Value is only checked whenever a new bus packet arrives, so enable/disable while running is 'graceful', meaning any transfers in process will be completed before this bit is asserted.
- Bit 2..3: R/W BPAD: Value indicating the amount of byte padding to be removed from the last data quadlet of each source packet, from 0 to 3 bytes. This is in addition to quadlet padding as defined in IEC 61883 International Standard.
- Bit 1: R/W EN_FS: Enable processing of SYT stamps.
- Bit 0: R/W RST_IRX: causes the receiver to be reset when '1'. In order for synchronous reset of IRX to work properly, the application must supply an AVCLK and ensure that the reset bit is kept (programmed) HIGH for at least the duration of one AVCLK period. Failure to do so may cause the application interface of this module to be improperly reset (or not reset at all).

1394 full duplex AV link layer controller

PDI1394L21

13.2.9 Common Isochronous Receiver Packet Header Quadlet 1 (IRXHQ1) – Base Address: 0x044

This quadlet represents the last received header value when AV receiver is operating.

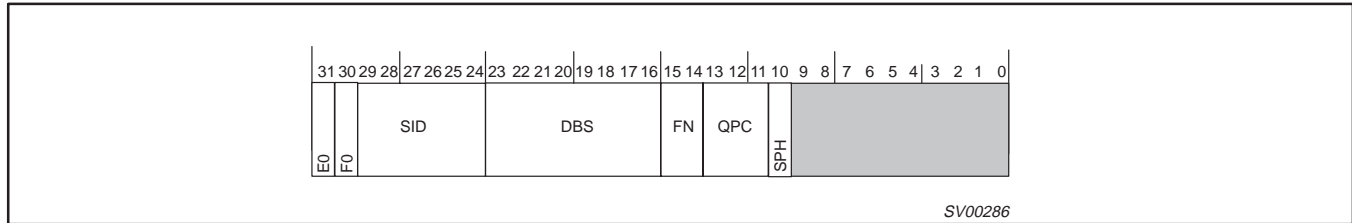

Reset Value 0x00000000

- Bit 31..30: R E0: End of Header, F0: Format: Always set to 00 for first AV header quadlet
- Bit 29..24: R SID: Source ID, contains the node address of the sender of the isochronous data.
- Bit 23..16: R DBS: Size of the data blocks from which AV payload is constructed. The value 0 represents a length of 256 quadlets.
- Bit 15..14: R FN (Fraction Number): The encoding for the number of data blocks into which each source packet has been divided (00 = 1, 01 = 2, 10 = 4, 11 = 8) by the transmitter of the packet.
- Bit 13..11: R QPC: Number of dummy quadlets appended to each source packet before it was divided into data blocks of the specified size.
- Bit 10: R SPH: Indicates that a CYCTM based time stamp is inserted before each application packet (25 bits specified in the IEC 61883 International Standard).

13.2.10 Common Isochronous Receiver Packet Header Quadlet 2 (IRXHQ2) – Base Address: 0x048

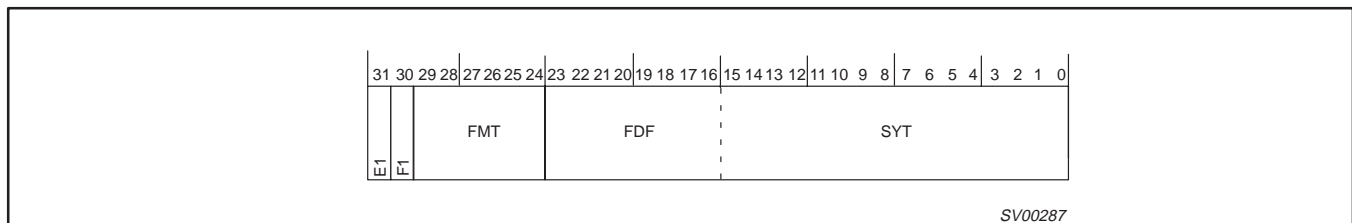

Reset Value 0x0000FFFF

- Bit 31..30: R E1: End of Header, F1: Format: Should be set to 10 for second AV header quadlet.
- Bit 29..24: R FMT: Value inserted in the Format field.
- Bit 23..0: R FDF/SYT: If “EN FS” in Register IRXPKCTL (0x040) is set to ‘1’, then lower 16-bits are interpreted as SYT.

13.2.11 Isochronous Receiver Interrupt Acknowledge (IRXINTACK) – Base Address: 0x04C

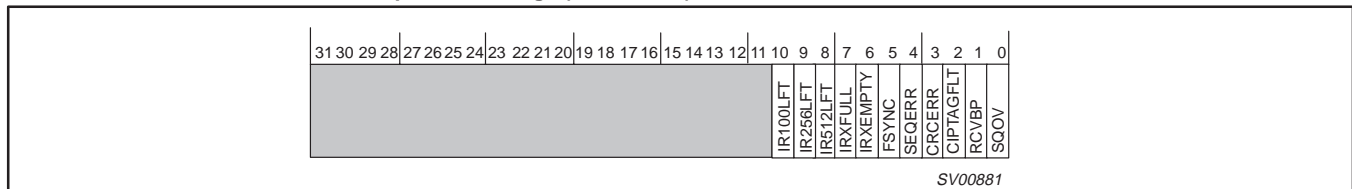

Reset Value 0x00000000

- Bit 10: R/W IR100LFT: Isochronous memory bank is 100 quadlets from full. (924 of 1024 quadlets in queue)
- Bit 9: R/W IR256LFT: Isochronous data memory bank is 256 quadlets from full. (768 of 1024 quadlets are in the queue)
- Bit 8: R/W IR512LFT: Isochronous data memory bank is 50% full. (512 of 1024 quadlets are in the queue)
- Bit 7: R/W IRXFULL: Isochronous data memory bank has become full. This is a fatal error, the recommended action is to reset and re-initialize the receiver.
- Bit 6: R/W IRXEMPTY: Isochronous data memory bank has become empty.
- Bit 5: R/W FSYNC: Pulse at fsync output.
- Bit 4: R/W SEQERR: Sequence error of data blocks.
- Bit 3: R/W CRCERR: CRC error in bus packet.
- Bit 2: R/W CIPTAGFLT: Faulty CIP header tag (E,F bits). i.e.: The CIP header did not meet the standard and the whole packet is ignored.
- Bit 1: R/W RCVBP: Bus packet processing complete.
- Bit 0: R/W SQOV: Status queue overflow. This is a fatal error, the recommended action is to reset and re-initialize the receiver.

1394 full duplex AV link layer controller

PDI1394L21

13.2.12 Isochronous Receiver Interrupt Enable (IRXINTE) – Base Address: 0x050

Interrupt enable bits for AV Receiver.

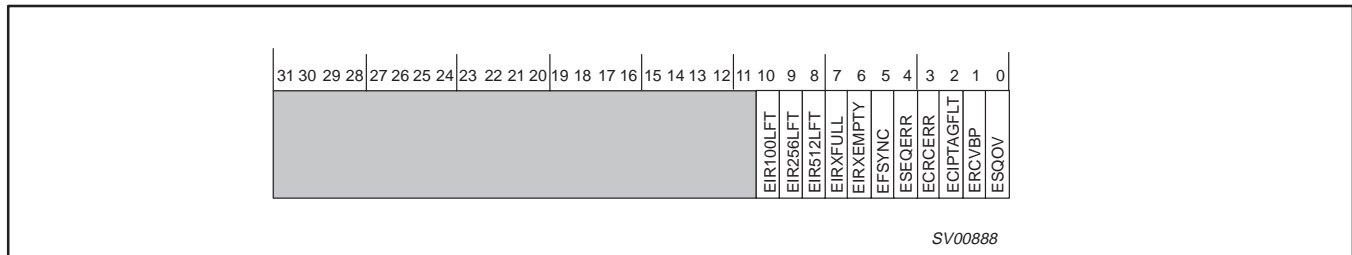

Reset Value 0x00000000

Bit 10..0 are interrupt enable bits for the Isochronous Receiver Interrupt Acknowledge (IRXINTACK).

13.2.13 Isochronous Receiver Control Register (IRXCTL) – Base Address: 0x054

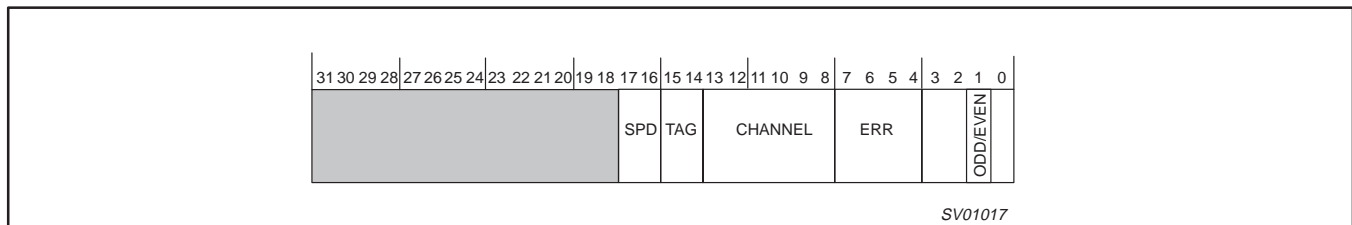

Reset Value 0x00000000

Bit 17..16: R SPD: Speed of last received isochronous packet (S100 .. S400).
 00 = 100 Mbps
 01 = 200 Mbps
 10 = 400 Mbps
 11 = Reserved

Bit 15..14: R/W TAG: Isochronous tag value (must match) for AV format, '01' for IEC 61883 International Standard data.

Bit 13..8: R/W CHAN: Channel number to receive isochronous data.

Bit 7..4: R ERR: Error code for last received isochronous AV packet.

Table 9. Error Codes

Code	Name	Meaning
0000	reserved	
0001	ack_complete	The node has successfully accepted the packet. If the packet was a request subaction, the destination node has successfully completed the transaction and no response subaction shall follow.
0010 through 1100	reserved	
1101	ack_data_error	The node could not accept the block packet because the data field failed the CRC check, or because the length of the data block payload did not match the length contained in the dataLength field. this code shall not be returned for any packet that does not have a data block payload.
1110 and 1111	reserved	

Bit 3..0: R SYNC: Last received SY code in isochronous bus packet header. Bit 1 is odd/even encryption bit key. State of this bit will be outputted at active (receiving) AVPORT on the AVxENKEY pin while the accompanying application packet is being outputted. Also see Section 13.2.6 for a description of the operation of this bit..

1394 full duplex AV link layer controller

PDI1394L21

13.2.14 Isochronous Receiver Memory Status (IRXMEM) – Base Address: 0x058

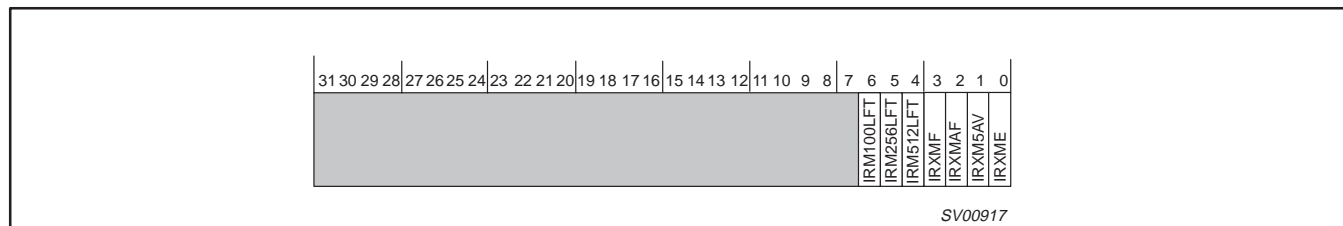

Reset Value 0x00000003

- Bit 6: R IRM100LFT: FIFO is 100 quadlets from full.
- Bit 5: R IRM256LFT: FIFO is 256 quadlets from full.
- Bit 4: R IRM512LFT: FIFO is 1/2 full.
- Bit 3: R IRXMF: Full: no space available.
- Bit 2: R IRXMAF: Almost full: exactly one quadlet of storage available.
- Bit 1: R IRXM5AV: At least 5 more quadlets of storage available.
- Bit 0: R IRXME: Memory bank is empty (no data committed).

1394 full duplex AV link layer controller

PDI1394L21

13.3 Asynchronous Control and Status Interface

13.3.1 Asynchronous RX/TX Control (ASYCTL) – Base Address: 0x080

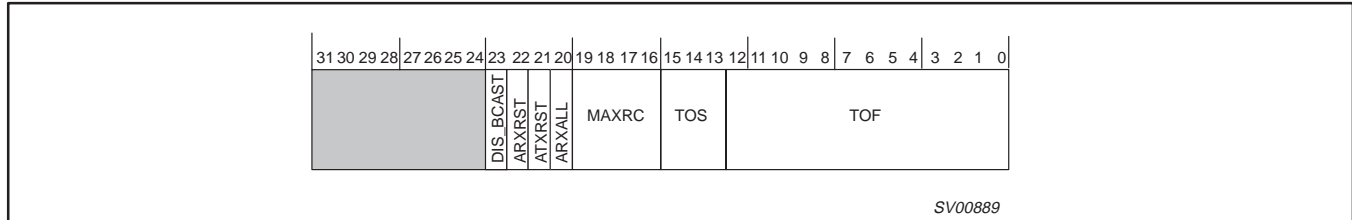

Reset Value 0x00300320

- Bit 23: R/W DIS_BCAST: Disable the reception of broadcast packets.
- Bit 22: R/W ARXRST: Asynchronous receiver reset. This bit will auto clear when the link layer state machine is idle.
- Bit 21: R/W ATXRST: Asynchronous transmitter reset
- Bit 20: R/W ARXALL: Receive and filter only RESPONSE packets. When set (1), all responses are stored. When clear (0), only solicited responses are stored.
- Bit 19..16: R/W MAXRC: Maximum number of asynchronous transmitter single phase retries
- Bit 15..13: R/W TOS: Time out seconds, integer of 1 second of the split transaction time out timer. Resets to "000". This timer is set to the maximum amount of time the transmitter will wait for a pending response before the transmitter will begin transmitting the next available request packet. Also see TOF bits of this timer.
- Bit 12..0: R/W TOF: Time out fractions, integer of 1/8000 second. Resets to 0320h, which is 100 milliseconds. During the timeout of the split transaction timer, subsequent split transactions are blocked. If it is desired to transmit multiple split transactions this can be accomplished by following this procedure: (1) set the split transaction timer value to "0", (2) disable the split time-out interrupt (TIMEOUT, bit 7 in register 0x0A0); (3) clear (set to "0") the unsolicited response filter bit (ARXALL, bit 20 in register 0x080). Now use tLabels (transaction Labels, see section 12.5.1) to pair transmitted packets with received packets. Use software timers to time-out the subsequent pending responses.

13.3.2 Asynchronous RX/TX Memory Status (ASYMEM) – Base Address: 0x084

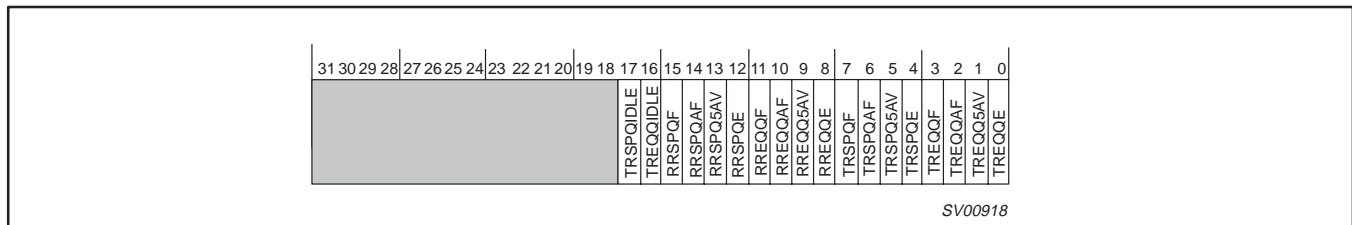

Reset Value 0x00033333

Unused bits read '0'. The information in this register is primarily used for diagnostics.

- Bit 17: R TRSPQIDLE: Transmitter response queue is idle. Indicates that the transfer register for this queue is empty.
- Bit 16: R TREQQIDLE: Transmitter request queue is idle. Indicates that the transfer register for this queue is empty.
- Bit 15: R RRSPQF: Receiver response queue full.
- Bit 14: R RRSPQAF: Receiver response queue almost full (precisely 1 more quadlet available).
- Bit 13: R RRSPQ5AV: Receiver response queue at least 5 quadlets available.
- Bit 12: R RRSPQE: Receiver response queue empty.
- Bit 11: R RREQQF: Receiver request queue full.
- Bit 10: R RREQQAF: Receiver request queue almost full (precisely 1 more quadlet available).
- Bit 9: R RREQQ5AV: Receiver request queue at least 5 quadlets available.
- Bit 8: R RREQQE: Receiver request queue empty.
- Bit 7: R TRSPQF: Transmitter response queue full.
- Bit 6: R TRSPQAF: Transmitter response queue almost full (precisely 1 more quadlet available).
- Bit 5: R TRSPQ5AV: Transmitter response queue at least 5 quadlets available.
- Bit 4: R TRSPQE: Transmitter response queue empty.
- Bit 3: R TREQQF: Transmitter request queue full.
- Bit 2: R TREQQAF: Transmitter request queue almost full (precisely 1 more quadlet available).
- Bit 1: R TREQQ5AV: Transmitter request queue at least 5 quadlets available.
- Bit 0: R TREQQE: Transmitter request queue empty.

1394 full duplex AV link layer controller

PDI1394L21

13.3.3 Asynchronous Transmit Request Next (TX_RQ_NEXT) – Base Address: 0x088

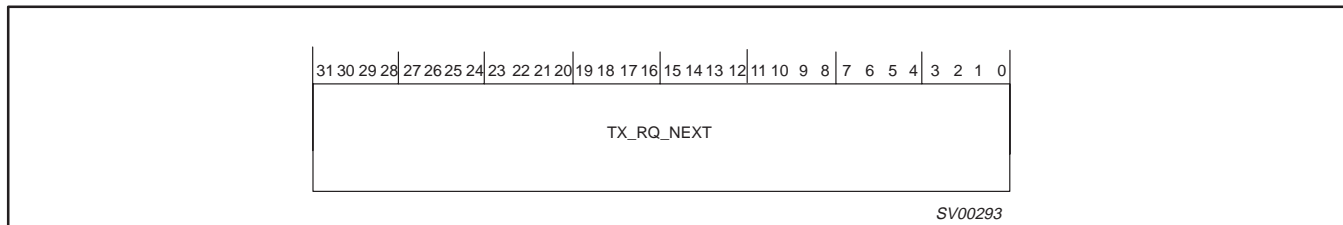

Bit 31..0: W TX_RQ_NEXT: First/middle quadlet of packet for transmitter request queue (write only).
 Writing this register will clear the TREQQWR flag until the quadlet has been written to its queue.

13.3.4 Asynchronous Transmit Request Last (TX_RQ_LAST) – Base Address: 0x08C

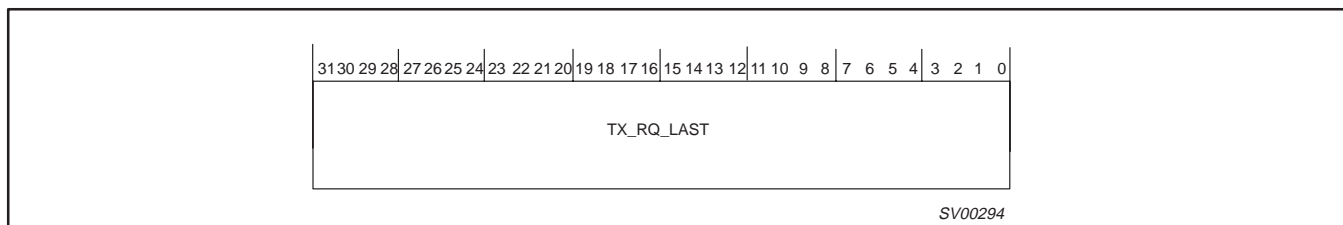

Bit 31..0: W TX_RQ_LAST: Last quadlet of packet for transmitter request queue (write only).
 Writing this register will clear the TREQQWR flag until the quadlet has been written to its queue.

13.3.5 Asynchronous Transmit Response Next (TX_RP_NEXT) – Base Address: 0x090

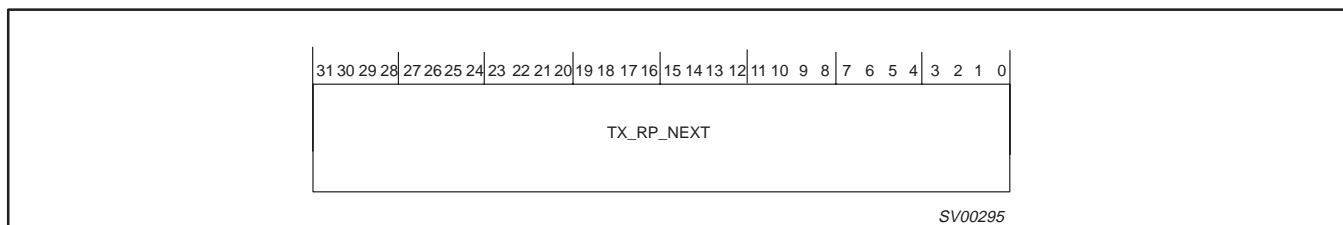

Bit 31..0: W TX_RP_NEXT: First/middle quadlet of packet for transmitter response queue (write only).
 Writing this register will clear the TRSPQWR flag until the quadlet has been written to its queue.

13.3.6 Asynchronous Transmit Response Last (TX_RP_LAST) – Base Address: 0x094

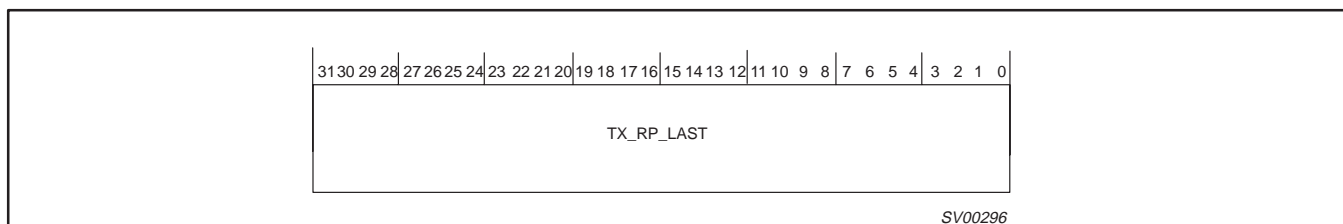

Bit 31..0: W TX_RP_LAST: Last quadlet of packet for transmitter response queue (write only).
 Writing this register will clear the TRSPQWR flag until the quadlet has been written to its queue.

1394 full duplex AV link layer controller

PDI1394L21

13.3.7 Asynchronous Receive Request (RREQ) – Base Address: 0x098

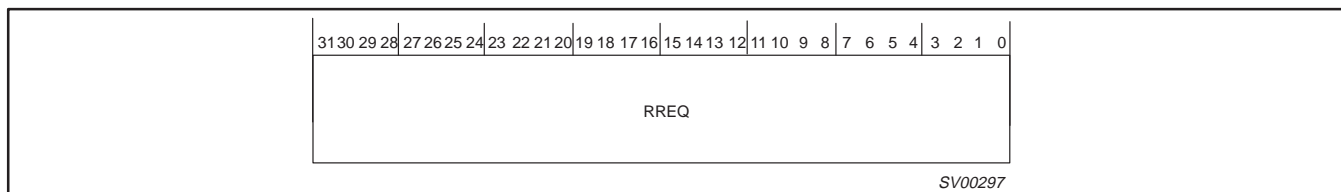

Reset Value 0x00000000

Bit 31..0: R RREQ:Quadlet of packet from receiver request queue (transfer register).
Reading this register will clear the RREQQAV flag until the next received quadlet is available for reading.

13.3.8 Asynchronous Receive Response (RRSP) – Base Address: 0x09C

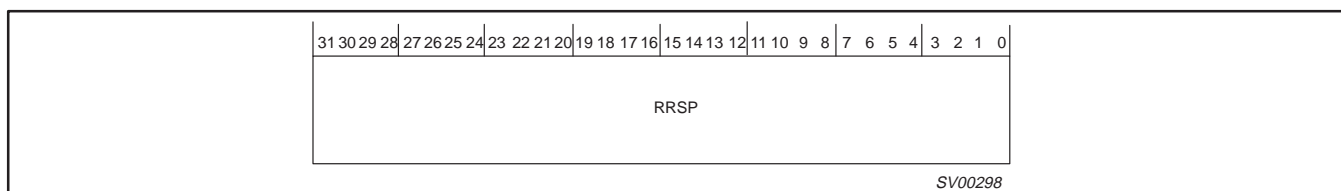

Reset Value 0x00000000

Bit 31..0: R RRSP:Quadlet of packet from receiver response queue (transfer register).
Reading this register will clear the RRSPQAV flag until the next received quadlet is available for reading.

13.3.9 Asynchronous RX/TX Interrupt Acknowledge (ASYINTACK) – Base Address: 0x0A0

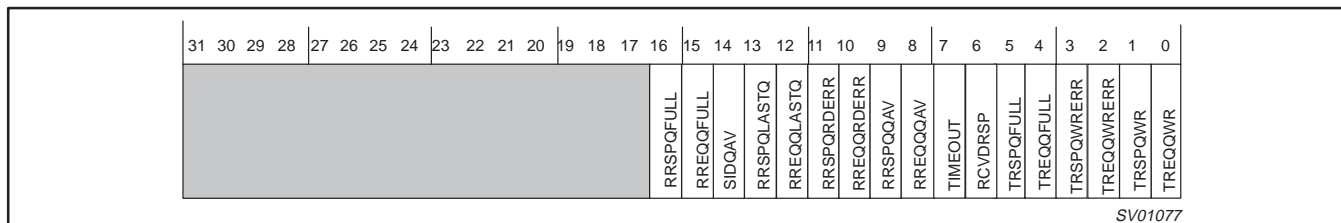

Reset Value 0x00000C00

- Bit 31..17: R/W Unused bits read '0'
- Bit 16: R/W RRSPQFULL: Receiver response queue did become full. Write a "1" to this bit to reset the interrupt.
- Bit 15: R/W RREQQFULL: Receiver request queue did become full. Write a "1" to this bit to reset the interrupt.
- Bit 14: R/W SIDQAV: Current quadlet in RREQ is self ID data. This bit is set only after a bus reset, not after reception of PHY packets other than self IDs. This interrupt automatically resets when the quadlet is read.
- Bit 13: R/W RRSPQLASTQ: Current quadlet in RRSP is last quadlet of packet. This interrupt automatically resets when the quadlet is read.
- Bit 12: R/W RREQQLASTQ: Current quadlet in RREQ is last quadlet of packet. This interrupt automatically resets when the quadlet is read.
- Bit 11: R/W RRSPQRDERR: Receiver response queue read error (transfer error) or bus reset occurred. When set (1), this queue is blocked for read access. Write a "1" to this bit to reset the interrupt.
- Bit 10: R/W RREQQRDERR: Receiver request queue read error (transfer error) or bus reset occurred. When set (1), this queue is blocked for read access. Write a "1" to this bit to reset the interrupt.
- Bit 9: R/W RRSPQQAV: Receiver response queue quadlet available (in RRSP). This interrupt automatically resets when the quadlet is read.
- Bit 8: R/W RREQQQAV: Receiver request queue quadlet available (in RREQ). This interrupt automatically resets when the quadlet is read.
- Bit 7: R/W TIMEOUT: Split transaction response timeout. Write a "1" to this bit to reset the interrupt.
- Bit 6: R/W RCVDRSP: Solicited response received (within timeout interval). Write a "1" to this bit to reset the interrupt.
- Bit 5: R/W TRSPQFULL: Transmitter response queue did become full. Write a "1" to this bit to reset the interrupt.
- Bit 4: R/W TREQQFULL: Transmitter request queue did become full. Write a "1" to this bit to reset the interrupt.
- Bit 3: R/W TRSPQWRERR: Transmitter response queue write error (transfer error). Write a "1" to this bit to reset the interrupt.
- Bit 2: R/W TREQQWRERR: Transmitter request queue write error (transfer error). Write a "1" to this bit to reset the interrupt.
- Bit 1: R/W TRSPQWR: Transmitter response queue written (transfer register emptied). Write a "1" to this bit to reset the interrupt.

1394 full duplex AV link layer controller

PDI1394L21

Bit 0: R/W TREQQWR: Transmitter request queue written (transfer register emptied). Write a "1" to this bit to reset the interrupt.

13.3.10 Asynchronous RX/TX Interrupt Enable (ASYINTE) – Base Address: 0x0A4

31	30	29	28	27	26	25	24	23	22	21	20	19	18	17	16	15	14	13	12	11	10	9	8	7	6	5	4	3	2	1	0	
																ERRSPOFULL	ERREQFULL	ESIDQAV	ERRSPOLASTQ	ERREQOLASTQ	ERRSPORDERR	ERREQORDERR	ERRSPQAV	ERREQQAV	ETIMOUT	ERCVDRSP	ETRSPOFULL	ETREQFULL	ETRSPOWRERR	ETREQWRERR	ETRSPOWR	ETREQWR

SV00797

Reset Value 0x00000000

Bits16..0 are interrupt enable bits for the Asynchronous RX/TX Interrupt Acknowledge (ASYINTACK).

14.0 DC ELECTRICAL CHARACTERISTICS

Table 10. DC Electrical Characteristics

SYMBOL	PARAMETER	MIN	MAX	UNIT	NOTE
V _{IL}	LOW input voltage		0.8	V	Pin categories 1, 2, 3
V _{IH}	HIGH input voltage	2.0		V	Pin categories 1, 2, 3
V _{IT1+}	Input threshold, rising edge	V _{DD} /2 + 0.3	V _{DD} /2 + 0.9	V	Pin categories 6, 8 LOW to HIGH transition
V _{IT1-}	Input threshold, falling edge	V _{DD} /2 - 0.9	V _{DD} /2 - 0.3	V	Pin categories 6, 8 HIGH to LOW transition
V _{OH1}	HIGH output voltage	2.4		V	Pin category 1 I _{OH} = 8mA I _{OL} = 8mA
V _{OL1}	LOW output voltage		0.4	V	Pin category 1 I _{OH} = 8mA I _{OL} = 8mA
V _{OH2}	HIGH output voltage	2.4		V	Pin categories 4, 6, 7 I _{OH} = 4mA
V _{OL2}	LOW output voltage		0.4	V	Pin categories 4, 5, 6, 7 I _{OL} = 4mA
I _L	Input leakage current		±1	µA	Pin categories 1, 2, 3 V _I = 5.5V or 0V
			200	µA	Pin category 8 V _I = 5.5V or 0V
I _{OZ}	3-State output current		±5	µA	Pin categories 1, 7 V _I = 5.5V or 0V
			200	µA	Pin category 6 V _I = 5.5V or 0V
I _{DD}	Active supply current		75	mA	Under idle conditions, the average value is 15 mA

1394 full duplex AV link layer controller

PDI1394L21

14.1 Pin Categories

Table 11. Pin Categories

Category 1: Input/Output	Category 2: Input	Category 3: Input	Category 4: Output	Category 5: Output	Category 6: Input/Output	Category 7:	Category 8:
HIF D[7:0]	HIF A[8:0]	RESET_N	CYCLEOUT	HIF INT_N	PHY D[0:7]	LREQ	SCLK
AVxSYNC	HIF CS_N	CYCLEIN	AVxERR0		PHY CTL[0:1]		
AVxVALID	HIF WR_N	ISO_N	AVxERR1				
AV xD[7:0]	HIF RD_N		CLK25				
AVxENKEY	AVxENDPCK						
AVxCLK							
AVxFSYNC							

15.0 AC CHARACTERISTICS

GND = 0V, C_L = 50pF

SYMBOL	PARAMETER	TEST CONDITIONS	WAVEFORMS	LIMITS			UNIT
				T _{amb} = 0°C to +70°C			
				MIN	TYP	MAX	
t _{PERIOD}	AV clock period		Figure 26	41.67			ns
t _{SU}	AV clock setup time		Figure 26	20			ns
t _{IH}	AV clock input hold time		Figure 26	3			ns
t _{OD}	AV clock output delay time		Figure 26	3		24	ns
t _{WHIGH}	AV clock pulse width HIGH		Figure 26	10			
t _{WLOW}	AV clock pulse width LOW		Figure 26	10			
t _{PWFS}	AVxFSYNC pulse width HIGH		Figure 27	100		140	ns
t _{SUP}	PHY-link setup time		Figure 28	6.0			ns
t _{HP}	PHY-link hold time		Figure 28	0			ns
t _{SCLKPER}	SCLK period		Figure 28	20.343	20.345	20.347	ns
t _{DP}	PHY-link output delay	Note: C _L = 20pF	Figure 29	2.0		10.0	ns
t _{AS}	Host address setup time		Figure 30	0			ns
t _{AH}	Host address hold time		Figure 30	0			ns
t _{CL}	Host chip select pulse width LOW		Figure 30	115			ns
t _{CH}	Host chip select pulse width HIGH		Figure 30	42			ns
t _{RP}	Host read pulse width		Figure 30	115			ns
t _{ACC}	Host access time		Figure 30			115	ns
t _{DH}	Host data hold time		Figure 30	0			ns
t _{DS}	Host data setup time		Figure 30	0			ns
t _{DZ}	Host data bus release (Hi-Z)		Figure 30			15	ns
t _{WRP}	Host write pulse width		Figure 30	115			ns
t _{CWH}	CYCLEIN HIGH pulse width		Figure 31	200			ns
t _{CWL}	CYCLEIN LOW pulse width		Figure 31	200			ns
t _{CP}	CYCLEIN cycle period		Figure 31	125			μs
t _{CD}	CYCLEOUT cycle delay		Figure 32			20	ns
t _{RESET}	RESET_N pulse width LOW		Figure 33	10			μs

1394 full duplex AV link layer controller

PDI1394L21

16.0 TIMING DIAGRAMS

16.1 AV Interface Operation

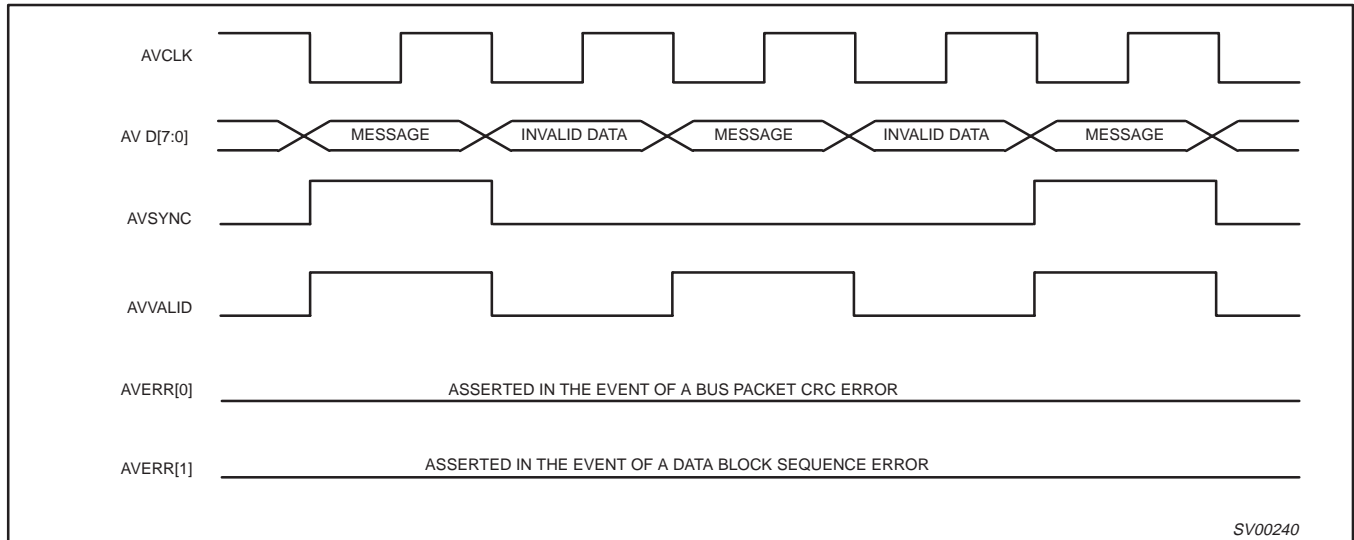

Figure 25. AV Interface Operation Diagram

16.2 AV Interface Critical Timings

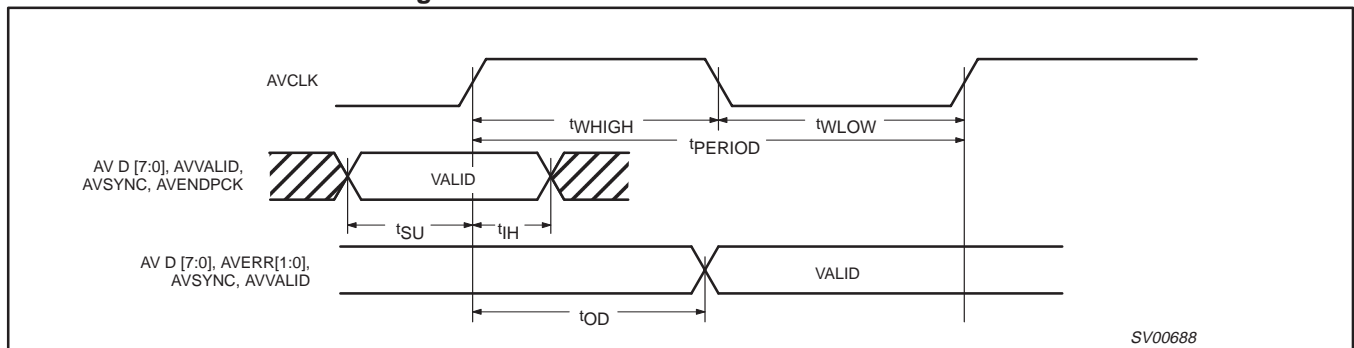

Figure 26. AV Interface Timing Diagram

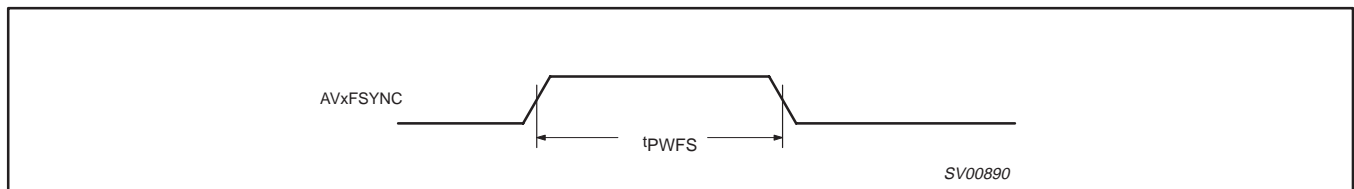

Figure 27. AVxFSYNC Timing Diagram

1394 full duplex AV link layer controller

PDI1394L21

16.3 PHY-Link Interface Critical Timings

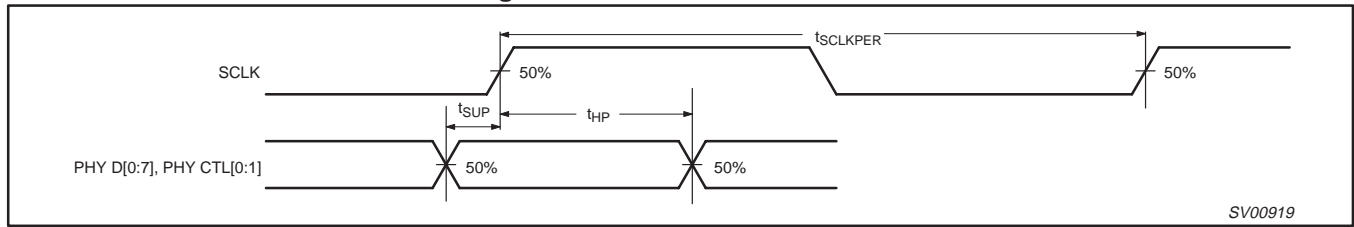

Figure 28. PHY D[0:7], PHY CTL[0:1] Input Setup and Hold Timing Waveforms

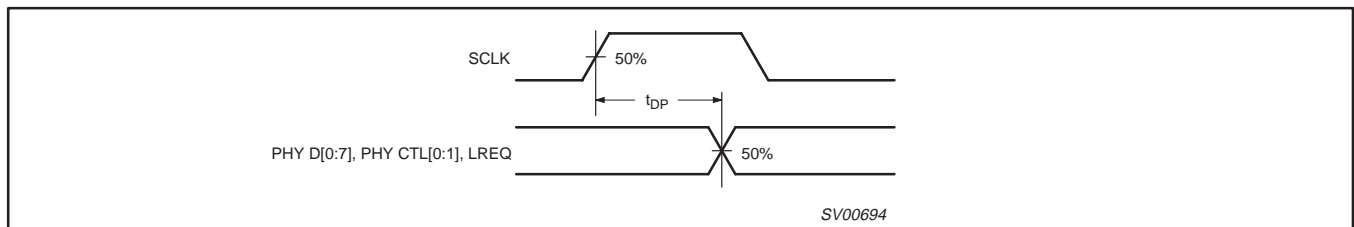

Figure 29. PHY D[0:7], PHY CTL[0:1], and LREQ Output-Delay Timing Waveforms

16.4 Host Interface Critical Timings

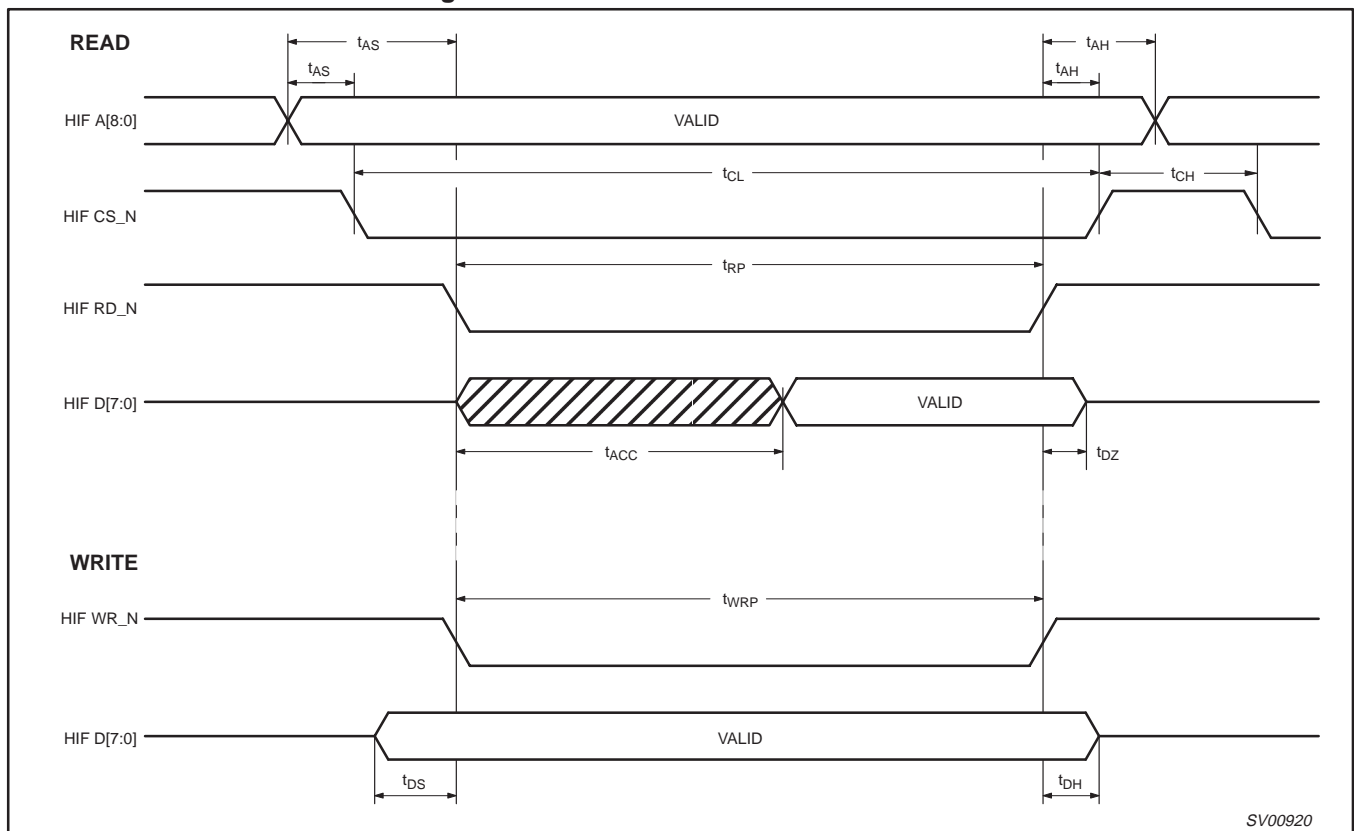

Figure 30. Host Interface Timing Waveforms

1394 full duplex AV link layer controller

PDI1394L21

16.5 CYCLEIN/CYCLEOUT Timings

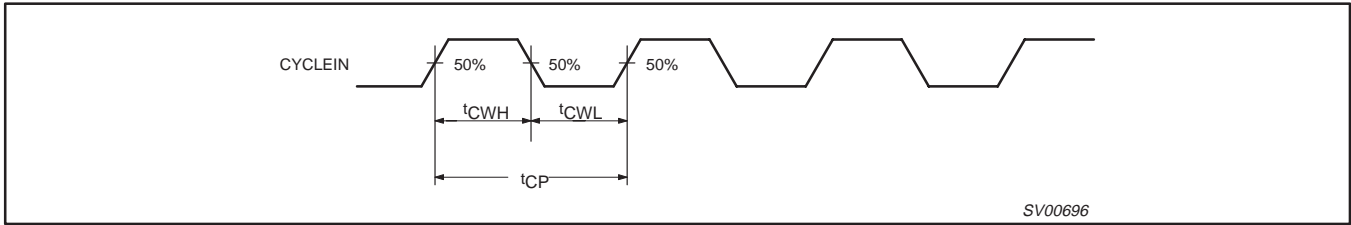

Figure 31. CYCLEIN Waveform

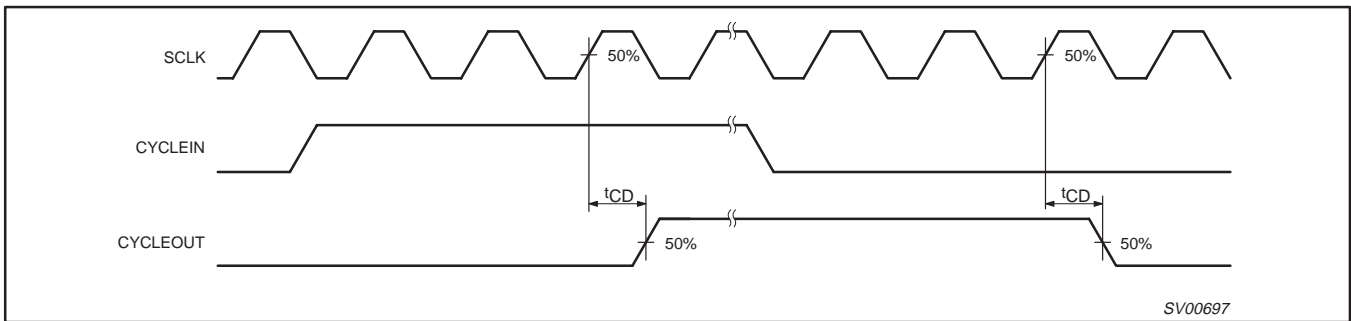

Figure 32. CYCLEOUT Waveforms

16.6 RESET Timings

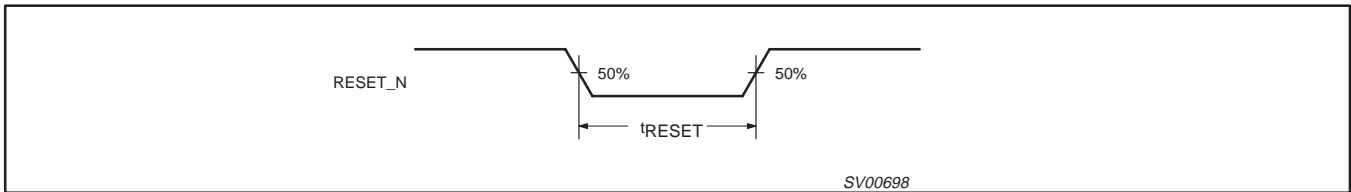

Figure 33. RESET_N Waveform

1394 full duplex AV link layer controller

PDI1394L21

TQFP100: plastic thin quad flat package; 100 leads; body 14 x 14 x 1.0 mm

SOT386-1

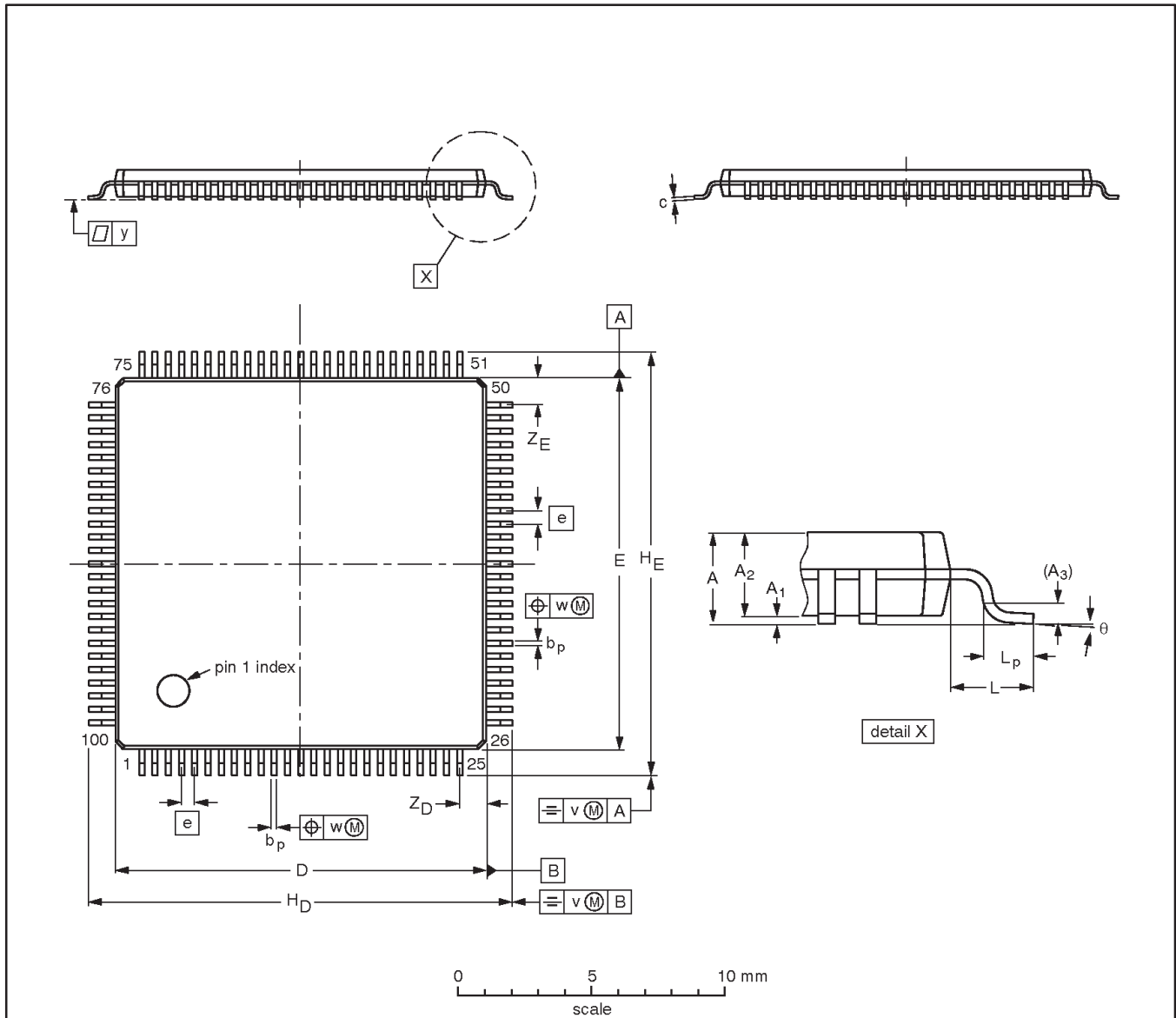

DIMENSIONS (mm are the original dimensions)

UNIT	A max.	A ₁	A ₂	A ₃	b _p	c	D ⁽¹⁾	E ⁽¹⁾	e	H _D	H _E	L	L _p	v	w	y	Z _D ⁽¹⁾	Z _E ⁽¹⁾	θ
mm	1.2	0.15 0.05	1.05 0.95	0.25	0.27 0.17	0.18 0.12	14.1 13.9	14.1 13.9	0.5	16.15 15.85	16.15 15.85	1.0	0.75 0.45	0.2	0.08	0.1	1.15 0.85	1.15 0.85	7° 0°

Note

1. Plastic or metal protrusions of 0.25 mm maximum per side are not included.

OUTLINE VERSION	REFERENCES				EUROPEAN PROJECTION	ISSUE DATE
	IEC	JEDEC	EIAJ			
SOT386-1						96-04-02 97-08-04

1394 full duplex AV link layer controller

PDI1394L21

LQFP100: plastic low profile quad flat package; 100 leads; body 14 x 14 x 1.4 mm

SOT407-1

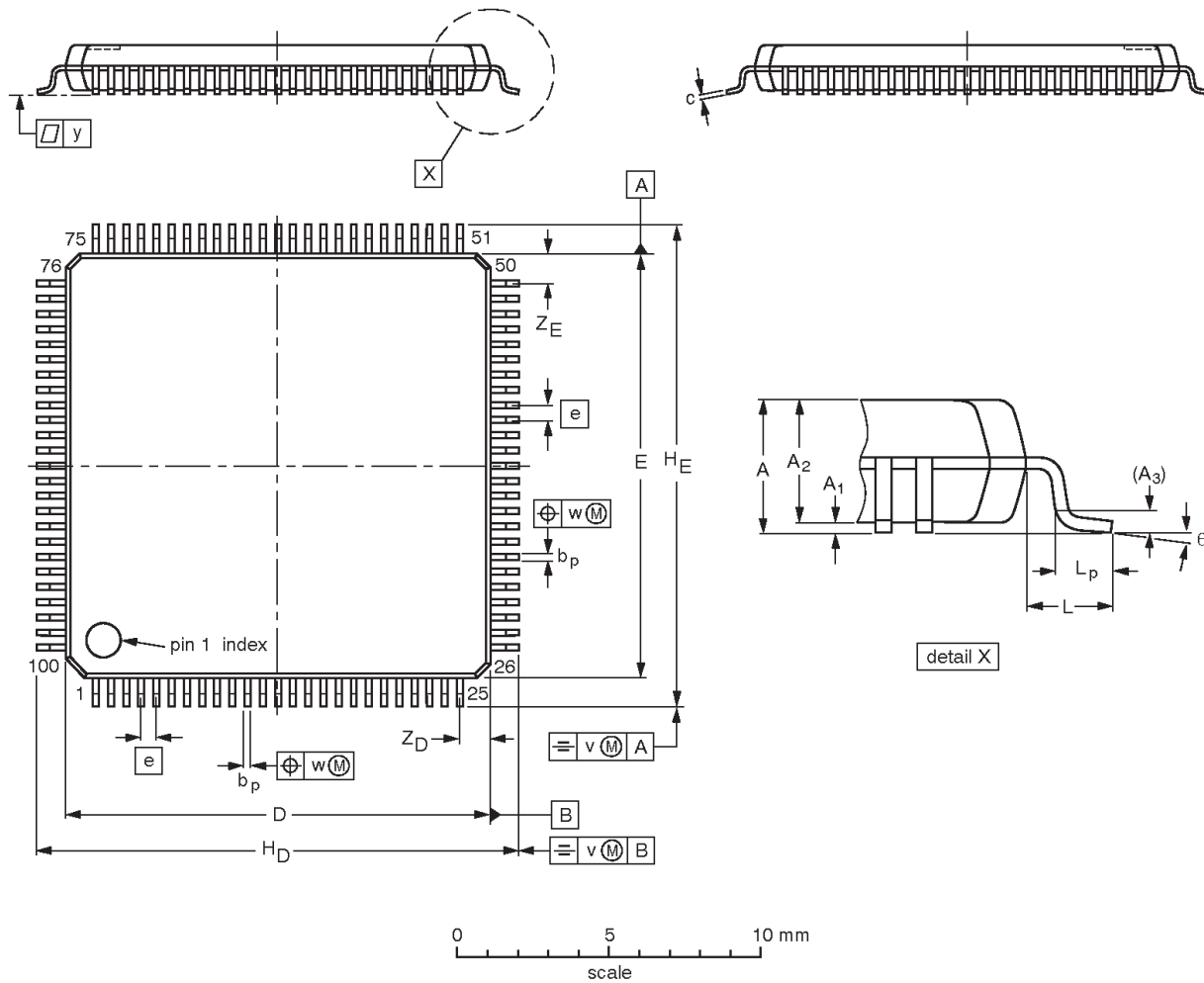

DIMENSIONS (mm are the original dimensions)

UNIT	A max.	A ₁	A ₂	A ₃	b _p	c	D ⁽¹⁾	E ⁽¹⁾	e	H _D	H _E	L	L _p	v	w	y	Z _D ⁽¹⁾	Z _E ⁽¹⁾	θ
mm	1.6	0.20 0.05	1.5 1.3	0.25	0.28 0.16	0.18 0.12	14.1 13.9	14.1 13.9	0.5	16.25 15.75	16.25 15.75	1.0	0.75 0.45	0.2	0.12	0.1	1.15 0.85	1.15 0.85	7° 0°

Note

1. Plastic or metal protrusions of 0.25 mm maximum per side are not included.

OUTLINE VERSION	REFERENCES				EUROPEAN PROJECTION	ISSUE DATE
	IEC	JEDEC	EIAJ			
SOT407-1						95-12-19 97-08-04

ERRATA LIST FOR THE PHILIPS PDI1394L21 1394 FULL DUPLEX AV LINK LAYER CONTROLLER

(These errata refer to the data sheet dated 1999 August 6)

Chip Errata:

E-1. Self-ID Packet Issues:

Description of expected operation: After bus reset, the queues are flushed and a self-ID packet should be placed in the Read Request Queue. Refer to section 12.5.2.4 (Self-ID and PHY packets receive) in the “PDI1394L21 1394 Full Duplex AV Link Layer Controller” data sheet for the proper format of a self-ID packet.

Description of observed behavior: Occasionally 0x000000E0 and 0x00000010 quadlets are found in the Read Request Queue with no accompanying self-ID and acknowledge quadlet. This type of self-ID is valid ONLY for a node which is not connected to any other node (node standing alone). This partial self-ID packet results from a recent node connection (hot plug) event or Link/PHY hardware reset.

Solution or work around: Issue a software bus reset and read the self IDs generated by that reset.

E-2. AVFSYNC pin function at high FSYNC pulse repetition rates:

Description of expected operation: With the EN_FS bits set on the isochronous transmitter of the transmitting node and the isochronous receiver of the receiving node, a pulse introduced at the FSYNC pin on the transmitting AV port of the transmitting node will produce an SYT field time stamp in the next bus packet which will, in turn, produce a pulse at the FSYNC pin of the receiving AV port on the receiving node at a time corresponding to the expiration of the SYT field time stamp, with the SYT Delay introduced at the transmitter taken into account.

Description of observed behavior: At rep rates below 2 KHz, the system works as expected. At rep rates greater than 2 KHz (dependant upon the setting of the SYT Delay bits) the system operates as expected for a short period of time (about 100 milliseconds), then operates erratically thereafter.

Solution or work around: Do not use above the following rep rates with the corresponding SYT Delay settings: SYT Delay = 2 bus cycles, maximum rep rate = 3,200; SYT Delay = 3 bus cycles, maximum rep rate = 3,200; SYT Delay = 4 bus cycles, maximum rep rate = 4,200.

E-3. AVENKEY pin function:

Description of expected operation: This pin / function is intended to attach a specific “key” state to each byte of a transmitted isochronous packet by means of reading the ENKEY pin on the transmitting AV port while the first byte of an application packet is being inputted. The ENKEY state of the first inputted byte is the state of all packet bytes.

Description of observed behavior: Unless the state of the ENKEY pin is inputted within a certain part of the link internal clock cycle, occasionally some of the bytes in a packet are keyed with the wrong state. This results in packets getting “stuck” in the isochronous transmit FIFO and causing FIFO overflow.

Solution or work around: Input key states only with reference to the CLK25 signal of the link chip to assure proper synchronization. The AVCLK signal must rise 8 to 41 nS before the CLK25 signal rises for proper operation at 12.288 MHz. It is the AVCLK signal which introduces the state of the ENKEY pin (and all others) to the AV port interface logic. Please consult Philips IEEE 1394 Applications Engineering Group (1394@philips.com) for use of this function at other AVCLK frequencies.

1394 full duplex AV link layer controller

PDI1394L21

Data sheet status

Data sheet status	Product status	Definition [1]
Objective specification	Development	This data sheet contains the design target or goal specifications for product development. Specification may change in any manner without notice.
Preliminary specification	Qualification	This data sheet contains preliminary data, and supplementary data will be published at a later date. Philips Semiconductors reserves the right to make changes at any time without notice in order to improve design and supply the best possible product.
Product specification	Production	This data sheet contains final specifications. Philips Semiconductors reserves the right to make changes at any time without notice in order to improve design and supply the best possible product.

[1] Please consult the most recently issued datasheet before initiating or completing a design.

Definitions

Short-form specification — The data in a short-form specification is extracted from a full data sheet with the same type number and title. For detailed information see the relevant data sheet or data handbook.

Limiting values definition — Limiting values given are in accordance with the Absolute Maximum Rating System (IEC 134). Stress above one or more of the limiting values may cause permanent damage to the device. These are stress ratings only and operation of the device at these or at any other conditions above those given in the Characteristics sections of the specification is not implied. Exposure to limiting values for extended periods may affect device reliability.

Application information — Applications that are described herein for any of these products are for illustrative purposes only. Philips Semiconductors make no representation or warranty that such applications will be suitable for the specified use without further testing or modification.

Disclaimers

Life support — These products are not designed for use in life support appliances, devices or systems where malfunction of these products can reasonably be expected to result in personal injury. Philips Semiconductors customers using or selling these products for use in such applications do so at their own risk and agree to fully indemnify Philips Semiconductors for any damages resulting from such application.

Right to make changes — Philips Semiconductors reserves the right to make changes, without notice, in the products, including circuits, standard cells, and/or software, described or contained herein in order to improve design and/or performance. Philips Semiconductors assumes no responsibility or liability for the use of any of these products, conveys no license or title under any patent, copyright, or mask work right to these products, and makes no representations or warranties that these products are free from patent, copyright, or mask work right infringement, unless otherwise specified.

Philips Semiconductors
811 East Arques Avenue
P.O. Box 3409
Sunnyvale, California 94088-3409
Telephone 800-234-7381

© Copyright Philips Electronics North America Corporation 1999
All rights reserved. Printed in U.S.A.

Date of release: 08-99

Document order number:

9397 750 05512

Let's make things better.