

# 0.3mmPitch FPC Connectors

## FF12 Series



RoHS Compliant

### Application

Mobile Phones, Digital Cameras, PDA,  
Notebook Computers, DVD,LCD Connection,  
Plasm Display,MP-3 Player Other  
Hand- held Devices

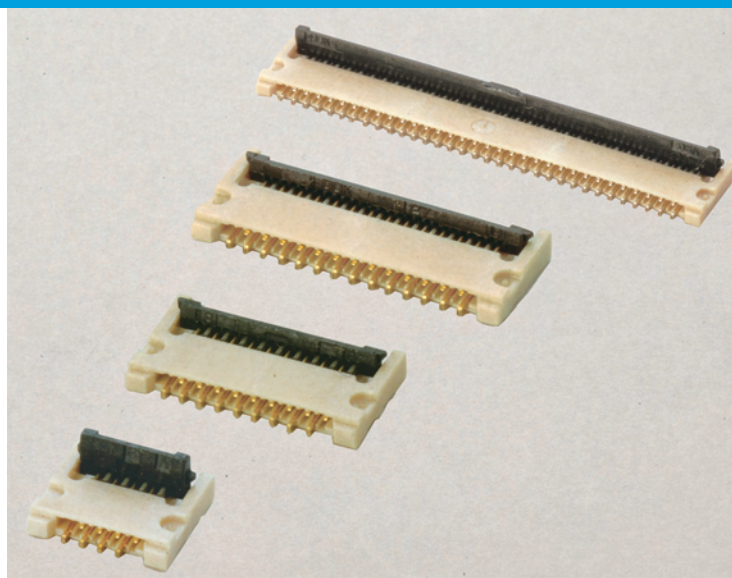

### Features

1. Both of upper and lower contact in one connector.
2. Space saving design with 0.9mm high and miniaturized the connector occupies.
3. Rotation back slider with cam  
Reliable electrical connection and easy FPC insertion.
4. Low insertion force  
Protects to be shifted after FPC insertion.
5. Available to space saving slider or easy operation slider.

\* : Please do not close a Lock lever at the state of FPC un` inserting.

### Specifications

- Rated voltage : 50V AC(r.m.s.)
- Rated current : 0.2A / Contact
- Dielectric withstanding voltage : 200V AC(r.m.s.) for 1 minute
- Insulation resistance : 50M $\Omega$  min. at 250V DC
- Contact resistance : 50m $\Omega$  max.

### Material / Finish

Contact : Copper Alloy / Flash Gold Plating over Nickel Plating  
Housing : LCP resin (UL94V-0) / Ivory  
Slider : PPS resin (UL94V-0) / Black

Eco/FF-E-02

Unit:mm

FF12-□□A-R1□A

Number of contact

Contact Finish  
1 : Gold over Nickel plating

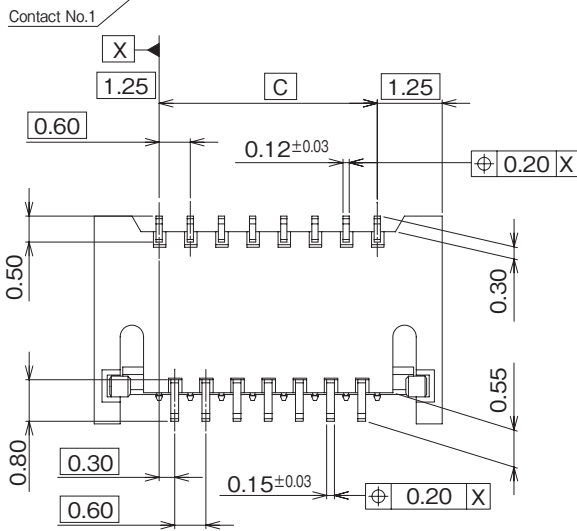
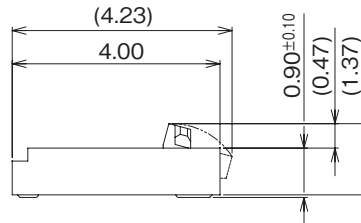
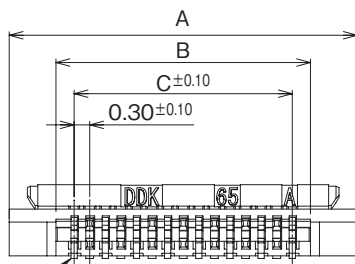
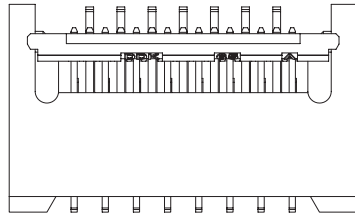

P/N	Number of contact	A	B	C	D
FF12- 8A-R1□A	8	4.60	2.80	2.10	2.70
FF12-10A-R1□A	10	5.20	3.40	2.70	3.30
FF12-12A-R1□A	12	5.80	4.00	3.30	3.90
FF12-13A-R1□A	13	6.10	4.30	3.60	4.20
FF12-17A-R1□A	17	7.30	5.50	4.80	5.40
FF12-18A-R1□A	18	7.60	5.80	5.10	5.70
FF12-22A-R1□A	22	8.80	7.00	6.30	6.90
FF12-23A-R1□A	23	9.10	7.30	6.60	7.20
FF12-25A-R1□A	25	9.70	7.90	7.20	7.80
FF12-27A-R1□A	27	10.30	8.50	7.80	8.40
FF12-29A-R1□A	29	10.90	9.10	8.40	9.00
FF12-32A-R1□A	32	11.80	10.00	9.30	9.90
FF12-33A-R1□A	33	12.10	10.30	9.60	10.20
FF12-39A-R1□A	39	13.90	12.10	11.40	12.00

Unit:mm

## FF12-□□A-R1□B

Number of contact

Contact Finish  
1 : Gold over Nickel plating

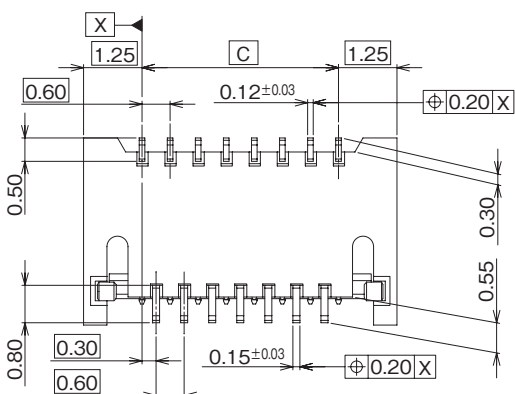
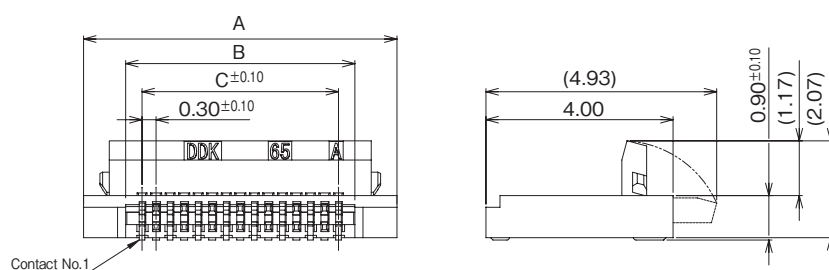
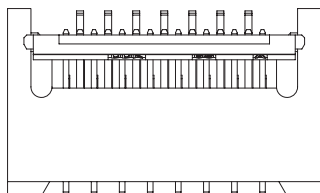

P / N	Number of contact	A	B	C	D
FF12- 8A-R1□B	8	4.60	2.80	2.10	2.70
FF12-12A-R1□B	12	5.80	4.00	3.30	3.90
FF12-17A-R1□B	17	7.30	5.50	4.80	5.40
FF12-21A-R1□B	21	8.50	6.70	6.00	6.60
FF12-22A-R1□B	22	8.80	7.30	6.30	6.90
FF12-23A-R1□B	23	9.10	7.00	6.60	7.20
FF12-25A-R1□B	25	9.70	7.90	7.20	7.80
FF12-27A-R1□B	27	10.30	8.50	7.80	8.40
FF12-29A-R1□B	29	10.90	9.10	8.40	9.00
FF12-32A-R1□B	32	11.80	10.00	9.30	9.90
FF12-33A-R1□B	33	12.10	10.30	9.60	10.20
FF12-34A-R1□B	34	12.40	10.60	9.90	10.50
FF12-35A-R1□B	35	12.70	10.90	10.20	10.80
FF12-39A-R1□B	39	13.90	12.10	11.40	12.00
FF12-45A-R1□B	45	15.70	13.90	13.20	13.80
FF12-51A-R1□B	51	17.50	15.70	15.00	15.60

## ■PCB Mounting Dimensions

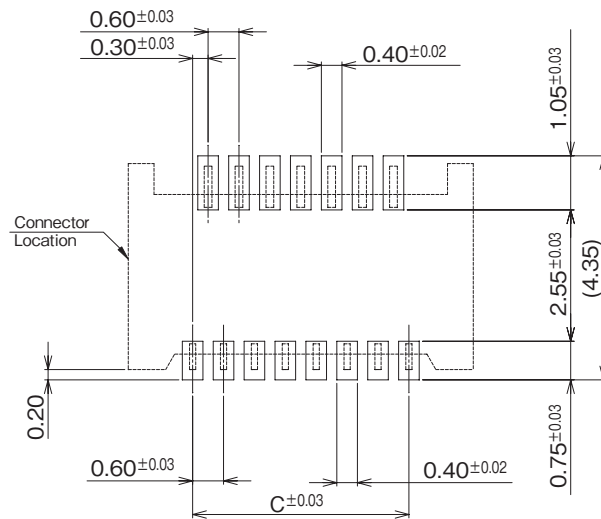

## ■FPC Dimensions

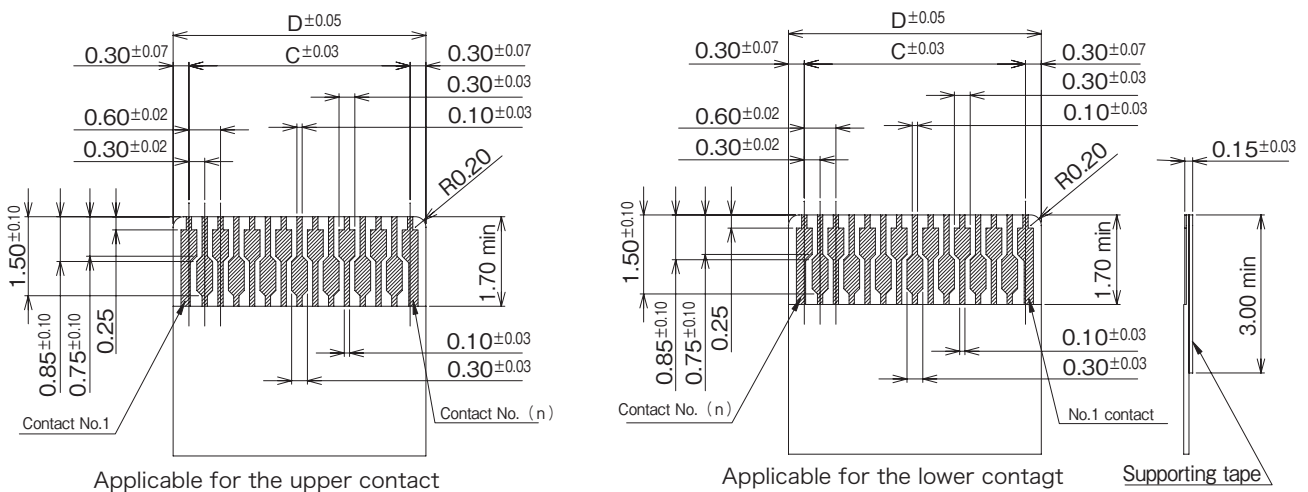

### Applicable for the Odd number contacts

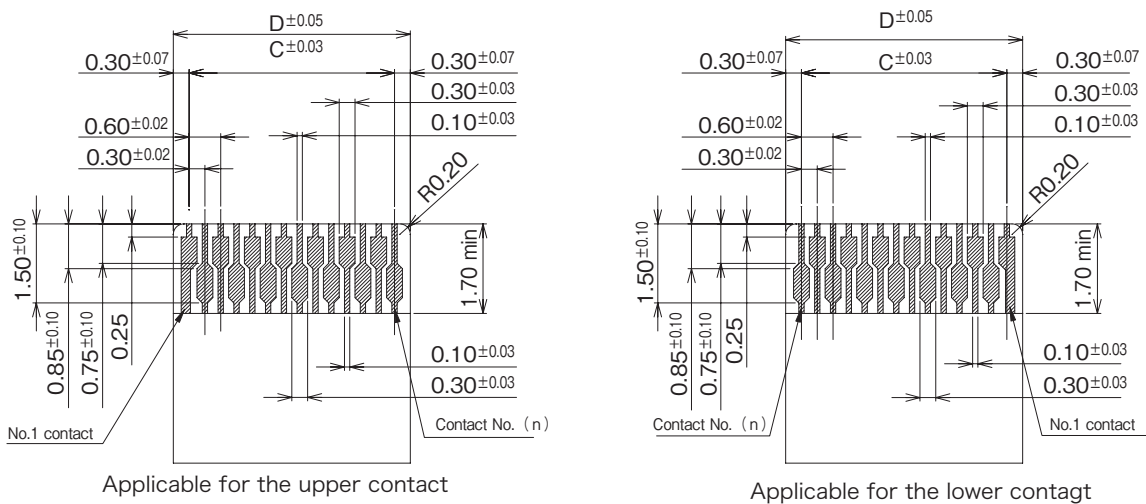

### Applicable for the Even number contacts

Unit:mm

## ■Reel Dimensions

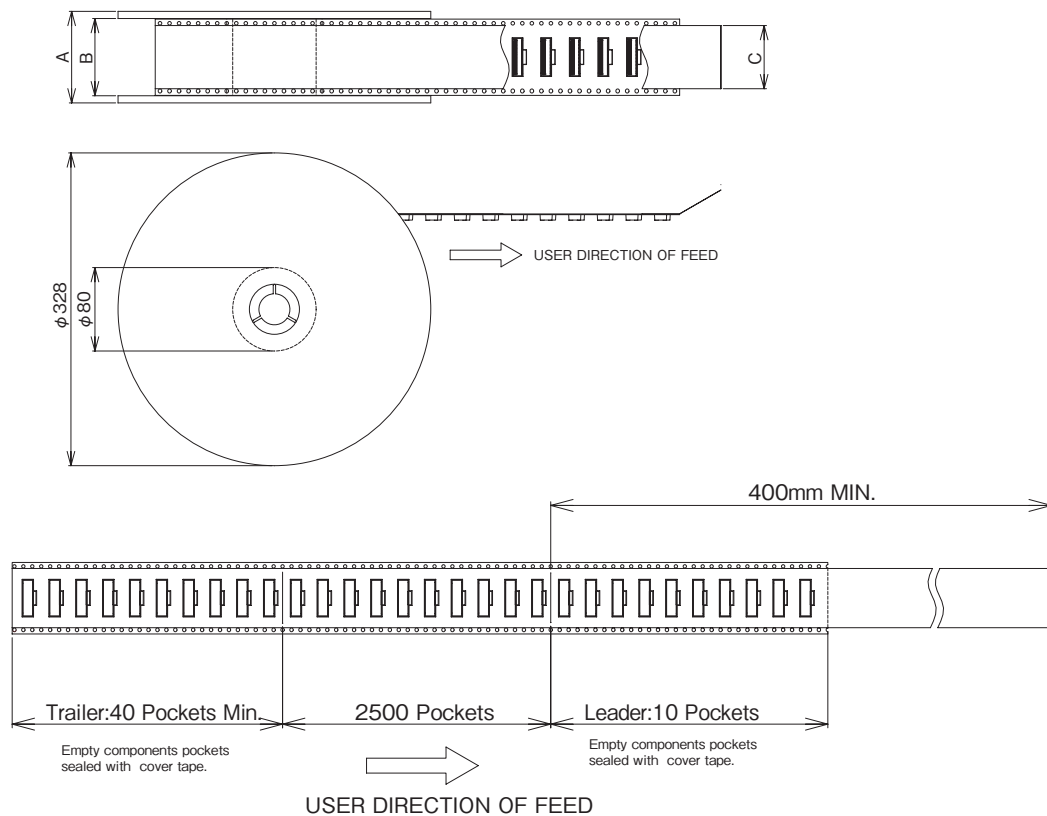

## ■Emboss-Tape Dimensions

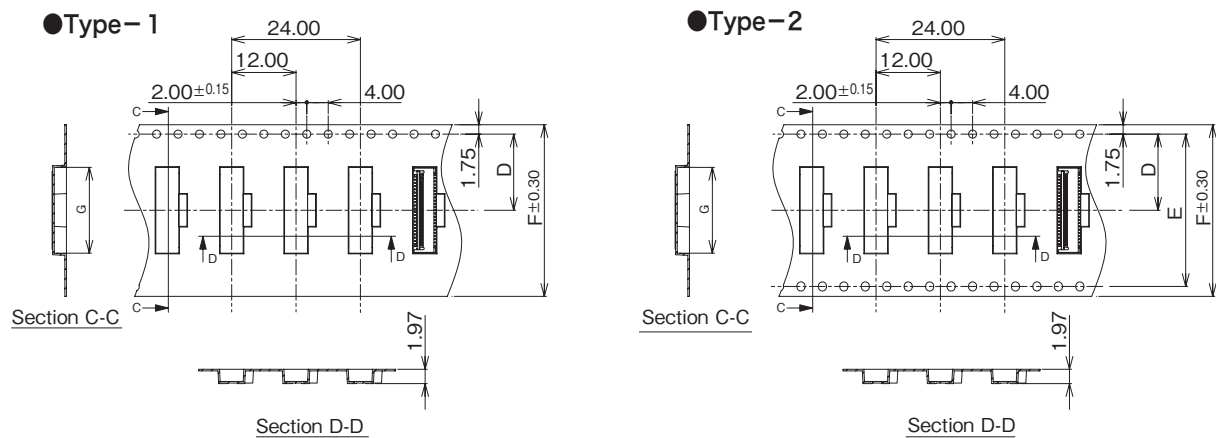

P / N	Number of contact	A	B	C	D	E	F	G	Used Emboss-Type
FF12-17A-R1□A	17	30.4	24.4	21.5	11.5	—	24.0	7.6	Type-1
FF12-18A-R1□A	18							7.9	
FF12-25A-R1□A	25							10.0	
FF12-27A-R1□A	27							10.6	
FF12-29A-R1□A	29							11.2	
FF12-33A-R1□A	33	38.4	32.4	26.5	14.2	28.4	32.0	12.4	Type-2
FF12-39A-R1□A	39							14.2	

■Packing Quantity : 2,500pcs / Reel

Unit:mm

## ■ Reel Dimensions

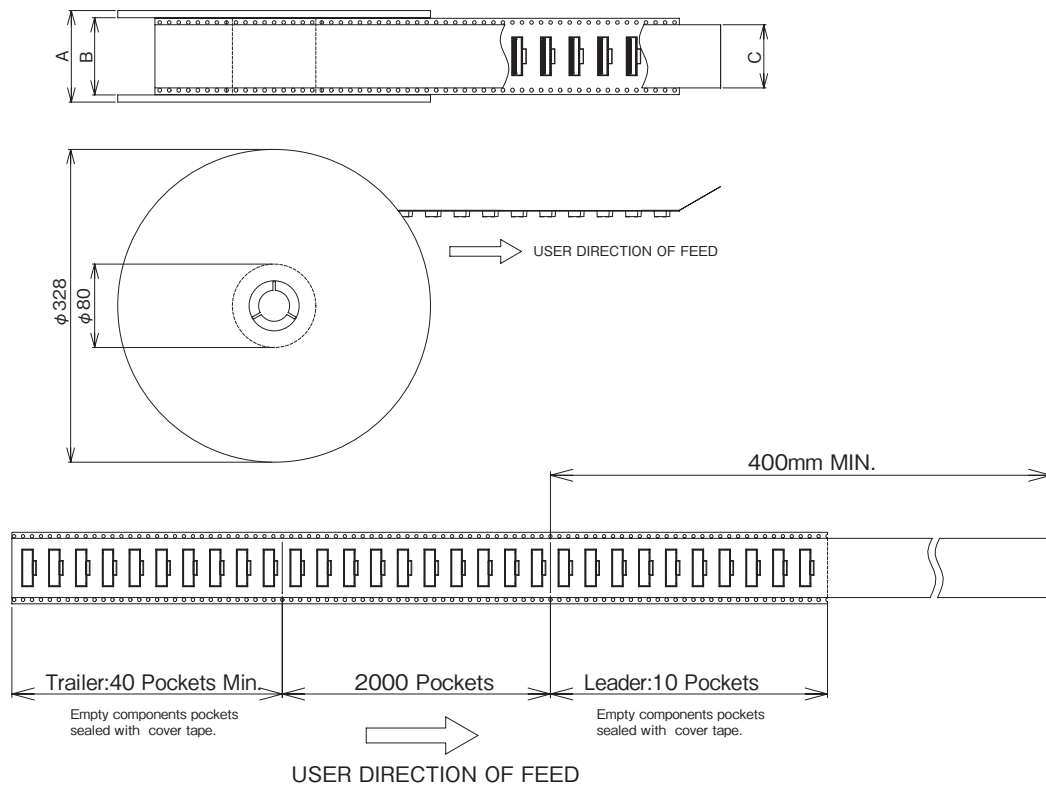

## ■ Emboss-Tape Dimensions

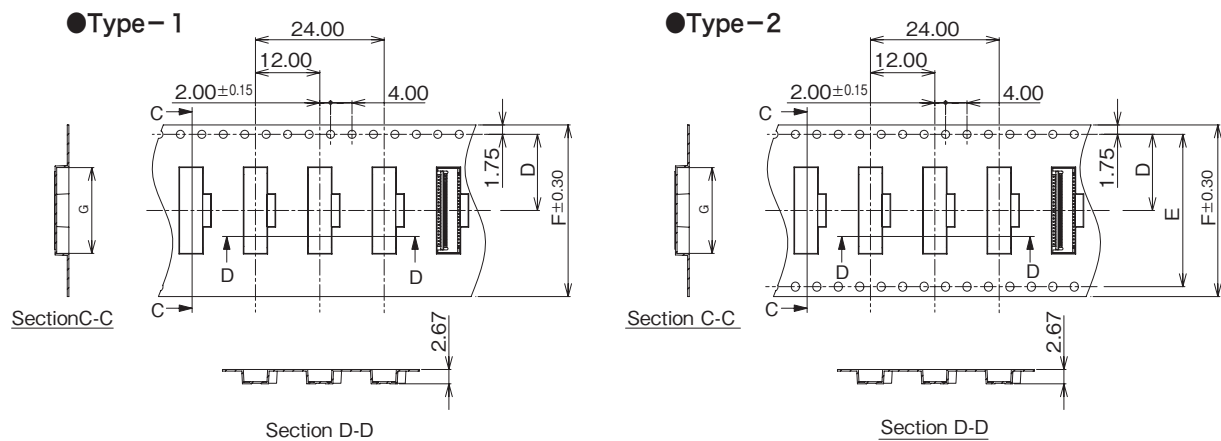

P / N	Number of contact	A	B	C	D	E	F	G	Used Emboss-Type
FF12- 8A-R1□B	8							4.9	タイプ-1
FF12-12A-R1□B	12							6.1	
FF12-17A-R1□B	17							7.6	
FF12-21A-R1□B	21							8.8	
FF12-23A-R1□B	23	30.4	24.4	21.5	11.5	—	24.0	9.4	
FF12-25A-R1□B	25							10.0	
FF12-27A-R1□B	27							10.6	
FF12-29A-R1□B	29							11.2	タイプ-2
FF12-33A-R1□B	33							12.4	
FF12-34A-R1□B	34							12.7	
FF12-35A-R1□B	35							13.0	
FF12-39A-R1□B	39	38.4	32.4	26.5	14.2	28.4	32.0	14.2	
FF12-45A-R1□B	45							16.0	
FF12-51A-R1□B	51							17.8	

■ Packing Quantity : 2,000pcs / Reel

## 1. Connector mounting method

Since free of lock delivered, you need not operate the lock before inserting FPC.

(Refer to picture: ①)

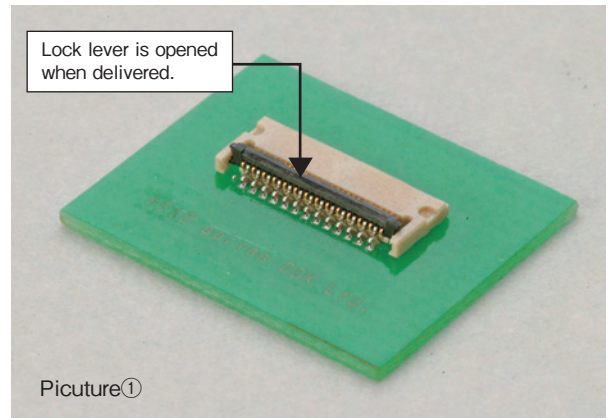

## 2. FPC insert method

When the upper contact is used, insert the conductor to face up.

When the lower contact is used, insert the reinforcement side to face up.

Above point of contact: Refer to picture②

Bottom point of contact: Refer to picture③

Please insert FPC straight in the connector.

Some power is necessary for insertion because of the adoption of FPC temporary maintenance mechanism.

Please confirm whether FPC can be firmly inserted in the interior.

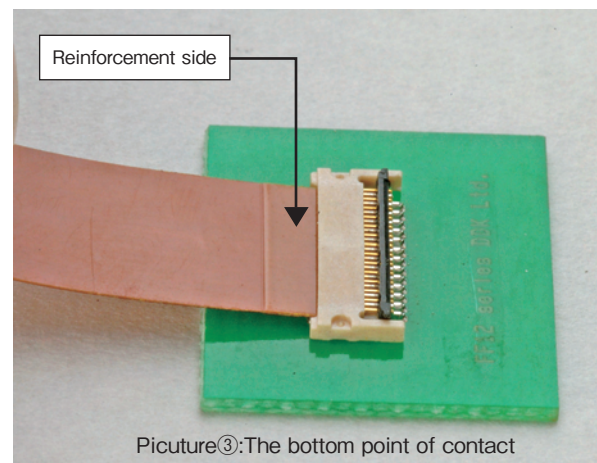
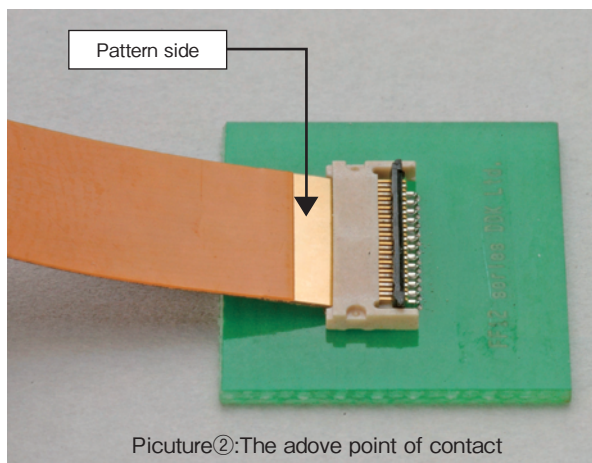

### 3-1. FPC confirm method (For the above point of contact)

Diagonal insertion and shallow insertion can be prevented by the thing to compare straight lines of the wall on the housing with the FPC pattern borderline. (Refer to picture: ④, ⑤, ⑥)

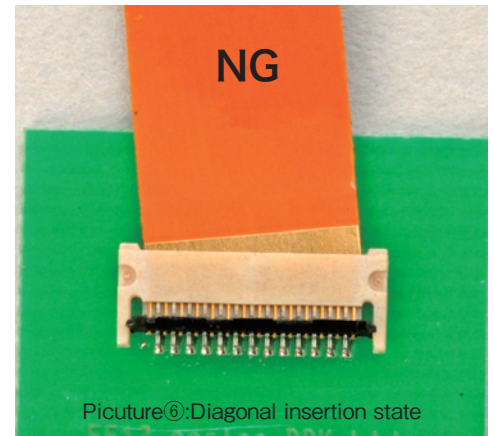
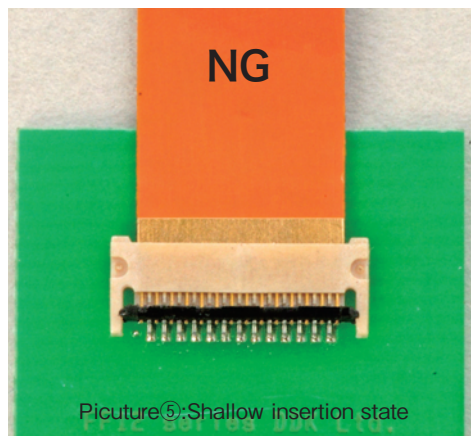
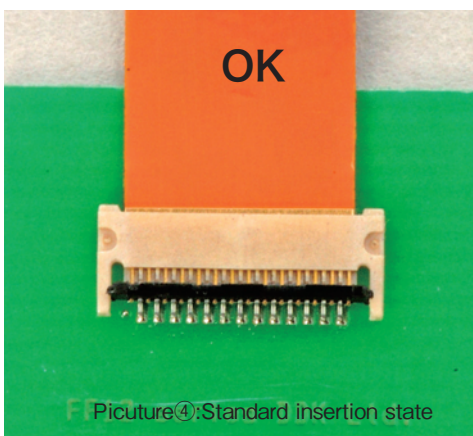

## 3-2. FPC confirm method (For the bottom point of contact)

Diagonal insertion and shallow insertion can be prevented by the thing to compare straight lines of the wall on the housing with the FPC pattern borderline. (Refer to picture: ⑦, ⑧ )

You can confirm the insetion status of FPC if marking the same line as FPC pattern borderline on the reinforcement face. (Refer to: 3-1)

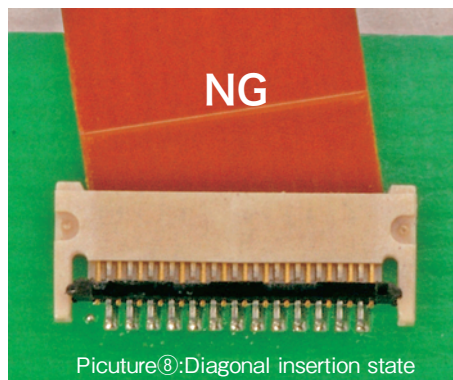
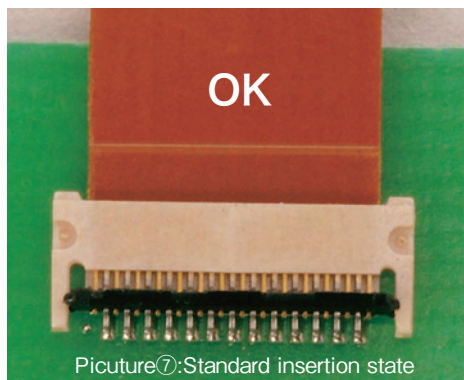

## 4. Lock method

Please depress the lock lever like the rotation. (Picture: ⑨ )

In that case, be careful please not to put extra power on the Housing. (Picture: ⑩ )

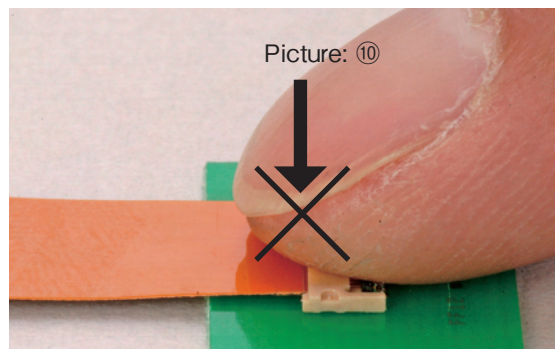
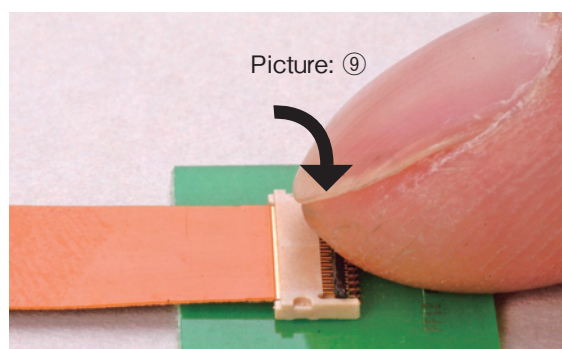

## 5. FPC extraction method

Please leap up the lock lever to the direction of arrow. (Picture: ⑪ , ⑫ )

In that case, be careful please not to put extra power on the Housing. (Picture: ⑬ )

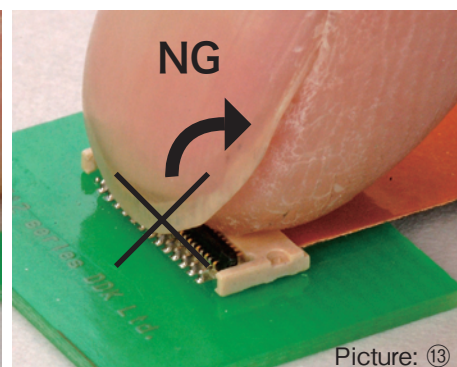
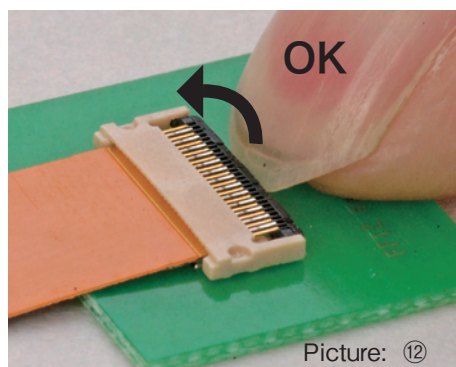
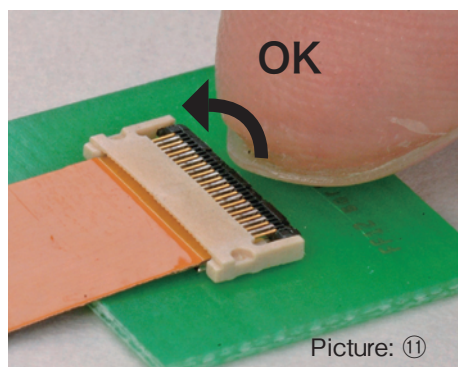



# Recommended Temperature Profiles

RoHS Compliant

## ■ For Sn-Pb plating

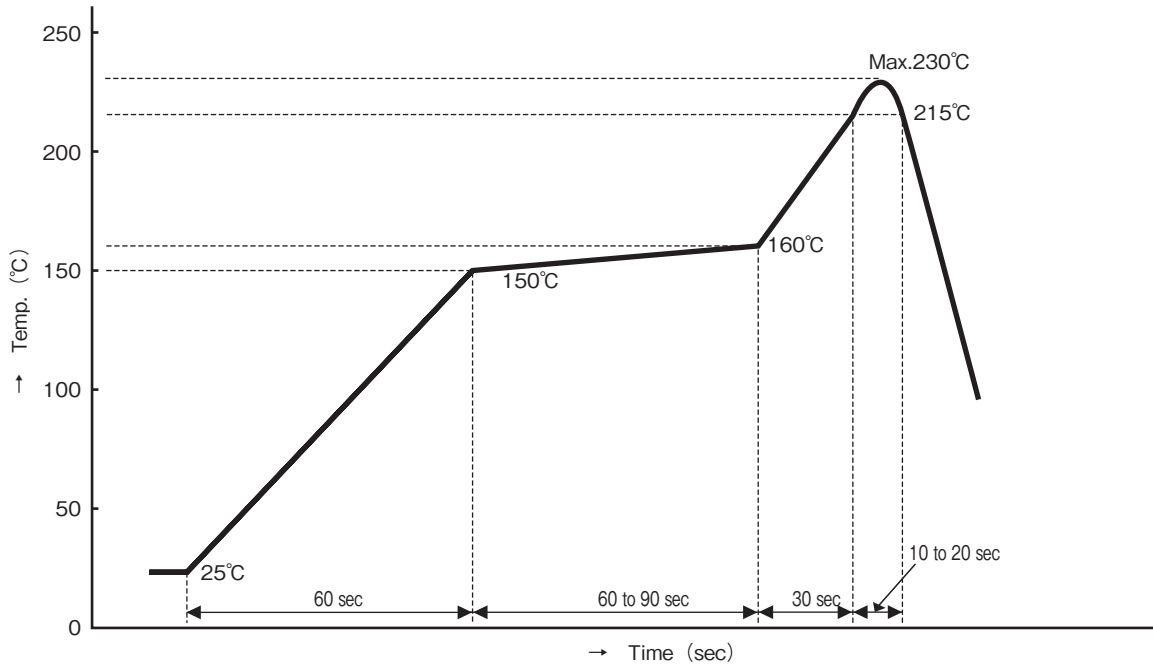

1. Temperature measurement position : Connector terminals.
2. Solder paste : Sn63/Pb37
3. This temperature profile is reference and may change by type and amount of solder, flux, etc. Therefore, this is not to guarantee soldering.

## ■ For lead-free solder plating

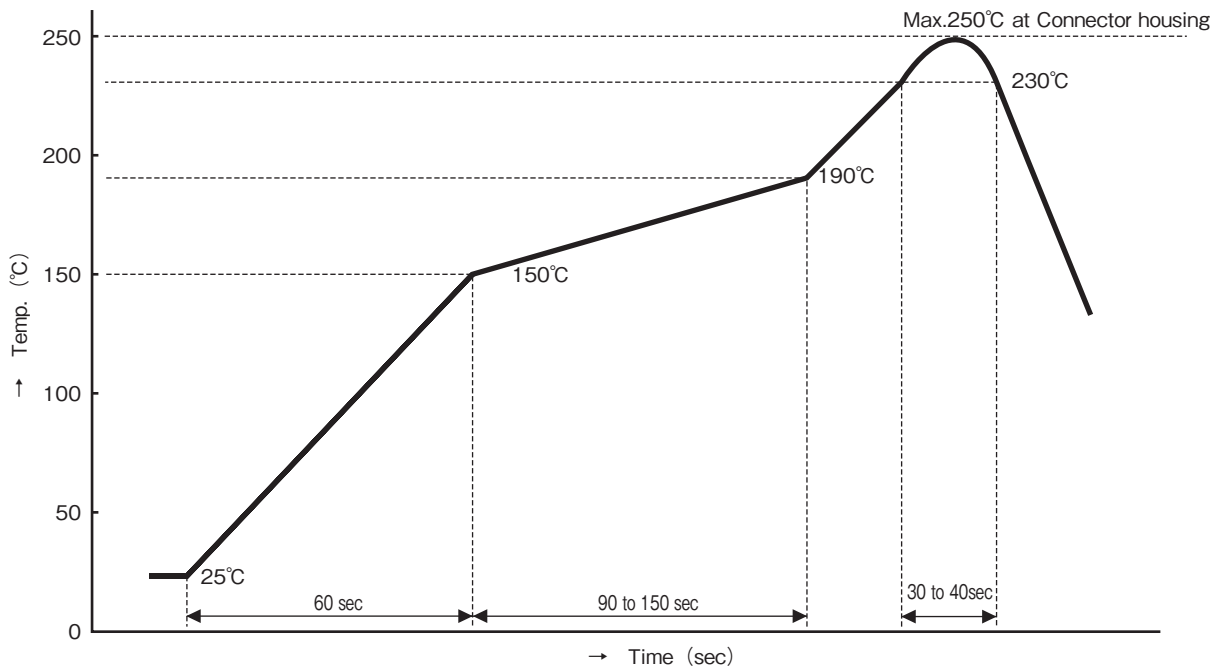

1. Temperature measurement position : Connector terminals.  
However, the temperature on the surface of the housing is 250°C max.
2. Solder paste : Sn96.5/Ag3.0/Cu0.5
3. This temperature profile is reference and may change by type and amount of solder, flux, etc. Therefore, this is not to guarantee soldering.