

IRF3710S

IRF3710L

HEXFET® Power MOSFET

- Advanced Process Technology
- Ultra Low On-Resistance
- Dynamic dv/dt Rating
- 175°C Operating Temperature
- Fast Switching
- Fully Avalanche Rated

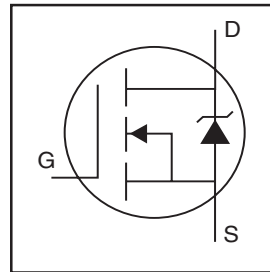

$V_{DSS} = 100V$
$R_{DS(on)} = 23m\Omega$
$I_D = 57A$

Description

Advanced HEXFET® Power MOSFETs from International Rectifier utilize advanced processing techniques to achieve extremely low on-resistance per silicon area. This benefit, combined with the fast switching speed and ruggedized device design that HEXFET power MOSFETs are well known for, provides the designer with an extremely efficient and reliable device for use in a wide variety of applications.

The D²Pak is a surface mount power package capable of accommodating die sizes up to HEX-4. It provides the highest power capability and the lowest possible on-resistance in any existing surface mount package. The D²Pak is suitable for high current applications because of its low internal connection resistance and can dissipate up to 2.0W in a typical surface mount application. The through-hole version (IRF3710L) is available for low-profile applications.

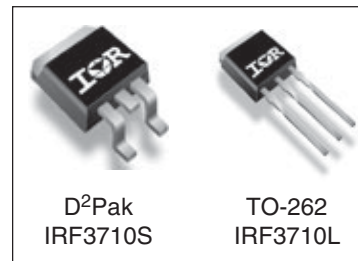

D²Pak
IRF3710S

TO-262
IRF3710L

Absolute Maximum Ratings

	Parameter	Max.	Units
$I_D @ T_C = 25^\circ C$	Continuous Drain Current, $V_{GS} @ 10V$ ⑦	57	A
$I_D @ T_C = 100^\circ C$	Continuous Drain Current, $V_{GS} @ 10V$ ⑦	40	
I_{DM}	Pulsed Drain Current ① ⑦	180	
$P_D @ T_C = 25^\circ C$	Power Dissipation	200	W
	Linear Derating Factor	1.3	W/°C
V_{GS}	Gate-to-Source Voltage	± 20	V
I_{AR}	Avalanche Current ①	28	A
E_{AR}	Repetitive Avalanche Energy ①	20	mJ
dv/dt	Peak Diode Recovery dv/dt ③ ⑦	5.8	V/ns
T_J	Operating Junction and	-55 to + 175	°C
T_{STG}	Storage Temperature Range		
	Soldering Temperature, for 10 seconds		

Thermal Resistance

	Parameter	Typ.	Max.	Units
$R_{\theta JC}$	Junction-to-Case	—	0.75	°C/W
$R_{\theta JA}$	Junction-to-Ambient (PCB Mounted, steady-state)**	—	40	

IRF3710S/IRF3710L

International
IR Rectifier

Electrical Characteristics @ T_J = 25°C (unless otherwise specified)

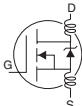
	Parameter	Min.	Typ.	Max.	Units	Conditions
V _{(BR)DSS}	Drain-to-Source Breakdown Voltage	100	—	—	V	V _{GS} = 0V, I _D = 250μA
ΔV _{(BR)DSS} /ΔT _J	Breakdown Voltage Temp. Coefficient	—	0.13	—	V/°C	Reference to 25°C, I _D = 1mA⑦
R _{DS(on)}	Static Drain-to-Source On-Resistance	—	—	23	mΩ	V _{GS} = 10V, I _D = 28A ④
V _{GS(th)}	Gate Threshold Voltage	2.0	—	4.0	V	V _{DS} = V _{GS} , I _D = 250μA
g _{fs}	Forward Transconductance	32	—	—	S	V _{DS} = 25V, I _D = 28A④⑦
I _{DSS}	Drain-to-Source Leakage Current	—	—	25	μA	V _{DS} = 100V, V _{GS} = 0V
		—	—	250		V _{DS} = 80V, V _{GS} = 0V, T _J = 150°C
I _{GSS}	Gate-to-Source Forward Leakage	—	—	100	nA	V _{GS} = 20V
	Gate-to-Source Reverse Leakage	—	—	-100		V _{GS} = -20V
Q _g	Total Gate Charge	—	—	130	nC	I _D = 28A
Q _{gs}	Gate-to-Source Charge	—	—	26		V _{DS} = 80V
Q _{gd}	Gate-to-Drain ("Miller") Charge	—	—	43		V _{GS} = 10V, See Fig. 6 and 13⑦
t _{d(on)}	Turn-On Delay Time	—	12	—	ns	V _{DD} = 50V
t _r	Rise Time	—	58	—		I _D = 28A
t _{d(off)}	Turn-Off Delay Time	—	45	—		R _G = 2.5Ω
t _f	Fall Time	—	47	—		V _{GS} = 10V, See Fig. 10 ④⑦
L _D	Internal Drain Inductance	—	4.5	—	nH	Between lead, 6mm (0.25in.) from package and center of die contact
L _S	Internal Source Inductance	—	7.5	—		
C _{iss}	Input Capacitance	—	3130	—	pF	V _{GS} = 0V
C _{oss}	Output Capacitance	—	410	—		V _{DS} = 25V
C _{rss}	Reverse Transfer Capacitance	—	72	—		f = 1.0MHz, See Fig. 5⑦
E _{AS}	Single Pulse Avalanche Energy②⑦	—	1060③	280⑥		mJ

Source-Drain Ratings and Characteristics

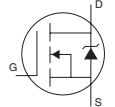
	Parameter	Min.	Typ.	Max.	Units	Conditions
I _S	Continuous Source Current (Body Diode)	—	—	57	A	MOSFET symbol showing the integral reverse p-n junction diode. 
I _{SM}	Pulsed Source Current (Body Diode)①	—	—	230		
V _{SD}	Diode Forward Voltage	—	—	1.2	V	T _J = 25°C, I _S = 28A, V _{GS} = 0V ④
t _{rr}	Reverse Recovery Time	—	140	220	ns	T _J = 25°C, I _F = 28A
Q _{rr}	Reverse Recovery Charge	—	670	1010	nC	di/dt = 100A/μs ④
t _{on}	Forward Turn-On Time	Intrinsic turn-on time is negligible (turn-on is dominated by L _S +L _D)				

Notes:

- ① Repetitive rating; pulse width limited by max. junction temperature. (See fig. 11).
- ② Starting T_J = 25°C, L = 0.70mH, R_G = 25Ω, I_{AS} = 28A, V_{GS} = 10V. (See Figure 12).
- ③ I_{SD} ≤ 28A, di/dt ≤ 380A/μs, V_{DD} ≤ V_{(BR)DSS}, T_J ≤ 175°C.
- ④ Pulse width ≤ 400μs; duty cycle ≤ 2%.

⑤ This is a typical value at device destruction and represents operation outside rated limits.

⑥ This is a calculated value limited to T_J = 175°C.

⑦ Uses IRF3710 data and test conditions.

**When mounted on 1" square PCB (FR-4 or G-10 Material). For recommended footprint and soldering techniques refer to application note #AN-994.

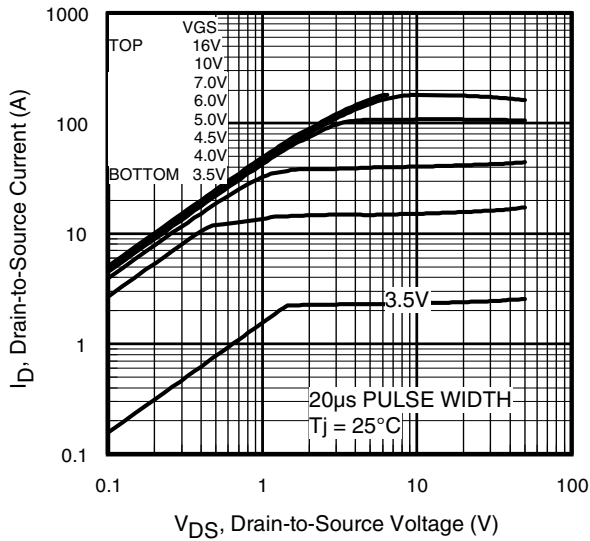

Fig 1. Typical Output Characteristics

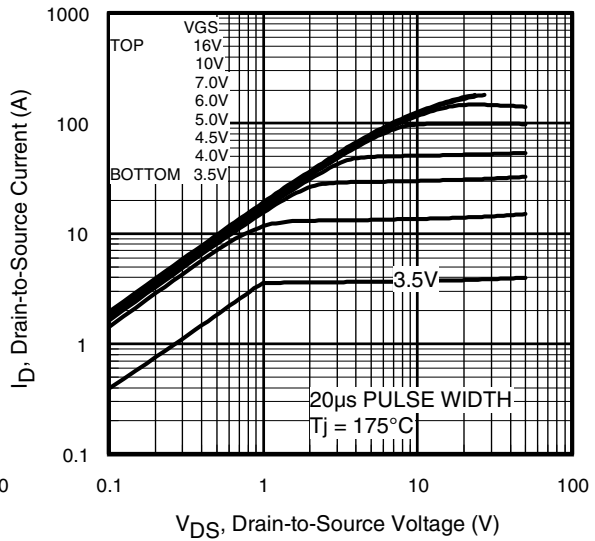

Fig 2. Typical Output Characteristics

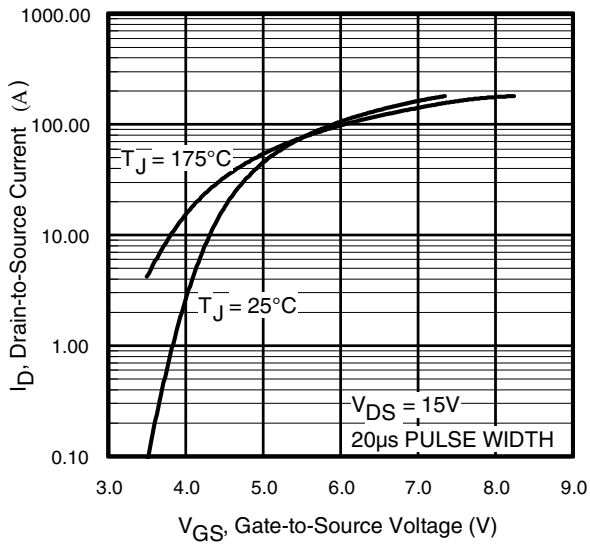

Fig 3. Typical Transfer Characteristics

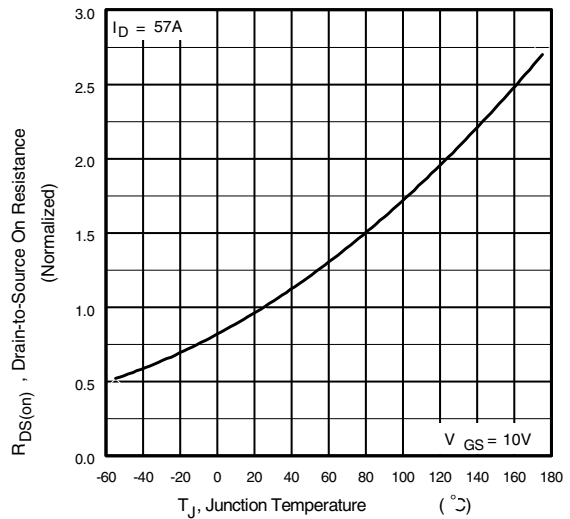

Fig 4. Normalized On-Resistance Vs. Temperature

IRF3710S/IRF3710L

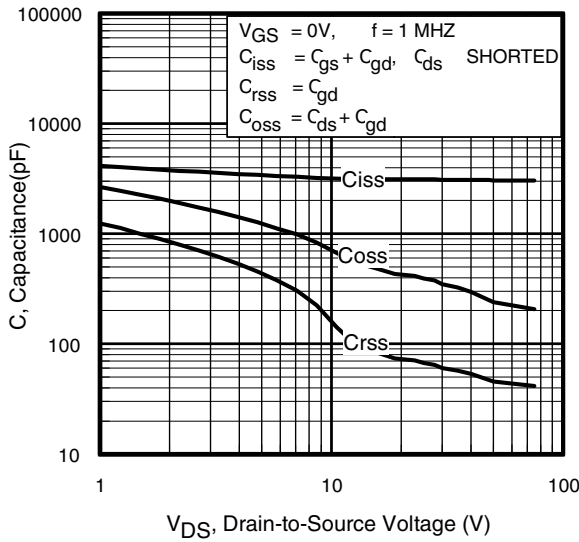

Fig 5. Typical Capacitance Vs. Drain-to-Source Voltage

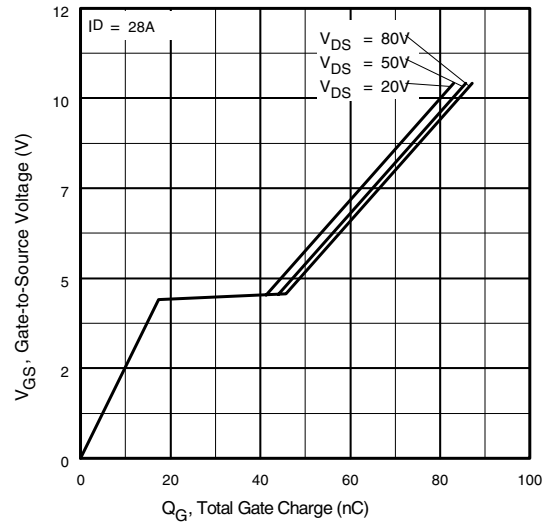

Fig 6. Typical Gate Charge Vs. Gate-to-Source Voltage

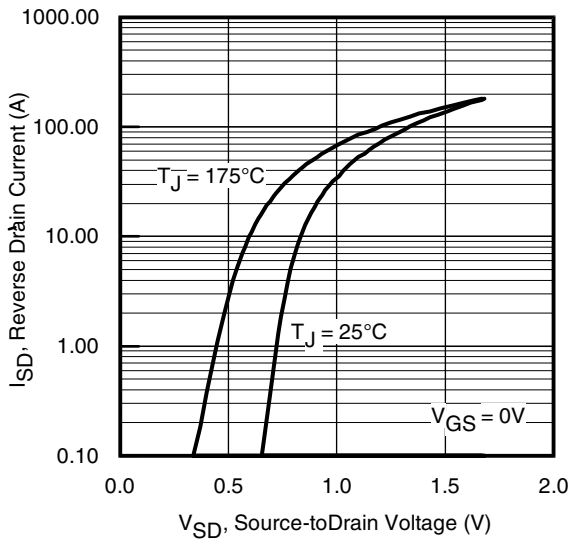

Fig 7. Typical Source-Drain Diode Forward Voltage

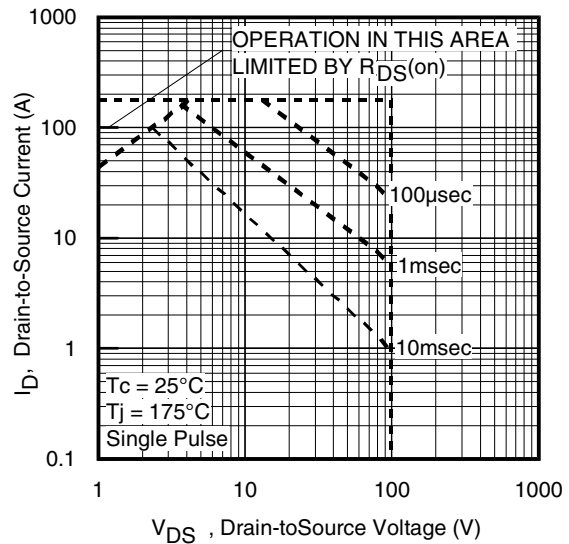

Fig 8. Maximum Safe Operating Area

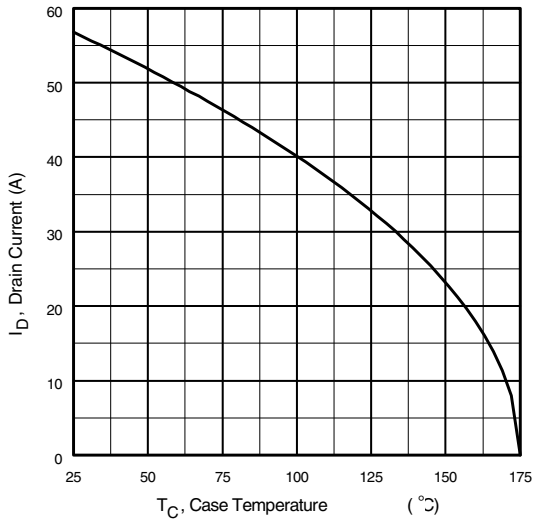

Fig 9. Maximum Drain Current Vs. Case Temperature

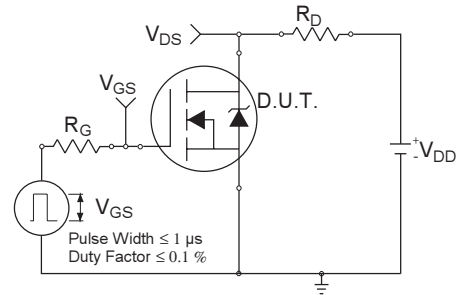

Fig 10a. Switching Time Test Circuit

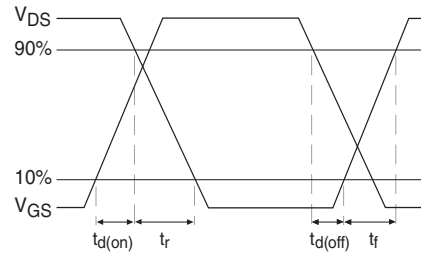

Fig 10b. Switching Time Waveforms

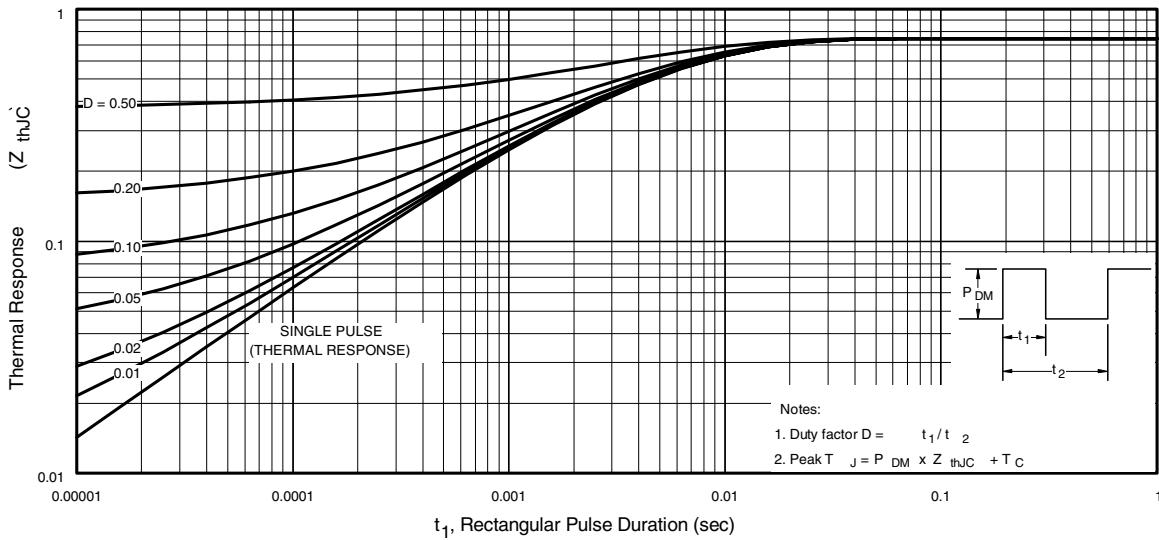

Fig 11. Maximum Effective Transient Thermal Impedance, Junction-to-Case

IRF3710S/IRF3710L

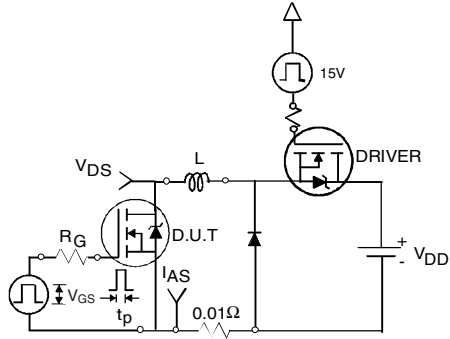

Fig 12a. Unclamped Inductive Test Circuit

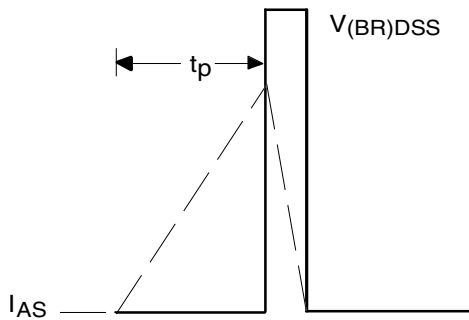

Fig 12b. Unclamped Inductive Waveforms

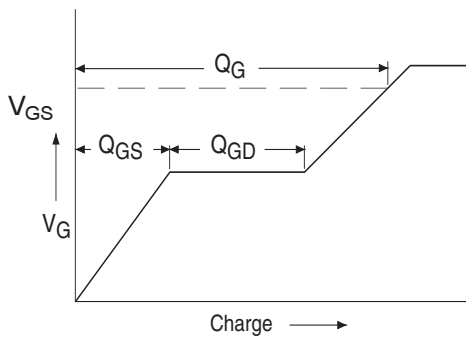

Fig 13a. Basic Gate Charge Waveform

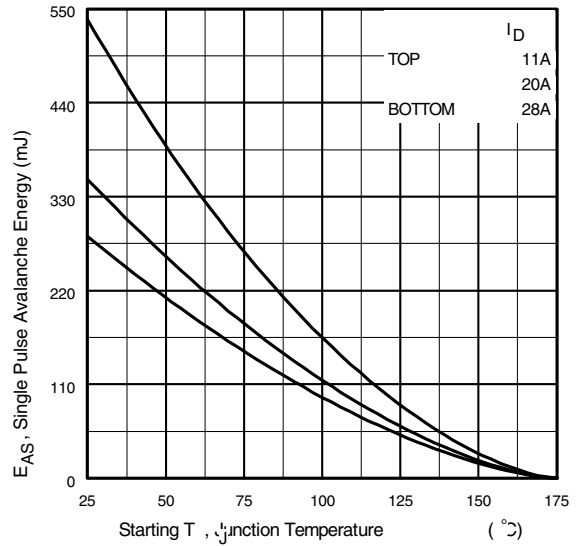

Fig 12c. Maximum Avalanche Energy Vs. Drain Current

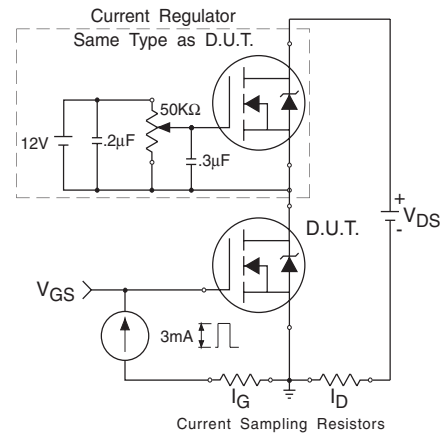
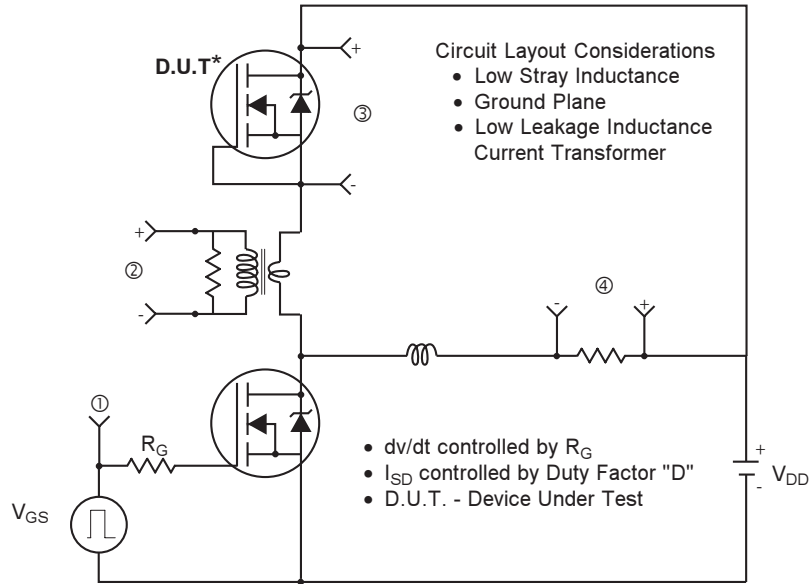
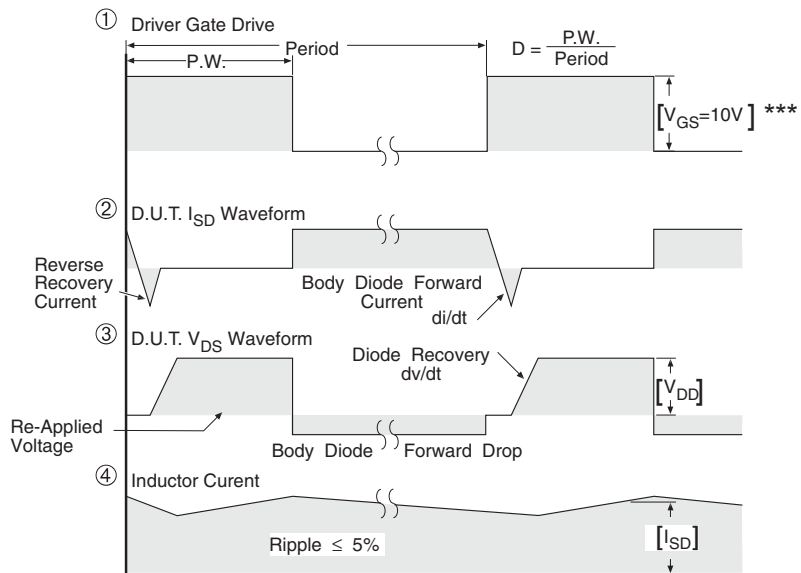

Fig 13b. Gate Charge Test Circuit

Peak Diode Recovery dv/dt Test Circuit



* Reverse Polarity of D.U.T for P-Channel



*** $V_{GS} = 5.0V$ for Logic Level and 3V Drive Devices

Fig 14. For N-channel HEXFET® power MOSFETs

IRF3710S/IRF3710L

International
IR Rectifier

D²Pak Package Outline

Dimensions are shown in millimeters (inches)

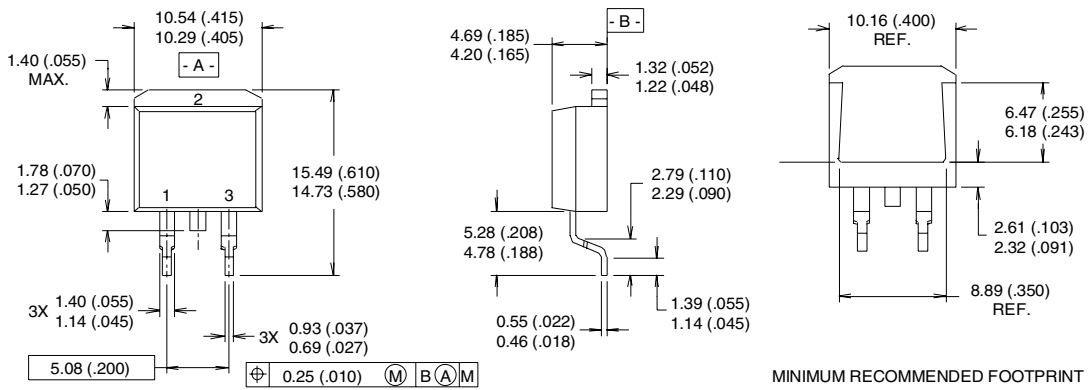

NOTES:

- 1 DIMENSIONS AFTER SOLDER DIP.
- 2 DIMENSIONING & TOLERANCING PER ANSI Y14.5M, 1982.
- 3 CONTROLLING DIMENSION : INCH.
- 4 HEATSINK & LEAD DIMENSIONS DO NOT INCLUDE BURRS.

LEAD ASSIGNMENTS

- 1 - GATE
- 2 - DRAIN
- 3 - SOURCE

MINIMUM RECOMMENDED FOOTPRINT

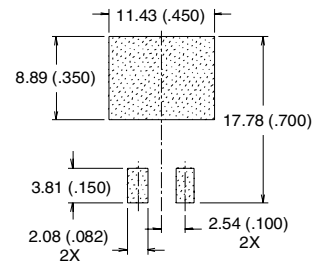

D²Pak Part Marking Information

EXAMPLE: THIS IS AN IRF530S WITH
LOT CODE 8024
ASSEMBLED ON WW 02, 2000
IN THE ASSEMBLY LINE "L"

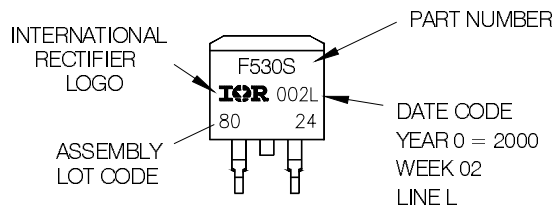

TO-262 Package Outline

Dimensions are shown in millimeters (inches)

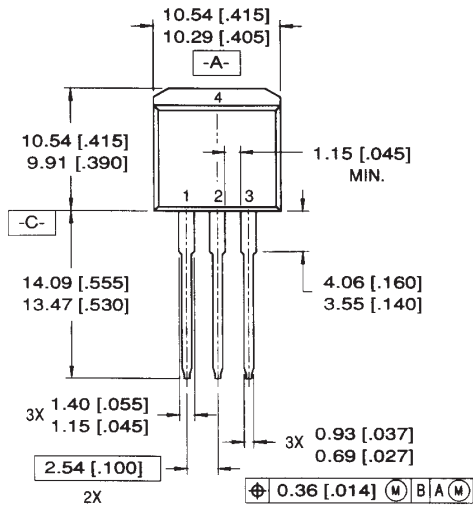

LEAD ASSIGNMENTS

- 1 = GATE 3 = SOURCE
- 2 = DRAIN 4 = DRAIN

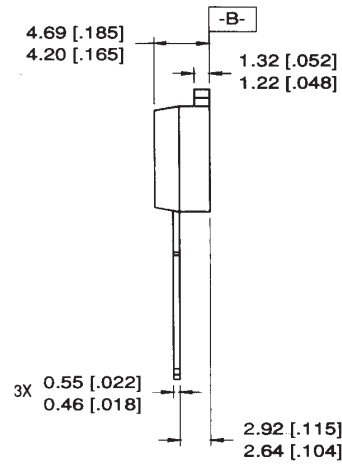

NOTES:

1. DIMENSIONING & TOLERANCING PER ANSI Y14.5M-1982
2. CONTROLLING DIMENSION: INCH.
3. DIMENSIONS ARE SHOWN IN MILLIMETERS [INCHES].
4. HEATSINK & LEAD DIMENSIONS DO NOT INCLUDE BURRS.

TO-262 Part Marking Information

EXAMPLE: THIS IS AN IRL3103L
 LOT CODE 1789
 ASSEMBLED ON WW 19, 1997
 IN THE ASSEMBLY LINE "C"

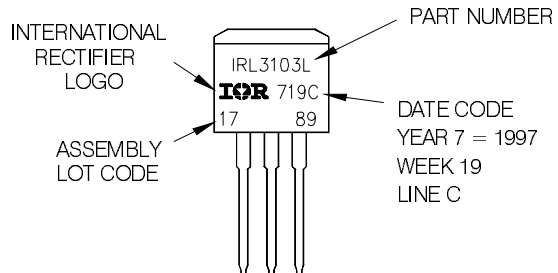

IRF3710S/IRF3710L

International
IR Rectifier

D²Pak Tape & Reel Information

Dimensions are shown in millimeters (inches)

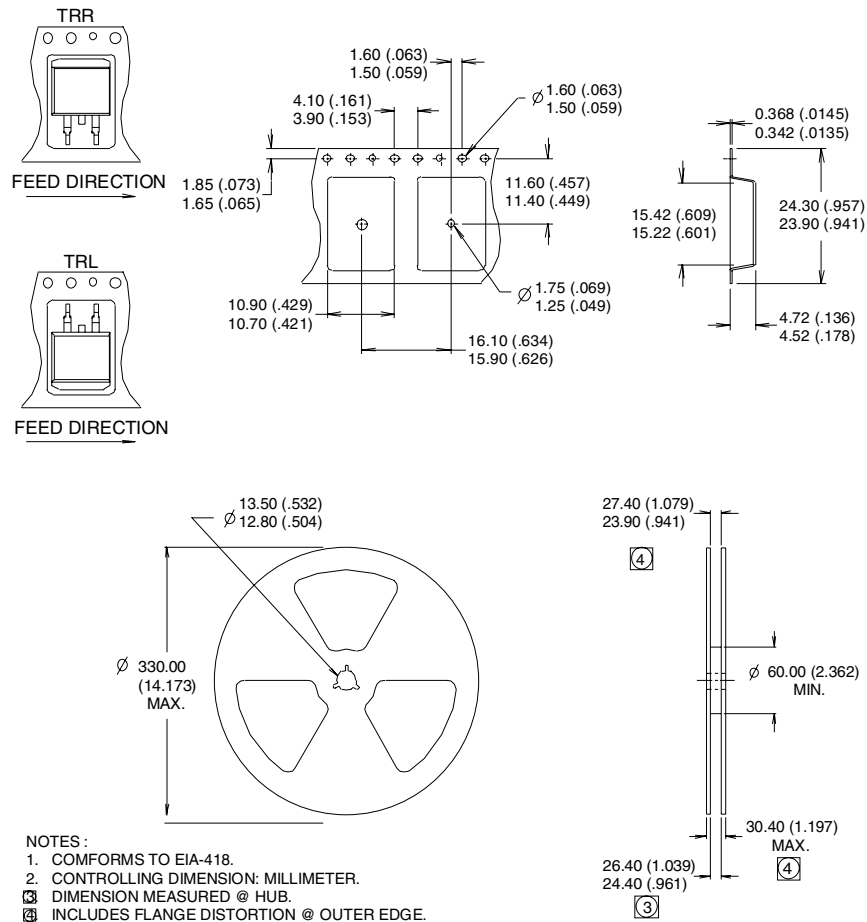

Data and specifications subject to change without notice.
This product has been designed and qualified for the Industrial market.
Qualification Standards can be found on IR's Web site.

International
IR Rectifier

IR WORLD HEADQUARTERS: 233 Kansas St., El Segundo, California 90245, USA Tel: (310) 252-7105
TAC Fax: (310) 252-7903

Visit us at www.irf.com for sales contact information.12/02

www.irf.com