

Intellimod™-3 Modules Single Phase IGBT Inverter Output 200 Amperes/110-230 Volt Line

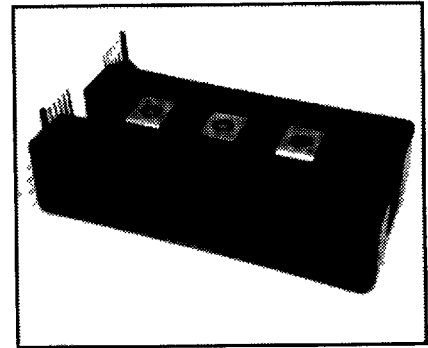
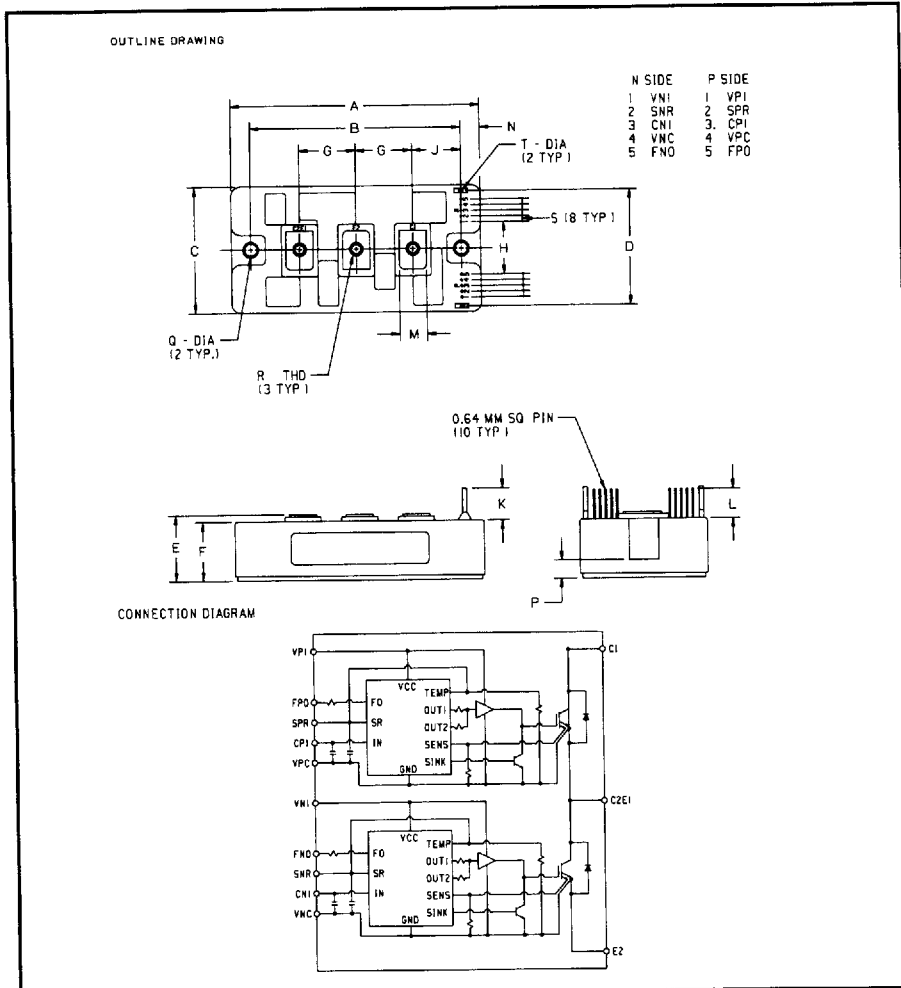

Description

Powerex Intellimod-3 Modules are designed for applications requiring a high frequency (20kHz) output switching inverter. The modules are isolated from the baseplate, consisting of complete drive, control and protection circuitry for the IGBT inverter.

Features:

- Complete Output Power Circuit
- Gate Drive Circuit
- Protection Logic
 - Short Circuit
 - Over-Current
 - Over Temperature
 - Under Voltage

Applications:

- Inverters
- Small UPS
- Motion/Servo Control
- AC Motor Control

Ordering Information

PM200DHA060

110-230 Volt Line, PM200DHA060 Outline Drawing

Dimensions	Inches	Millimeters
A	4.33	110.0
B	3.66±0.01	93.0±0.25
C	2.2	56.0
D	2.01	51.0
E	1.14+0.04/-0.02	29.0+1.0/-0.5
F	1.02	26.0
G	0.98	25.0
H	0.9	23.0
J	0.85	21.5

Dimensions	Inches	Millimeters
K	0.55	14.0
L	0.51	13.0
M	0.47	12.0
N	0.33	8.5
P	0.31	8.0
Q	0.22 Dia.	5.5 Dia.
R	Metric M5	M5
S	0.1	2.54
T	0.08 Dia.	2.0 Dia.



POWEREX INC

51E D ■ 729462J 0005723 722 ■ PRX

Powerex, Inc., Hillis Street, Youngwood, Pennsylvania 15697 (412) 925-7272

Powerex, Europe, S.A. 428 Avenue G. Durand, BP107, 72003 Le Mans, France (43) 41.14.14

PM200DHA060

Intellimod-3 Modules

Single Phase IGBT Inverter Output

200 Amperes/110-230 Volt Line

T-57-29

Absolute Maximum Ratings, $T_j = 25^\circ\text{C}$ unless otherwise specified

Characteristics	Symbol	PM200DHA060	Units
Power Device Junction Temperature	T_j	-20 to +150	$^\circ\text{C}$
Storage Temperature	T_{STG}	-40 to +125	$^\circ\text{C}$
Case Operating Temperature	T_c	-20 to +100	$^\circ\text{C}$
Mounting Torque, M5 Mounting Screws	—	17	Kg-cm
Mounting Torque, M5 Main Terminal Screws	—	17	Kg-cm
Module Weight (Typical)	—	430	Grams
Supply Voltage Protected by OC and SC ($V_D = 13.5 - 16.5\text{V}$, Inverter Part)	$V_{\text{CC(prot.)}}$	400	Volts
Isolation Voltage AC 1 minute, 60Hz	V_{RMS}	2500	Volts

Control Sector

Supply Voltage Applied between ($V_{P1} - V_{PC}, V_{N1} - V_{NC}$)	V_D	20	Volts
Input Voltage Applied between ($C_{P1} - V_{PC}, C_{N1} - V_{NC}$)	V_{CIN}	10	Volts
Fault Output Supply Voltage Applied between ($F_{PO} - V_{PC}, F_{NO} - V_{NC}$)	V_{FO}	20	Volts
Fault Output Current (Sink Current at F_{PO}, F_{NO} Terminals)	I_{FO}	20	mA

IGBT Inverter Sector

Collector-Emitter Voltage	V_{CES}	600	Volts
Collector Current \pm	I_c	200	Amperes
Peak Collector Current \pm	I_{CP}	400	Amperes
Supply Voltage (Applied C1 to E2)	V_{CC}	450	Volts
Supply Voltage (Surge) Applied C1 to E2	$V_{\text{CC(surge)}}$	500	Volts
Collector Dissipation	P_c	700	Watts

Powerex, Inc., Hillis Street, Youngwood, Pennsylvania 15697 (412) 925-7272
 Powerex, Europe, S.A. 428 Avenue G. Durand, BP107, 72003 Le Mans, France (43) 41.14.14

T-57-29

PM200DHA060
Intellimod-3 Modules
Single Phase IGBT Inverter Output
 200 Amperes/110-230 Volt Line

Electrical Characteristics, $T_j = 25^\circ\text{C}$ unless otherwise specified

Characteristics	Symbol	Test Conditions	Min.	Typ.	Max.	Units
Control Sector						
Overcurrent Trip Level	OC	$-20^\circ\text{C} \leq T \leq 125^\circ\text{C}$, Fig. 5	310	400	–	Amperes
Short Circuit Trip Level	SC	$-20^\circ\text{C} \leq T \leq 125^\circ\text{C}$, Fig. 5	400	560	–	Amperes
Over Current Delay Time	$t_{off(OC)}$	$V_D = 15\text{V}$, Fig. 5	–	5	–	μS
Over Temperature Protection	OT	Trip Level	100	110	120	$^\circ\text{C}$
Over Temperature Protection	OT _R	Reset Level	85	95	105	$^\circ\text{C}$
Supply Circuit Under Voltage Protection	UV	Trip Level	11.5	12.0	12.5	Volts
Supply Circuit Under Voltage Protection	UV _R	Reset Level	–	12.5	–	Volts
Supply Voltage	V_D	Applied between $V_{P1} - V_{PC}, V_{N1} - V_{NC}$	13.5	15	16.5	Volts
Circuit Current	I_D	$V_D = 15\text{V}, V_{CIN} = 5\text{V}, V_{N1} - V_{NC}$	–	13	20	mA
	I_D	$V_D = 15\text{V}, V_{CIN} = 5\text{V}, V_{P1} - V_{PC}$	–	13	20	mA
Input On Voltage	$V_{CIN(on)}$	Applied between	1.2	1.5	1.8	Volts
Input Off Voltage	$V_{CIN(off)}$	$C_{P1} - V_{PC}, C_{N1} - V_{NC}$	1.7	2.0	2.3	Volts
PWM Input Frequency	f_{PWM}	3- \emptyset Sinusoidal	–	15	20	kHz
Dead Time	t_{DEAD}	For each Input Pulse	4.0	–	–	μS
		Using example Interface Circuit*	6.0	–	–	μS
Fault Output Current	$I_{FO(H)}$	$V_D = 15\text{V}, V_{FO} = 15\text{V}$	–	–	0.01	mA
	$I_{FO(L)}$	$V_D = 15\text{V}, V_{FO} = 15\text{V}$	–	10	15	mA
Minimum Fault Output Pulse Width	t_{FO}	$V_D = 15\text{V}$	1.0	1.8	–	mS
SXR Terminal Output Voltage	V_{SXR}	$T_j = 125^\circ\text{C}, R_{IN} = 6.8\text{k}\Omega, (S_{PR}, S_{NR})$	4.5	5.1	5.6	Volts

*See Intellimod-3 Applications Data Section 4.3.

Powerex, Inc., Hillis Street, Youngwood, Pennsylvania 15697 (412) 925-7272
 Powerex, Europe, S.A. 428 Avenue G. Durand, BP107, 72003 Le Mans, France (43) 41.14.14

T-57-29

PM200DHA060
 Intellimod-3 Modules
 Single Phase IGBT Inverter Output
 200 Amperes/110-230 Volt Line

Electrical Characteristics, $T_j = 25^\circ\text{C}$ unless otherwise specified

Characteristics	Symbol	Test Conditions	Min.	Typ.	Max.	Units
IGBT Inverter Sector						
Collector Cutoff Current	I_{CEX}	$V_{CE} = V_{CES}, T_j = 25^\circ\text{C}$, Fig. 4	-	-	1	mA
Collector Cutoff Current	I_{CEX}	$V_{CE} = V_{CES}, T_j = 125^\circ\text{C}$, Fig. 4	-	-	10.0	mA
Diode Forward Voltage	V_{FM}	$-I_C = 200\text{A}, V_{CIN} = 5\text{V}$, Fig. 2	-	1.6	2.5	Volts
Collector Emitter Saturation Voltage	$V_{CE(sat)}$	$V_D = 15\text{V}, V_{CIN} = 0\text{V}, I_C = 200\text{A}$, Fig. 1	-	2.6	3.5	Volts
Collector Emitter Saturation Voltage	$V_{CE(sat)}$	$V_D = 15\text{V}, V_{CIN} = 0\text{V}, I_C = 200\text{A}$, $T_j = 125^\circ\text{C}$, Fig. 1	-	2.4	3.4	Volts
Inductive Load Switching Times	t_{on}	$V_D = 15\text{V}, V_{CIN} = 0\text{V}$,	0.5	1.4	2.5	μS
	t_{rr}	$V_{CC} = 300\text{V}, I_C = 200\text{A}$,	-	0.2	0.4	μS
	$t_{C(on)}$	$T_j = 125^\circ\text{C}$	-	0.5	1.0	μS
	t_{off}	Fig. 3	-	2.0	3.0	μS
	$t_{C(off)}$		-	0.5	1.0	μS

Thermal Characteristics

Characteristics	Symbol	Test Conditions	Min.	Typ.	Max.	Units
Thermal Resistances Junction to Case	$R_{th(j-c)Q}$	Inverter IGBT	-	-	0.16	$^\circ\text{C/W}$
	$R_{th(j-c)F}$	Inverter FWD	-	-	0.35	$^\circ\text{C/W}$
Contact Thermal Resistance	$R_{th(c-f)}$	Case to Fin, Thermal Grease Applied	-	-	0.095	$^\circ\text{C/W}$

Recommended Operating Conditions

Characteristics	Symbol	Test Conditions	Value	Units
Supply Voltage	V_{CC}	Applied across C1 - E2 Terminals	0 ~ 400	Volts
	V_D	Applied between $V_{P1} - V_{PC}, V_{N1} - V_{NC}$	15±1.5	Volts
Input On Voltage	$V_{CIN(on)}$	Applied between	0 ~ 0.8	Volts
Input Off Voltage	$V_{CIN(off)}$	$C_{P1} - V_{PC}, C_{N1} - V_{NC}$	4 ~ V_{SXR}	Volts
PWM Input Frequency	f_{PWM}	Using example Interface Circuit *	5 ~ 20	kHz
Minimum Dead Time	t_{DEAD}	Using example Interface Circuit *	6.0	μS

*See Intellimod-3 Applications Data Section 4.3.

PM200DHA060

Intellimod-3 Modules

Single Phase IGBT Inverter Output

200 Amperes/110-230 Volt Line

SATURATION VOLTAGE CHARACTERISTICS (TYPICAL)

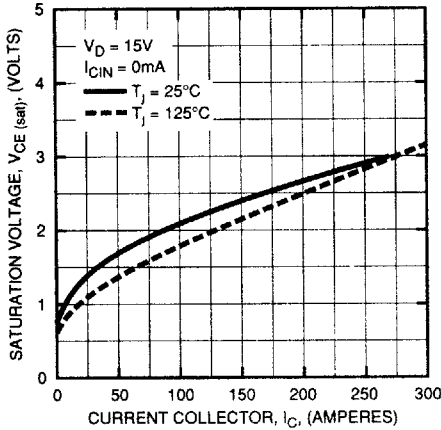

COLLECTOR-EMITTER SATURATION VOLTAGE (TYPICAL)

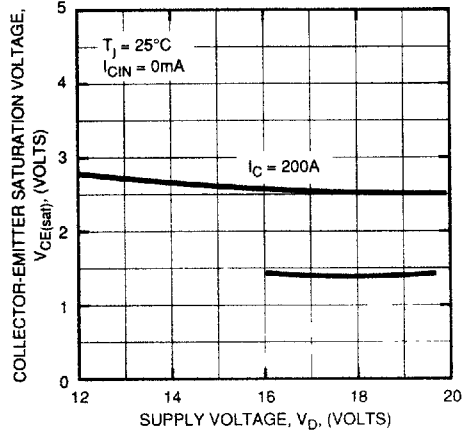

OUTPUT CHARACTERISTICS (TYPICAL)

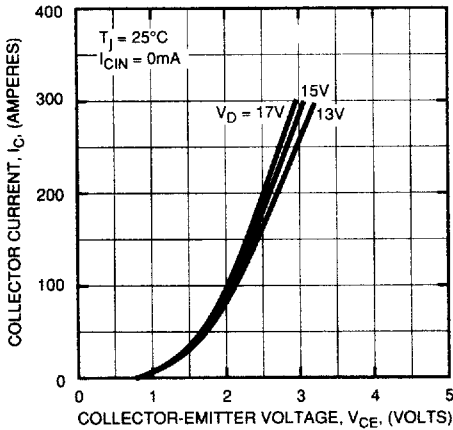

SWITCHING TIME VS. COLLECTOR CURRENT (TYPICAL)

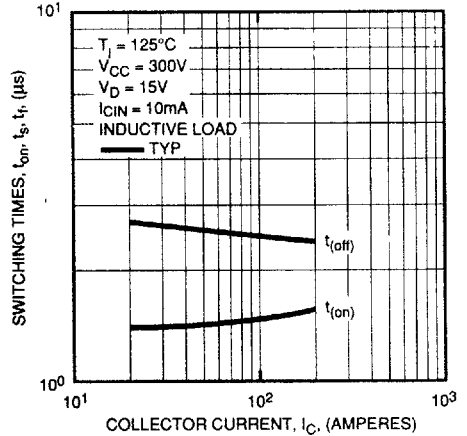

SWITCHING TIME VS. COLLECTOR CURRENT (TYPICAL)

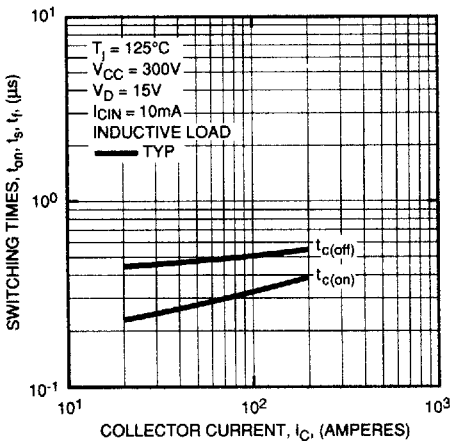

REVERSE COLLECTOR CURRENT VS. EMITTER-COLLECTOR VOLTAGE (DIODE FORWARD CHARACTERISTICS) (TYPICAL)

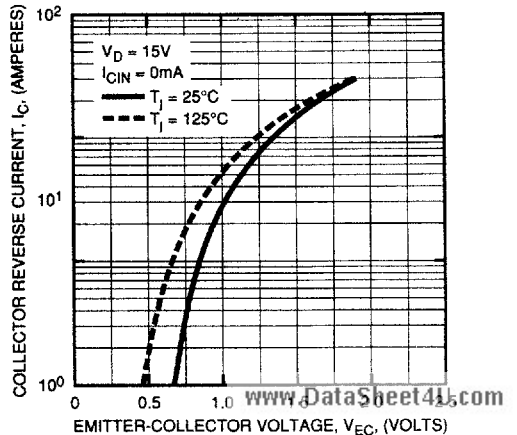



POWEREX INC

51E D ■ 7294621 0005727 378 ■ PRX

Powerex, Inc., Hillis Street, Youngwood, Pennsylvania 15697 (412) 925-7272
 Powerex, Europe, S.A. 428 Avenue G. Durand, BP107, 72003 Le Mans, France (43) 41.14.14

T-57-2

M200DHA060

Intellimod-3 Modules

Single Phase IGBT Inverter Output

200 Amperes/110-230 Volt Line

POWER DISSIPATION DERATING CURVE
(PER IGBT ELEMENT)

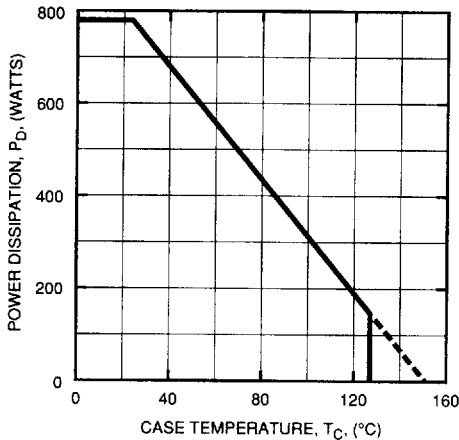

CIRCUIT CURRENT
VS. CARRIER FREQUENCY

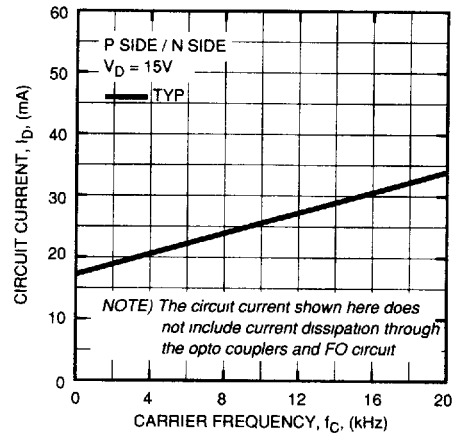

TRANSIENT THERMAL
IMPEDANCE CHARACTERISTICS
(IGBT)

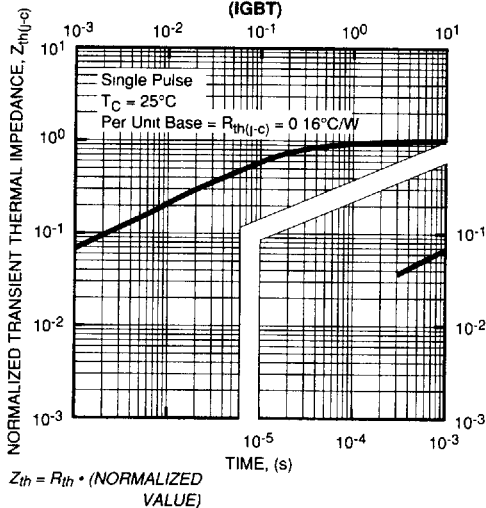

TRANSIENT THERMAL
IMPEDANCE CHARACTERISTICS
(FWD)

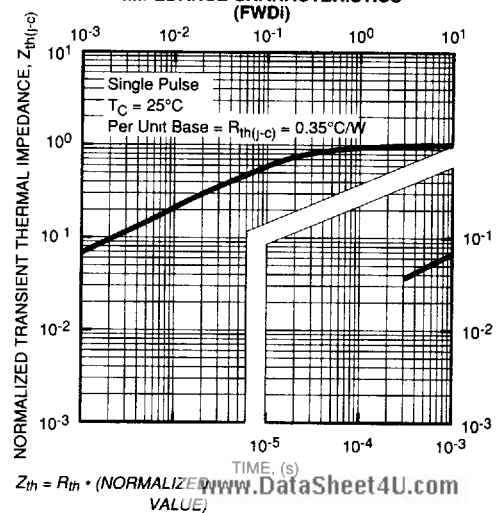

PM200DHA060

Intellimod-3 Modules

Single Phase IGBT Inverter Output

200 Amperes/110-230 Volt Line

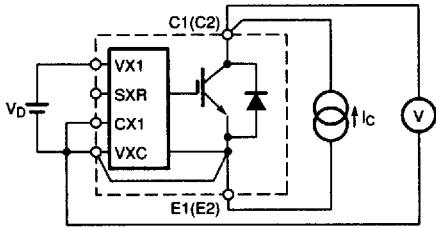

Figure 1 $V_{CE(SAT)}$ Test

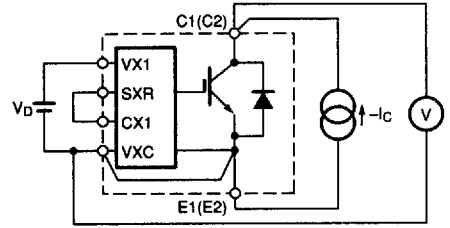

Figure 2 V_{EC} Test

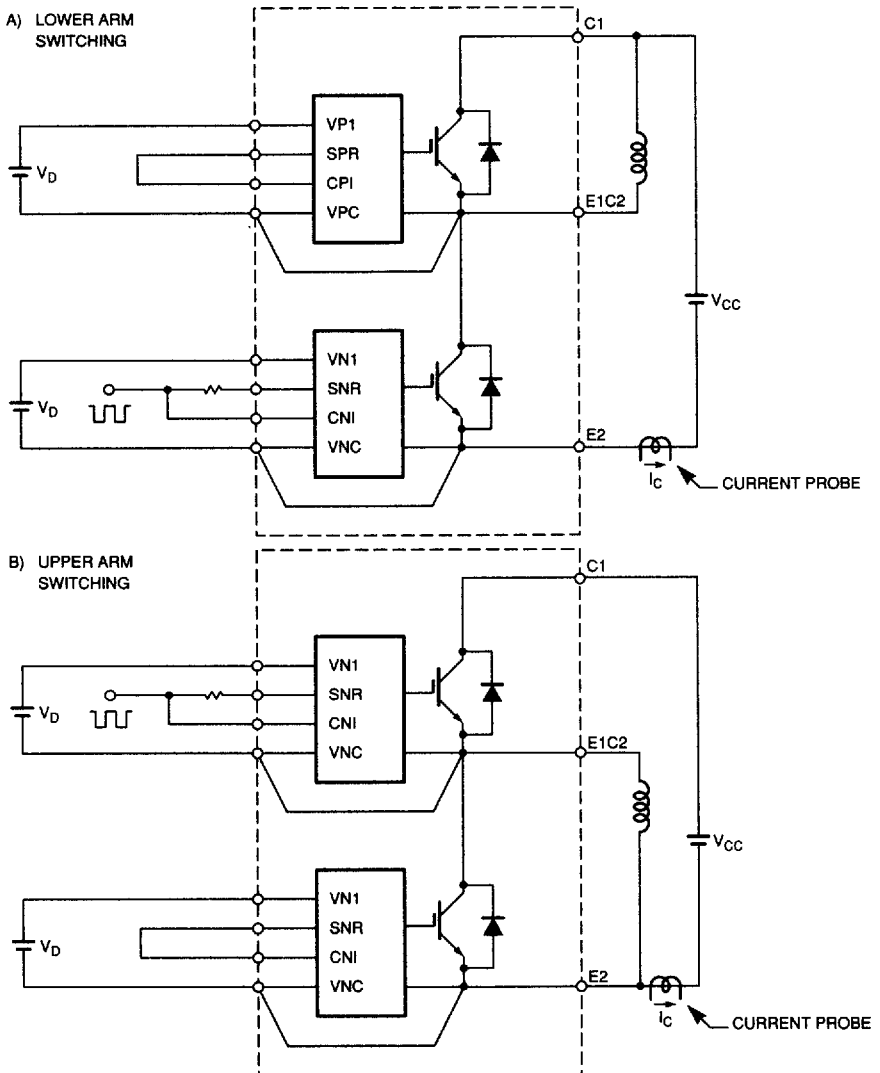

Figure 3 Half Bridge Switching Test and Waveform

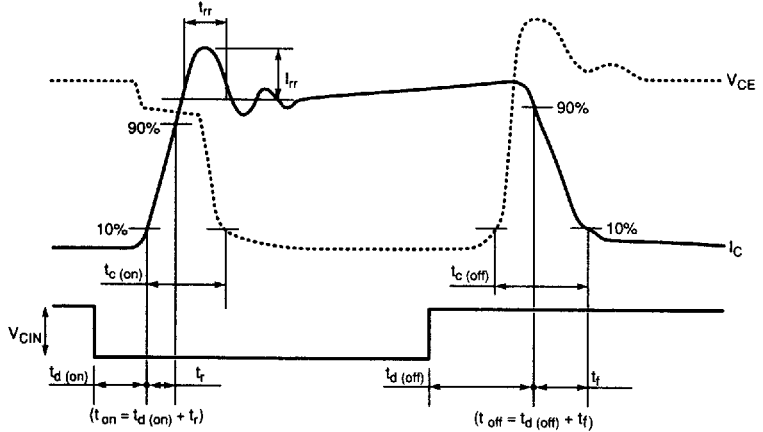

Figure 3 Half Bridge Switching Test and Waveform (Continued)

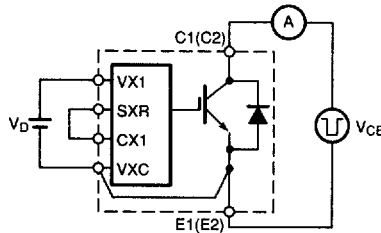

Figure 4 I_{CES} Test

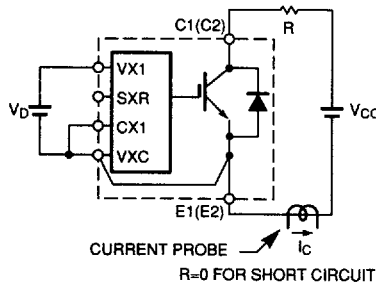

Figure 5 Over Current and Short Circuit Test