

10.0-21.0 GHz GaAs MMIC Buffer Amplifier, QFN

Mimix
BROADBAND™

X B1008-QT
X RoHS

September 2007 - Rev 12-Sep-07

Features

- X Excellent Transmit LO/Output Buffer Stage
- X 3x3mm, QFN
- X 17.0 dB Small Signal Gain
- X +20.0 dBm Psat
- X +32 dBm Output IP3
- X 4.5 dB Noise Figure
- X Variable Gain with Adjustable Bias
- X 100% RF, DC and Output Power Testing



General Description

Mimix Broadband's two stage 10.0-21.0 GHz GaAs MMIC buffer amplifier has a small signal gain of 17.0 dB with a +19.0 dBm P1dB output compression point. The device also provides variable gain regulation with adjustable bias. The device is ideally suited as an LO or RF buffer stage with broadband performance at a very low cost. The device comes in an RoHS compliant 3x3mm QFN surface mount package offering excellent RF and thermal properties. This device is well suited for Microwave and Millimeter-wave Point-to-Point Radio, LMDS, SATCOM and VSAT applications.

Absolute Maximum Ratings

Supply Voltage (Vd)	+6.0 VDC
Supply Current (Id1)	180 mA
Gate Bias Voltage (Vg)	+0.3 VDC
Input Power (Pin)	+20.0 dBm
Storage Temperature (Tstg)	-65 to +165 °C
Operating Temperature (Ta)	-55 to MTTF Graph ¹
Channel Temperature (Tch)	MTTF Graph ¹

(1) Channel temperature affects a device's MTTF. It is recommended to keep channel temperature as low as possible for maximum life.

Electrical Characteristics (Ambient Temperature T = 25 °C)

Parameter	Units	Min.	Typ.	Max.
Frequency Range (f)	GHz	10.0	-	21.0
Input Return Loss (S11)	dB	-	12.0	-
Output Return Loss (S22)	dB	-	12.0	-
Small Signal Gain (S21)	dB	-	17.0	-
Gain Flatness ($\Delta S21$)	dB	-	+/-2.0	-
Reverse Isolation (S12)	dB	-	65.0	-
Noise Figure	dB	-	4.5	-
Output Power for 1dB Compression (P1dB)	dBm	-	+19.0	-
Saturated Output Power (Psat)	dBm	-	+20.0	-
Output Third Order Intercept	dBm	-	+32.0	-
Drain Bias Voltage (Vd)	VDC	-	+4.0	+5.5
Gate Bias Voltage (Vg)	VDC	-1.0	-0.1	0.0
Supply Current (Id) (Vd=4.0V, Vg2=-0.5V Typical)	mA	-	90	-

Mimix Broadband, Inc., 10795 Rockley Rd., Houston, Texas 77099
Tel: 281.988.4600 Fax: 281.988.4615 mimixbroadband.com

Page 1 of 6

Characteristic Data and Specifications are subject to change without notice. ©2007 Mimix Broadband, Inc.
Export of this item may require appropriate export licensing from the U.S. Government. In purchasing these parts, U.S. Domestic customers accept their obligation to be compliant with U.S. Export Laws.

www.DataSheet4U.com

10.0-21.0 GHz GaAs MMIC Buffer Amplifier, QFN

September 2007 - Rev 12-Sep-07

Buffer Amplifier Measurements

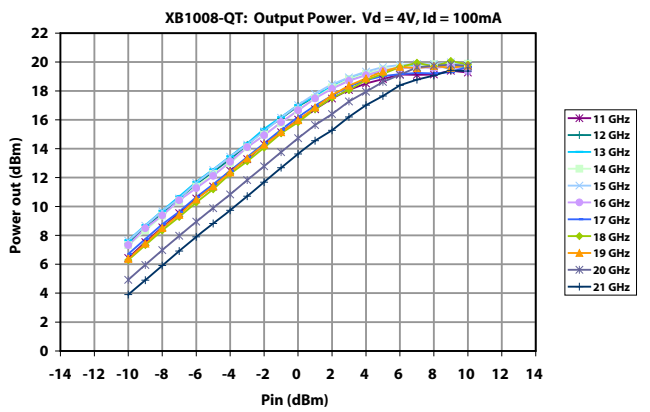
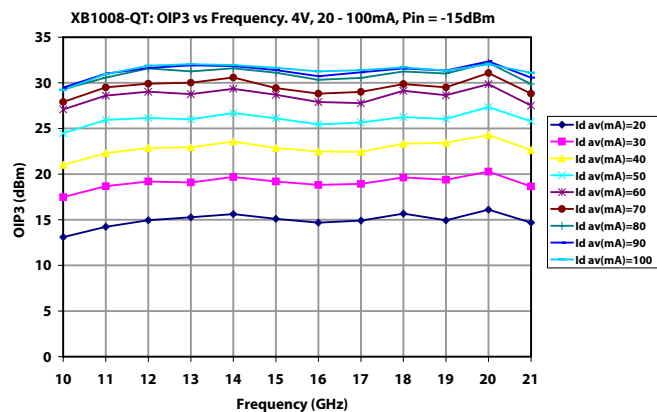
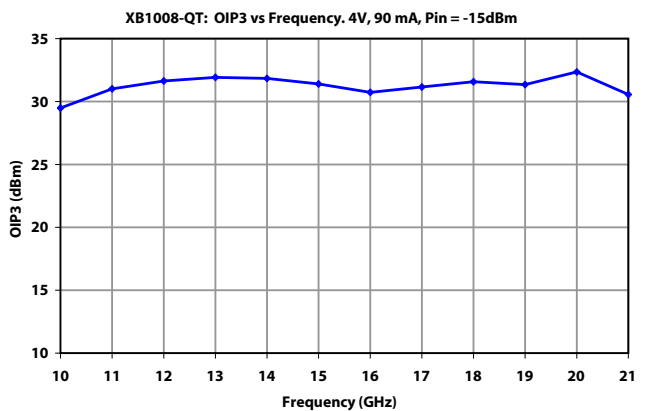
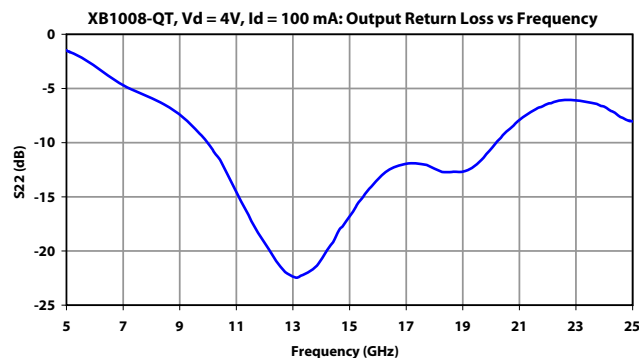
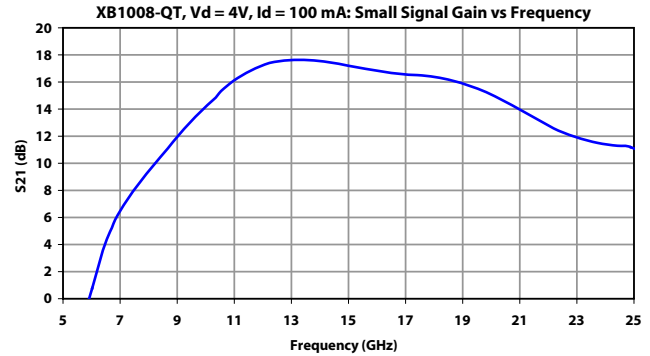
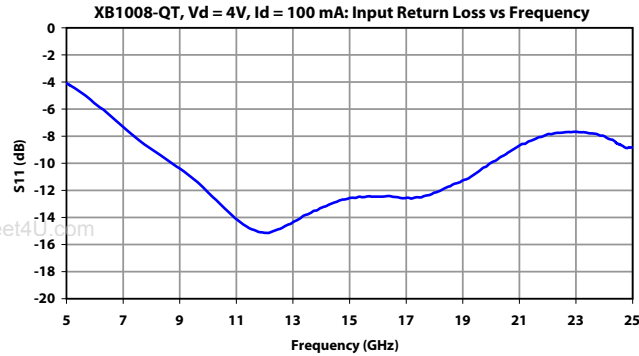

10.0-21.0 GHz GaAs MMIC Buffer Amplifier, QFN

September 2007 - Rev 12-Sep-07

Mimix
BROADBAND™

X B1008-QT
X RoHS

Buffer Amplifier Measurements (cont.)

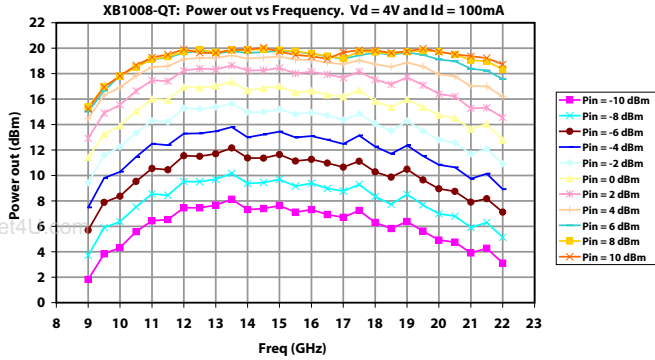

10.0-21.0 GHz GaAs MMIC Buffer Amplifier, QFN

September 2007 - Rev 12-Sep-07

Package Dimensions / Layout

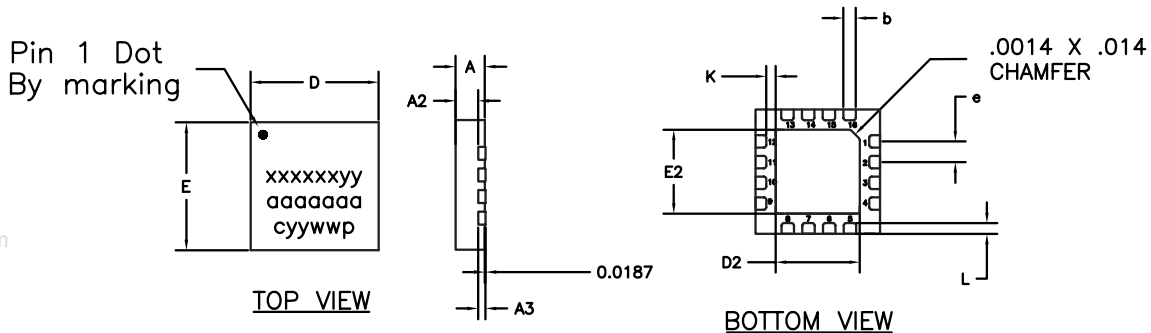

RECOMMENDED SOLDER PAD PITCH AND DIMENSIONS

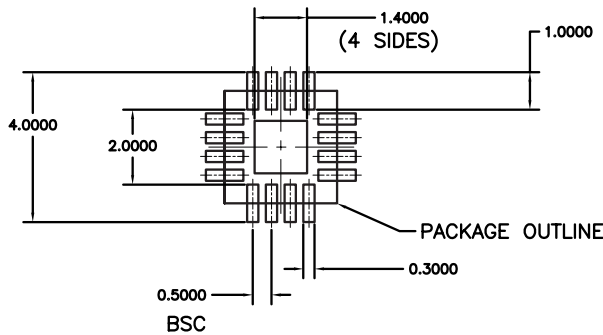

Note:

1. ALL DIMENSIONS ARE IN mm.

	MIN	TYP	MAX
A	0.80	0.90	1.00
A3	0.20 REF		
A2	0.00	0.65	1.00
b	0.20	0.25	0.30
K	0.20	—	—
D	3.00 BSC		
E	300 BSC		
e	0.50		
D2	1.50	1.65	1.80
E2	1.50	1.65	1.80
L	0.16	0.26	0.36

Note: All unused GND pins should be tied to center ground on application board for best thermal conductivity.

Functional Block Diagram

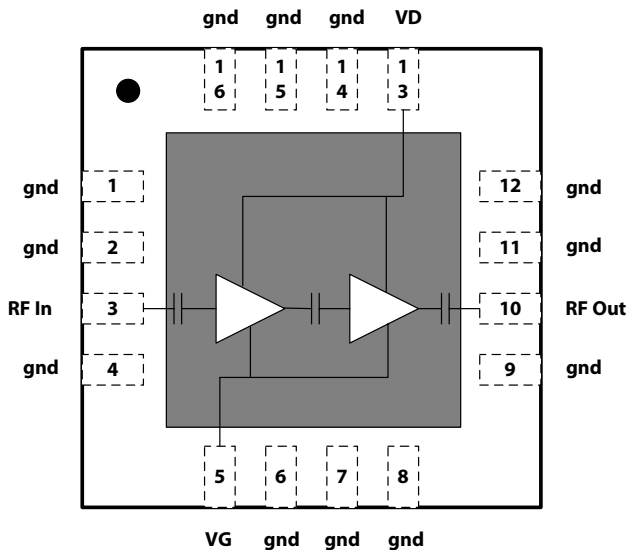

Pin Designations

Pin Number	Pin Name	Pin Function	Nominal Value
1-2	GND	Ground	
3	RF In	RF Input	
4	GND	Ground	
5	VG	Gate Bias	-0.5V
6-9	GND	Ground	
10	RF Out	RF Output	
11-12	GND	Ground	
13	VD	Drain Bias	4.5V, 130 mA
14-16	GND	Ground	

10.0-21.0 GHz GaAs MMIC Buffer Amplifier, QFN

September 2007 - Rev 12-Sep-07

App Note [1] Biasing - The device provides variable gain with adjustable bias regulation. For optimum linearity performance, it is recommended to bias this device at $V_d=4V$ with $I_d=90\text{ mA}$. It is also recommended to use active biasing to control the drain currents because this gives the most reproducible results over temperature or RF level variations. Depending on the supply voltage available and the power dissipation constraints, the bias circuit may be a single transistor or a low power operational amplifier, with a low value resistor in series with the drain supply used to sense the current. The gate of the pHEMT is controlled to maintain correct drain current and thus drain voltage. The typical gate voltage needed to do this is $-0.5V$. Typically the gate is protected with Silicon diodes to limit the applied voltage. Also, make sure to sequence the applied voltage to ensure negative gate bias is available before applying the positive drain supply.

MTTF Graphs

These numbers were calculated based on accelerated life test information and thermal model analysis received from the fabricating foundry.

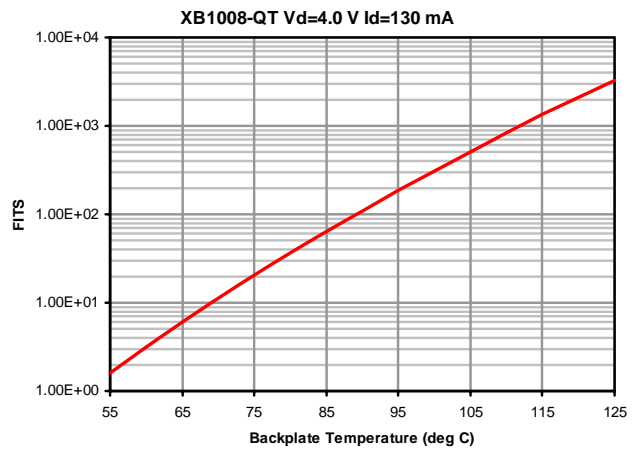
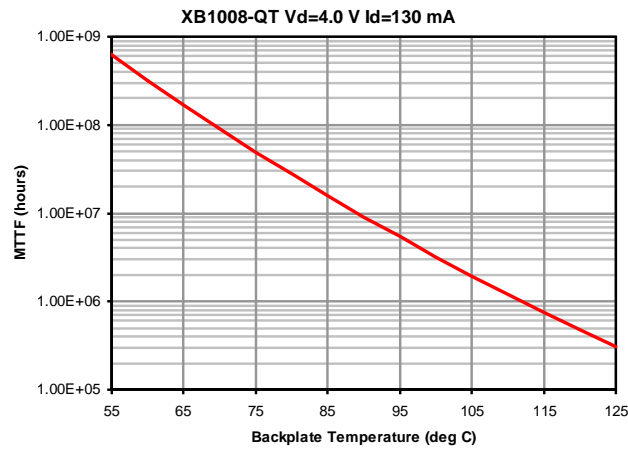

10.0-21.0 GHz GaAs MMIC Buffer Amplifier, QFN

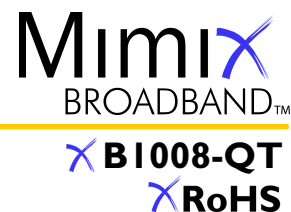

September 2007 - Rev 12-Sep-07

Handling and Assembly Information

CAUTION! - Mimix Broadband MMIC Products contain gallium arsenide (GaAs) which can be hazardous to the human body and the environment. For safety, observe the following procedures:

- Do not ingest.
- Do not alter the form of this product into a gas, powder, or liquid through burning, crushing, or chemical processing as these by-products are dangerous to the human body if inhaled, ingested, or swallowed.
- Observe government laws and company regulations when discarding this product. This product must be discarded in accordance with methods specified by applicable hazardous waste procedures.

Life Support Policy - Mimix Broadband's products are not authorized for use as critical components in life support devices or systems without the express written approval of the President and General Counsel of Mimix Broadband. As used herein: (1) Life support devices or systems are devices or systems which, (a) are intended for surgical implant into the body, or (b) support or sustain life, and whose failure to perform when properly used in accordance with instructions for use provided in the labeling, can be reasonably expected to result in a significant injury to the user. (2) A critical component is any component of a life support device or system whose failure to perform can be reasonably expected to cause the failure of the life support device or system, or to affect its safety or effectiveness.

Package Attachment - This packaged product from Mimix Broadband is provided as a rugged surface mount package compatible with high volume solder installation. Vacuum tools or other suitable pick and place equipment may be used to pick and place this part. Care should be taken to ensure that there are no voids or gaps in the solder connection so that good RF, DC and ground connections are maintained. Voids or gaps can eventually lead not only to RF performance degradation, but reduced reliability and life of the product due to thermal stress.

Typical Reflow Profiles

Reflow Profile	SnPb	Pb Free
Ramp Up Rate	3-4 °C/sec	3-4 °C/sec
Activation Time and Temperature	60-120 sec @ 140-160 °C	60-180 sec @ 170-200 °C
Time Above Melting Point	60-150 sec	60-150 sec
Max Peak Temperature	240 °C	265 °C
Time Within 5 °C of Peak	10-20 sec	10-20 sec
Ramp Down Rate	4-6 °C/sec	4-6 °C/sec

Factory Automation and Identification

Mimix Designator	Package Type	Number of leads offered	W Tape Width	P ₁ Component Pitch	P ₀ Hole Pitch	Reel Diameter	Units per Reel
-QT	QFN (3x3mm)	16	12mm	8mm	4mm	329mm (13in)	2000

Component Orientation: Parts are to be oriented with the PIN 1 closest to the tape's round sprocket holes on the tape's trailing edge.

Note: Tape and Reel packaging is ordered with a -000T suffix. Package is available in 500 unit reels through designated sales channels. Minimum order quantities should be discussed with your local sales representative.

Mimix Lead-Free RoHS Compliant Program - Mimix has an active program in place to meet customer and governmental requirements for eliminating lead (Pb) and other environmentally hazardous materials from our products. All Mimix RoHS compliant components are form, fit and functional replacements for their non-RoHS equivalents. Lead plating of our RoHS compliant parts is 100% matte tin (Sn) over copper alloy and is backwards compatible with current standard SnPb low-temperature reflow processes as well as higher temperature (260°C reflow) "Pb Free" processes.

Part Number for Ordering

XB1008-QT-0G00
XB1008-QT-0G0T
XB1008-QT-EV1

Description

Matte Tin plated RoHS compliant 3x3 16L QFN surface mount package in bulk quantity
Matte Tin plated RoHS compliant 3x3 16L QFN surface mount package in tape and reel
XB1008-QT evaluation board

Mimix Broadband, Inc., 10795 Rockley Rd., Houston, Texas 77099
Tel: 281.988.4600 Fax: 281.988.4615 mimixbroadband.com

Page 6 of 6

Characteristic Data and Specifications are subject to change without notice. ©2007 Mimix Broadband, Inc.
Export of this item may require appropriate export licensing from the U.S. Government. In purchasing these parts, U.S. Domestic customers accept their obligation to be compliant with U.S. Export Laws.