



## 28F016SA 16-MBIT (1 MBIT X 16, 2 MBIT X 8) FlashFile™ MEMORY

*Includes Commercial and Extended Temperature Specifications*

- User-Selectable 3.3V or 5V V<sub>CC</sub>
- User-Configurable x8 or x16 Operation
- 70 ns Maximum Access Time
- 28.6 MB/sec Burst Write Transfer Rate
- 1 Million Typical Erase Cycles per Block
- 56-Lead, 1.2 mm x 14 mm x 20 mm TSOP Package
- 56-Lead, 1.8 mm x 16 mm x 23.7 mm SSOP Package
- Revolutionary Architecture
  - Pipelined Command Execution
  - Program during Erase
  - Command Superset of Intel 28F008SA
- 1 mA Typical I<sub>CC</sub> in Static Mode
- 1 μA Typical Deep Power-Down
- 32 Independently Lockable Blocks
- State-of-the-Art 0.6 μm ETOX™ IV Flash Technology

Intel's 28F016SA 16-Mbit FlashFile™ memory is a revolutionary architecture which is the ideal choice for designing embedded direct-execute code and mass storage data/file flash memory systems. With innovative capabilities, low-power, extended temperature operation and high read/program performance, the 28F016SA enables the design of truly mobile, high-performance communications and computing products.

The 28F016SA is the highest density, highest performance nonvolatile read/program solution for solid-state storage applications. Its symmetrically-blocked architecture (100% compatible with the 28F008SA 8-Mbit FlashFile memory), extended cycling, extended temperature operation, flexible V<sub>CC</sub>, fast program and read performance and selective block locking provide highly flexible memory components suitable for Resident Flash Arrays, high-density memory cards and PCMCIA-ATA flash drives. The 28F016SA dual read voltage enables the design of memory cards which can be interchangeably read/written in 3.3V and 5.0V systems. Its x8/x16 architecture allows optimization of the memory-to-processor interface. Its high read performance and flexible block locking enable both storage and execution of operating systems and application software. Manufactured on Intel's 0.6 μm ETOX IV process technology, the 28F016SA is the most cost-effective, highest density monolithic 3.3V FlashFile memory.

---

Information in this document is provided in connection with Intel products. No license, express or implied, by estoppel or otherwise, to any intellectual property rights is granted by this document. Except as provided in Intel's Terms and Conditions of Sale for such products, Intel assumes no liability whatsoever, and Intel disclaims any express or implied warranty, relating to sale and/or use of Intel products including liability or warranties relating to fitness for a particular purpose, merchantability, or infringement of any patent, copyright or other intellectual property right. Intel products are not intended for use in medical, life saving, or life sustaining applications.

Intel may make changes to specifications and product descriptions at any time, without notice.

The 28F016SA may contain design defects or errors known as errata. Current characterized errata are available upon request.

\*Third-party brands and names are the property of their respective owners.

Contact your local Intel sales office or your distributor to obtain the latest specifications and before placing your product order.

Copies of documents which have an ordering number and are referenced in this document, or other Intel literature, may be obtained from:

Intel Corporation  
P.O. Box 7641  
Mt. Prospect, IL 60056-7641

or call 1-800-879-4683

COPYRIGHT © INTEL CORPORATION, 1996

CG-041493

# CONTENTS

	PAGE		PAGE
<b>1.0 INTRODUCTION</b> .....	<b>5</b>	5.6 AC Characteristics—Read Only Operations.....	32
1.1 Product Overview .....	5	5.7 Power-Up and Reset Timings.....	37
<b>2.0 DEVICE PINOUT</b> .....	<b>6</b>	5.8 AC Characteristics for WE#—Controlled Command Write Operations .....	38
2.1 Lead Descriptions .....	8	5.9 AC Characteristics for CE#—Controlled Command Write Operations .....	42
<b>3.0 MEMORY MAPS</b> .....	<b>12</b>	5.10 AC Characteristics for Page Buffer Write Operations.....	46
3.1 Extended Status Register Memory Map.....	13	5.11 Erase and Word/Byte Program Performance, Cycling Performance and Suspend Latency.....	49
<b>4.0 BUS OPERATIONS, COMMANDS AND STATUS REGISTER DEFINITIONS</b> .....	<b>14</b>	<b>6.0 DERATING CURVES</b> .....	<b>50</b>
4.1 Bus Operations for Word-Wide Mode (BYTE# = V <sub>IH</sub> ).....	14	<b>7.0 MECHANICAL SPECIFICATIONS FOR TSOP</b> .....	<b>52</b>
4.2 Bus Operations for Byte-Wide Mode (BYTE# = V <sub>IL</sub> ) .....	14	<b>8.0 MECHANICAL SPECIFICATIONS FOR SSOP</b> .....	<b>53</b>
4.3 28F008SA—Compatible Mode Command Bus Definitions.....	15	<b>APPENDIX A: Device Nomenclature and Ordering Information</b> .....	<b>54</b>
4.4 28F016SA—Performance Enhancement Command Bus Definitions.....	16	<b>APPENDIX B: Additional Information</b> .....	<b>55</b>
4.5 Compatible Status Register .....	18		
4.6 Global Status Register .....	19		
4.7 Block Status Register .....	20		
<b>5.0 ELECTRICAL SPECIFICATIONS</b> .....	<b>21</b>		
5.1 Absolute Maximum Ratings .....	21		
5.2 Capacitance.....	22		
5.3 Timing Nomenclature.....	23		
5.4 DC Characteristics (V <sub>CC</sub> = 3.3V ± 10%).....	26		
5.5 DC Characteristics (V <sub>CC</sub> = 5.0V ± 10%, 5.0V ± 5%) .....	29		



## REVISION HISTORY

Number	Description
-001	Original Version
-002	<ul style="list-style-type: none"> <li>— Added 56-Lead SSOP Package</li> <li>— Separated AC Reading Timing Specs <math>t_{AVEL}</math>, <math>t_{AVGL}</math> for Extended Status Register Reads</li> <li>— Modified Device Nomenclature</li> <li>— Added Ordering Information</li> <li>— Added Page Buffer Typical Program Performance numbers</li> <li>— Added Typical Erase Suspend Latencies</li> <li>— For <math>I_{CCD}</math> (Deep Power-Down current) BYTE# must be at CMOS levels</li> <li>— Added SSOP package mechanical specifications</li> <li>— Revised document status from “Advanced Information” to “Preliminary”</li> </ul>
-003	<ul style="list-style-type: none"> <li>— Section 5.11: Renamed specification “Erase Suspend Latency Time to Program” as “Auto Erase Suspend Latency Time to Program”</li> <li>— Section 5.7: Added specifications <math>t_{PHEL3}</math>, <math>t_{PHEL5}</math></li> <li>— TSOP dimension <math>A_1 = 0.05</math> mm (min)</li> <li>— SSOP dimension B = 0.40 mm (max)</li> <li>— Minor cosmetic changes</li> </ul>
-004	Update: <ul style="list-style-type: none"> <li>— Changed Deep Power Down Current</li> <li>— Changed Standby Current</li> <li>— Changed Sleep Mode Current</li> </ul> Combined Commercial and Extended Temperature information into single datasheet

## 1.0 INTRODUCTION

The documentation of the Intel 28F016SA memory device includes this datasheet, a detailed user's manual, and a number of application notes, all of which are referenced at the end of this datasheet.

The datasheet is intended to give an overview of the chip feature-set and of the operating AC/DC specifications. *The 16-Mbit Flash Product Family User's Manual* provides complete descriptions of the user modes, system interface examples and detailed descriptions of all principles of operation. It also contains the full list of software algorithm flowcharts, and a brief section on compatibility with Intel 28F008SA.

### 1.1 Product Overview

The 28F016SA is a high-performance 16-Mbit (16,777,216 bit) block erasable nonvolatile random access memory organized as either 1 Mword x 16 or 2 Mbyte x 8. The 28F016SA includes thirty-two 64-KB (65,536) blocks or thirty-two 32-KW (32,768) blocks. A chip memory map is shown in Figure 4.

The implementation of a new architecture, with many enhanced features, will improve the device operating characteristics and results in greater product reliability and ease-of-use.

Among the significant enhancements on the 28F016SA:

- 3.3V Low Power Capability
- Improved Program Performance
- Dedicated Block Program/Erase Protection

A 3/5# input pin reconfigures the device internally for optimized 3.3V or 5.0V read/program operation.

The 28F016SA will be available in a 56-lead, 1.2 mm thick, 14 mm x 20 mm TSOP type I package or a 56-lead, 1.8 mm thick, 16 mm x 23.7 mm SSOP package. The TSOP form factor and pinout allow for very high board layout densities. SSOP packaging provides relaxed lead spacing dimensions.

A Command User Interface (CUI) serves as the system interface between the microprocessor or microcontroller and the internal memory operation.

Internal algorithm automation allows word/byte programs and block erase operations to be executed using a two-write command sequence to the CUI in the same way as the 28F008SA 8-Mbit FlashFile memory.

A superset of commands have been added to the basic 28F008SA command-set to achieve higher program performance and provide additional capabilities. These new commands and features include:

- Page Buffer Writes to Flash
- Command Queueing Capability
- Automatic Data Programs during Erase
- Software Locking of Memory Blocks
- Two-Byte Successive Programs in 8-bit Systems
- Erase All Unlocked Blocks

Writing of memory data is performed in either byte or word increments typically within 6  $\mu$ s, a 33% improvement over the 28F008SA. A block erase operation erases one of the 32 blocks in typically 0.6 sec, independent of the other blocks, which is a 65% improvement over the 28F008SA.

Each block can be written and erased a minimum of 100,000 cycles. Systems can achieve typically one-million block erase cycles by providing wear-leveling algorithms and graceful block retirement. These techniques have already been employed in many flash file systems. Additionally, wear leveling of block erase cycles can be used to minimize the program/erase performance differences across blocks.

The 28F016SA incorporates two Page Buffers of 256 bytes (128 words) each to allow page data writes. This feature can improve a system write performance by up to 4.8 times over previous flash memory devices.

All operations are started by a sequence of command writes to the device. Three Status Registers (described in detail later) and a RY/BY# output pin provide information on the progress of the requested operation.

While the 28F008SA requires an operation to complete before the next operation can be requested, the 28F016SA allows queueing of the next operation while the memory executes the current operation. This eliminates system overhead

when writing several bytes in a row to the array or erasing several blocks at the same time. The 28F016SA can also perform program operations to one block of memory while performing erase of another block.

The 28F016SA provides user-selectable block locking to protect code or data such as device drivers, PCMCIA card information, ROM-executable O/S or application code. Each block has an associated nonvolatile lock-bit which determines the lock status of the block. In addition, the 28F016SA has a master Write Protect pin (WP#) which prevents any modifications to memory blocks whose lock-bits are set.

The 28F016SA contains three types of Status Registers to accomplish various functions:

- A Compatible Status Register (CSR) which is 100% compatible with the 28F008SA FlashFile memory's Status Register. This register, when used alone, provides a straightforward upgrade capability to the 28F016SA from a 28F008SA-based design.
- A Global Status Register (GSR) which informs the system of Command Queue status, Page Buffer status, and overall Write State Machine (WSM) status.
- 32 Block Status Registers (BSRs) which provide block-specific status information such as the block lock-bit status.

The GSR and BSR memory maps for byte-wide and word-wide modes are shown in Figures 5 and 6.

The 28F016SA incorporates an open drain RY/BY# output pin. This feature allows the user to OR-tie many RY/BY# pins together in a multiple memory configuration such as a Resident Flash Array.

Other configurations of the RY/BY# pin are enabled via special CUI commands and are described in detail in the *16-Mbit Flash Product Family User's Manual*.

The 28F016SA also incorporates a dual chip-enable function with two input pins, CE<sub>0</sub># and CE<sub>1</sub>#. These pins have exactly the same functionality as the regular chip-enable pin CE# on the 28F008SA. For minimum chip designs, CE<sub>1</sub># may be tied to ground to use CE<sub>0</sub># as the chip enable input. The 28F016SA uses the logical combination of these

two signals to enable or disable the entire chip. Both CE<sub>0</sub># and CE<sub>1</sub># must be active low to enable the device and, if either one becomes inactive, the chip will be disabled. This feature, along with the open drain RY/BY# pin, allows the system designer to reduce the number of control pins used in a large array of 16-Mbit devices.

The BYTE# pin allows either x8 or x16 read/programs to the 28F016SA. BYTE# at logic low selects 8-bit mode with address A<sub>0</sub> selecting between low byte and high byte. On the other hand, BYTE# at logic high enables 16-bit operation with address A<sub>1</sub> becoming the lowest order address and address A<sub>0</sub> is not used (don't care). A device block diagram is shown in Figure 1.

The 28F016SA is specified for a maximum access time of 70 ns (t<sub>ACC</sub>) at 5.0V operation (4.75V to 5.25V) over the commercial temperature range (0°C to +70°C). A corresponding maximum access time of 120 ns at 3.3V (3.0V to 3.6V and 0°C to +70°C) is achieved for reduced power consumption applications.

The 28F016SA incorporates an Automatic Power Saving (APS) feature which substantially reduces the active current when the device is in the static mode of operation (addresses not switching).

In APS mode, the typical I<sub>CC</sub> current is 1 mA at 5.0V (0.8 mA at 3.3V).

A deep power-down mode of operation is invoked when the RP# (called PWD# on the 28F008SA) pin transitions low. This mode brings the device power consumption to less than 1.0 μA, typically, and provides additional write protection by acting as a device reset pin during power transitions. A reset time is required from RP# switching high until outputs are again valid. In the deep power-down state, the WSM is reset (any current operation will abort) and the CSR, GSR and BSR registers are cleared.

A CMOS standby mode of operation is enabled when either CE<sub>0</sub># or CE<sub>1</sub># transitions high and RP# stays high with all input control pins at CMOS levels. In this mode, the device typically draws an I<sub>CC</sub> standby current of 50 μA.

## 2.0 DEVICE PINOUT

The 28F016SA 56-lead TSOP Type I pinout configuration is shown in Figure 2. The 56-lead SSOP pinout configuration is shown in Figure 3.

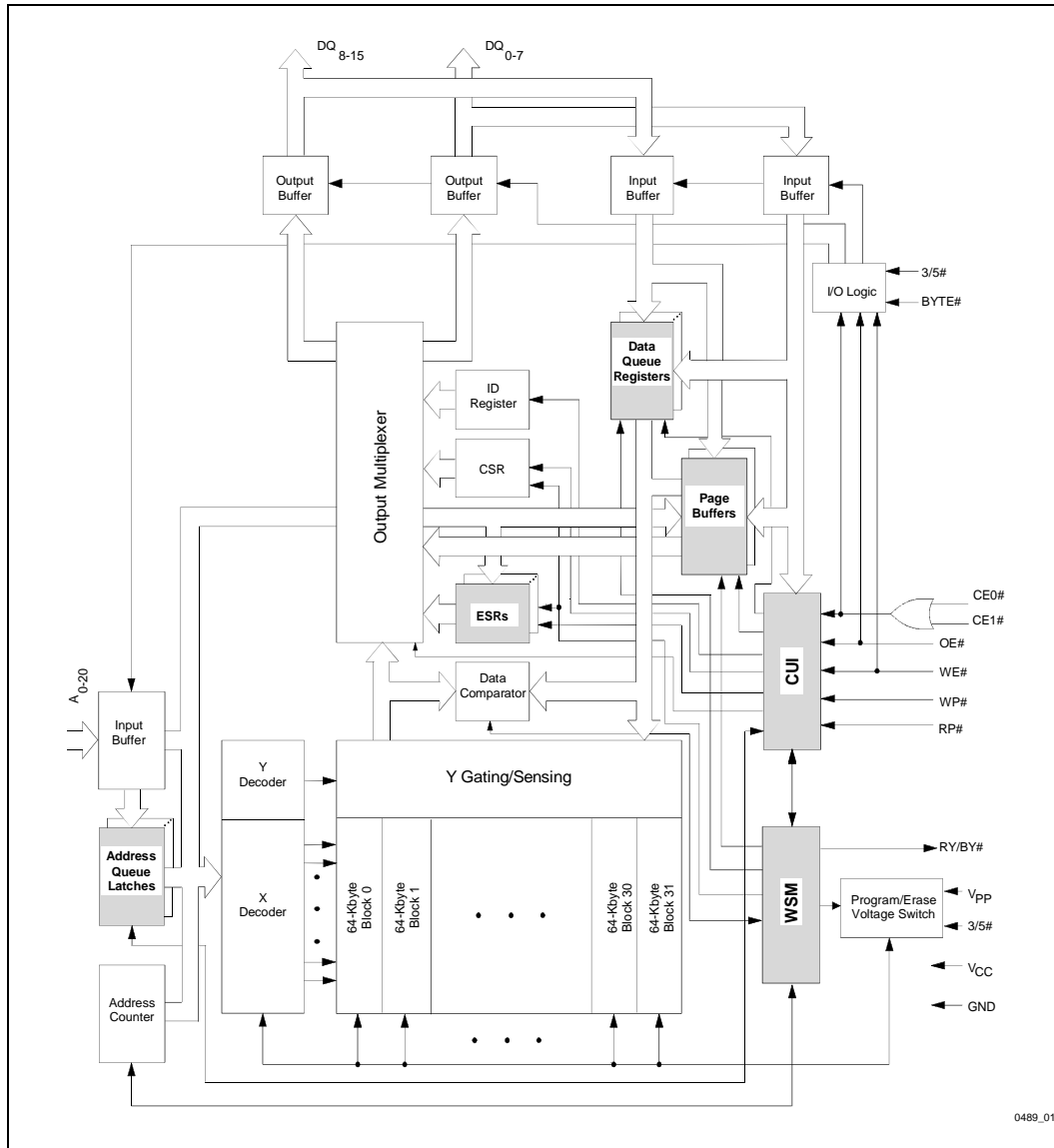

**Figure 1. 28F016SA Block Diagram**  
**Architectural Evolution Includes Page Buffers, Queue Registers and Extended Status Registers**

## 2.1 Lead Descriptions

Symbol	Type	Name and Function
A <sub>0</sub>	INPUT	<b>BYTE-SELECT ADDRESS:</b> Selects between high and low byte when the device is in x8 mode. This address is latched in x8 data programs. Not used in x16 mode (i.e., the A <sub>0</sub> input buffer is turned off when BYTE# is high).
A <sub>1–A15</sub>	INPUT	<b>WORD-SELECT ADDRESSES:</b> Select a word within one 64-Kbyte block. A <sub>6–15</sub> selects 1 of 1024 rows, and A <sub>1–5</sub> selects 16 of 512 columns. These addresses are latched during data programs.
A <sub>16–A20</sub>	INPUT	<b>BLOCK-SELECT ADDRESSES:</b> Select 1 of 32 erase blocks. These addresses are latched during data programs, block erase and lock block operations.
DQ <sub>0–DQ7</sub>	INPUT/OUTPUT	<b>LOW-BYTE DATA BUS:</b> Inputs data and commands during CUI write cycles. Outputs array, buffer, identifier or status data in the appropriate read mode. Floated when the chip is deselected or the outputs are disabled.
DQ <sub>8–DQ15</sub>	INPUT/OUTPUT	<b>HIGH-BYTE DATA BUS:</b> Inputs data during x16 data program operations. Outputs array, buffer or identifier data in the appropriate read mode; not used for Status Register reads. Floated when the chip is deselected or the outputs are disabled.
CE <sub>0#</sub> , CE <sub>1#</sub>	INPUT	<b>CHIP ENABLE INPUTS:</b> Activate the device's control logic, input buffers, decoders and sense amplifiers. With either CE <sub>0#</sub> or CE <sub>1#</sub> high, the device is deselected and power consumption reduces to standby levels upon completion of any current data program or block erase operations. Both CE <sub>0#</sub> , CE <sub>1#</sub> must be low to select the device. All timing specifications are the same for both signals. Device selection occurs with the latter falling edge of CE <sub>0#</sub> or CE <sub>1#</sub> . The first rising edge of CE <sub>0#</sub> or CE <sub>1#</sub> disables the device.
RP#	INPUT	<b>RESET/POWER-DOWN:</b> RP# low places the device in a deep power-down state. All circuits that burn static power, even those circuits enabled in standby mode, are turned off. When returning from deep power-down, a recovery time is required to allow these circuits to power-up. When RP# goes low, any current or pending WSM operation(s) are terminated, and the device is reset. All Status Registers return to ready (with all status flags cleared).
OE#	INPUT	<b>OUTPUT ENABLE:</b> Gates device data through the output buffers when low. The outputs float to tri-state off when OE# is high. <b>NOTE:</b> CE <sub>x#</sub> overrides OE#, and OE# overrides WE#.
WE#	INPUT	<b>WRITE ENABLE:</b> Controls access to the CUI, Page Buffers, Data Queue Registers and Address Queue Latches. WE# is active low, and latches both address and data (command or array) on its rising edge. Page Buffer addresses are latched on the falling edge of WE#.



## 2.1 Lead Descriptions (Continued)

Symbol	Type	Name and Function
RY/BY#	OPEN DRAIN OUTPUT	<b>READY/BUSY:</b> Indicates status of the internal WSM. When low, it indicates that the WSM is busy performing an operation. RY/BY# high indicates that the WSM is ready for new operations (or WSM has completed all pending operations), or block erase is suspended, or the device is in deep power-down mode. This output is always active (i.e., not floated to tri-state off when OE# or CE <sub>0</sub> #,CE <sub>1</sub> # are high), except if a RY/BY# Pin Disable command is issued.
WP#	INPUT	<b>WRITE PROTECT:</b> Erase blocks can be locked by writing a nonvolatile lock-bit for each block. When WP# is low, those locked blocks as reflected by the Block-Lock Status bits (BSR.6), are protected from inadvertent data programs or block erases. When WP# is high, all blocks can be written or erased regardless of the state of the lock-bits. The WP# input buffer is disabled when RP# transitions low (deep power-down mode).
BYTE#	INPUT	<b>BYTE ENABLE:</b> BYTE# low places device in x8 mode. All data is then input or output on DQ <sub>0-7</sub> , and DQ <sub>8-15</sub> float. Address A <sub>0</sub> selects between the high and low byte. BYTE# high places the device in x16 mode, and turns off the A <sub>0</sub> input buffer. Address A <sub>1</sub> then becomes the lowest order address.
3/5#	INPUT	<b>3.3/5.0 VOLT SELECT:</b> 3/5# high configures internal circuits for 3.3V operation. 3/5# low configures internal circuits for 5.0V operation.  <b>NOTES:</b>  Reading the array with 3/5# high in a 5.0V system could damage the device. There is a significant delay from 3/5# switching to valid data.
V <sub>PP</sub>	SUPPLY	<b>ERASE/PROGRAM POWER SUPPLY:</b> For erasing memory array blocks or writing words/bytes/pages into the flash array.
V <sub>CC</sub>	SUPPLY	<b>DEVICE POWER SUPPLY (3.3V ± 10%, 5.0V ± 10%, 5.0V ± 5%):</b> Do not leave any power pins floating.
GND	SUPPLY	<b>GROUND FOR ALL INTERNAL CIRCUITRY:</b> Do not leave any ground pins floating.
NC		<b>NO CONNECT:</b> Lead may be driven or left floating.

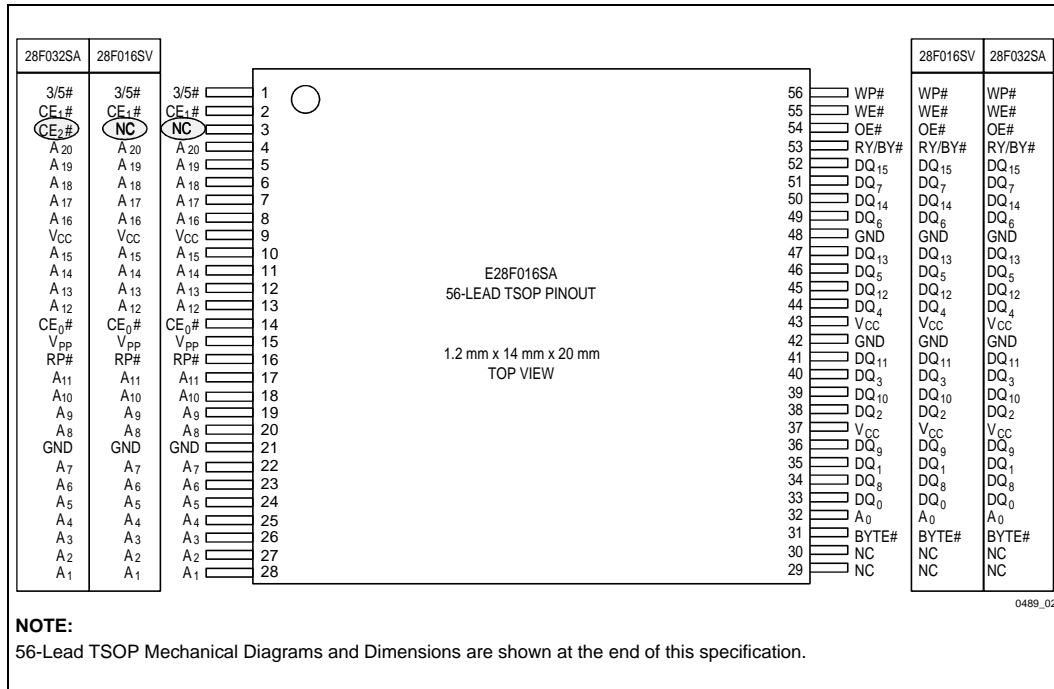

Figure 2. TSOP Pinout Configuration

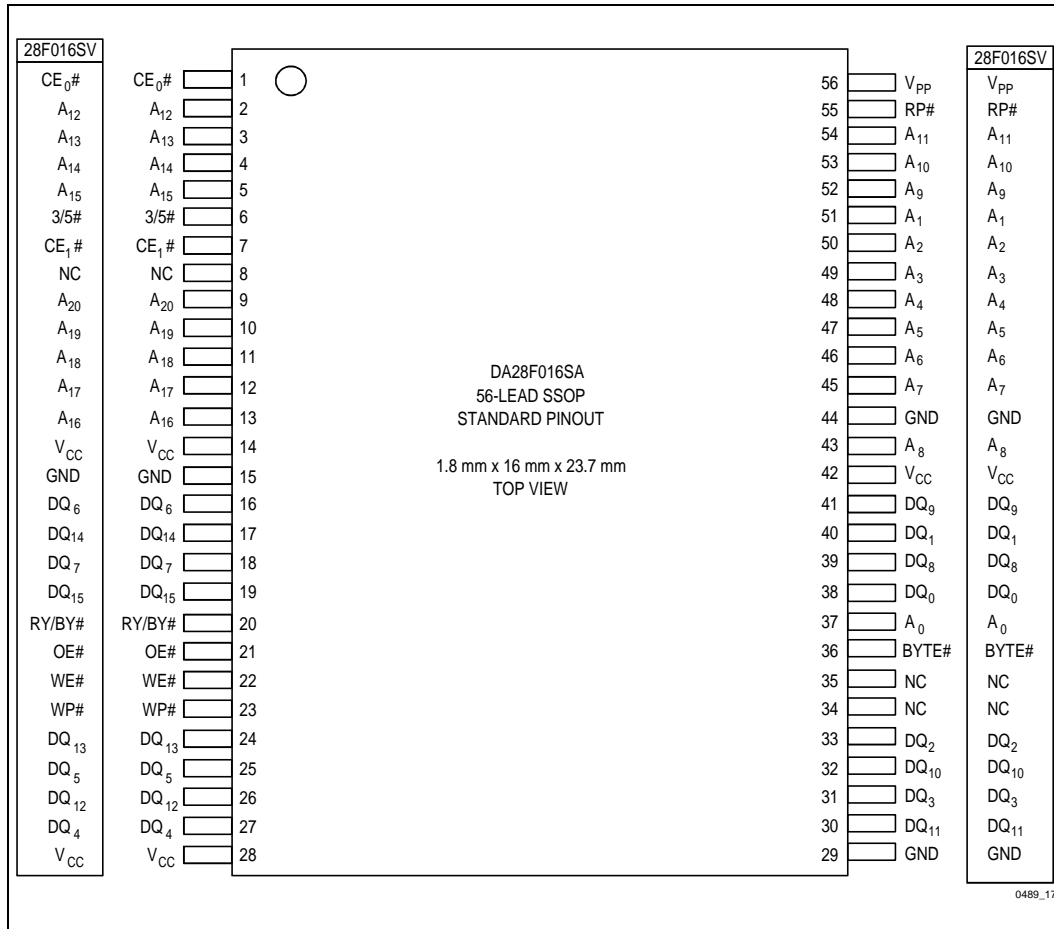

Figure 3. SSOP Pinout Configuration

## 3.0 MEMORY MAPS

A <sub>[20-0]</sub>		
1FFFFF	64-Kbyte Block	31
1F0000		
1EFFFF	64-Kbyte Block	30
1E0000		
1DFFFF	64-Kbyte Block	29
1D0000		
1CFFFF	64-Kbyte Block	28
1C0000		
1BFFFF	64-Kbyte Block	27
1B0000		
1AFFFF	64-Kbyte Block	26
1A0000		
19FFFF	64-Kbyte Block	25
190000		
18FFFF	64-Kbyte Block	24
180000		
17FFFF	64-Kbyte Block	23
170000		
16FFFF	64-Kbyte Block	22
160000		
15FFFF	64-Kbyte Block	21
150000		
14FFFF	64-Kbyte Block	20
140000		
13FFFF	64-Kbyte Block	19
130000		
12FFFF	64-Kbyte Block	18
120000		
11FFFF	64-Kbyte Block	17
110000		
10FFFF	64-Kbyte Block	16
100000		
0FFFFF	64-Kbyte Block	15
0F0000		
0EFFFF	64-Kbyte Block	14
0E0000		
0DFFFF	64-Kbyte Block	13
0D0000		
0CFFFF	64-Kbyte Block	12
0C0000		
0BFFFF	64-Kbyte Block	11
0B0000		
0AFFFF	64-Kbyte Block	10
0A0000		
09FFFF	64-Kbyte Block	9
090000		
08FFFF	64-Kbyte Block	8
080000		
07FFFF	64-Kbyte Block	7
070000		
06FFFF	64-Kbyte Block	6
060000		
05FFFF	64-Kbyte Block	5
050000		
04FFFF	64-Kbyte Block	4
040000		
03FFFF	64-Kbyte Block	3
030000		
02FFFF	64-Kbyte Block	2
020000		
01FFFF	64-Kbyte Block	1
010000		
00FFFF	64-Kbyte Block	0
000000		

0489\_03

Figure 4. 28F016SA Memory Map (Byte-Wide Mode)

3.1 Extended Status Register Memory Map

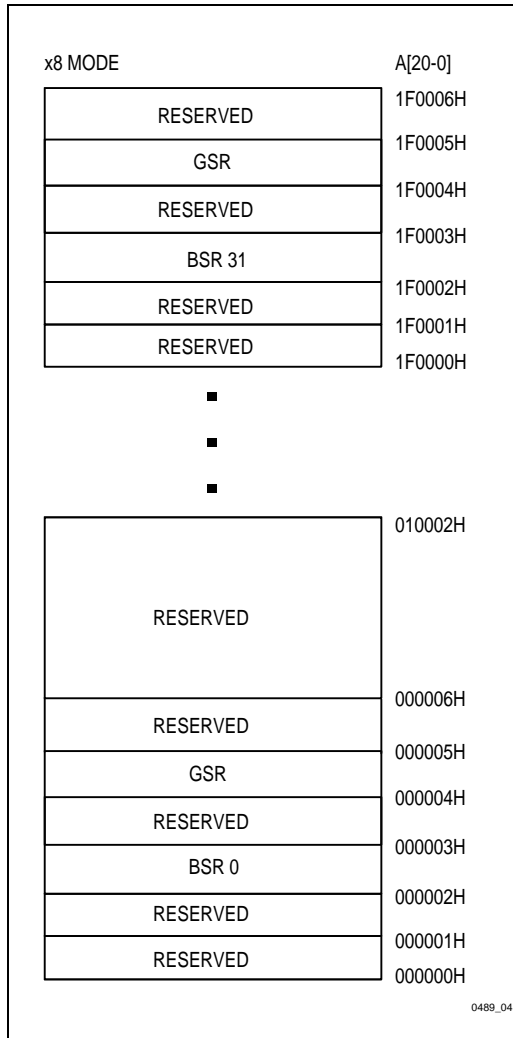

Figure 5. Extended Status Register Memory Map (Byte-Wide Mode)

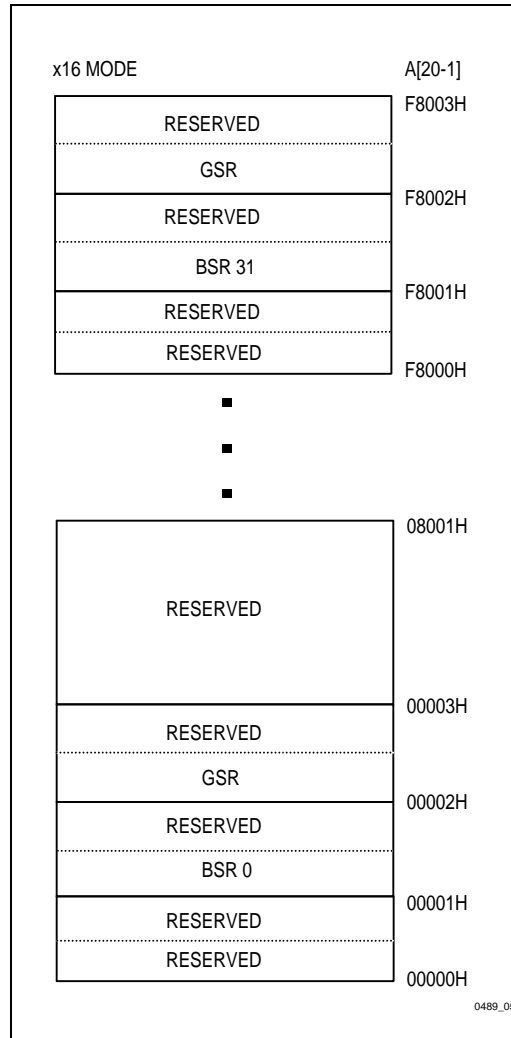

Figure 6. Extended Status Register Memory Map (Word-Wide Mode)



## 4.0 BUS OPERATIONS, COMMANDS AND STATUS REGISTER DEFINITIONS

### 4.1 Bus Operations for Word-Wide Mode (BYTE# = V<sub>IH</sub>)

Mode	Notes	RP#	CE <sub>1</sub> #	CE <sub>0</sub> #	OE#	WE#	A <sub>1</sub>	DQ <sub>0-15</sub>	RY/BY#
Read	1,2,7	V <sub>IH</sub>	V <sub>IL</sub>	V <sub>IL</sub>	V <sub>IL</sub>	V <sub>IH</sub>	X	D <sub>OUT</sub>	X
Output Disable	1,6,7	V <sub>IH</sub>	V <sub>IL</sub>	V <sub>IL</sub>	V <sub>IH</sub>	V <sub>IH</sub>	X	High Z	X
Standby	1,6,7	V <sub>IH</sub>	V <sub>IL</sub> V <sub>IH</sub> V <sub>IH</sub>	V <sub>IH</sub> V <sub>IL</sub> V <sub>IH</sub>	X	X	X	High Z	X
Deep Power-Down	1,3	V <sub>IL</sub>	X	X	X	X	X	High Z	V <sub>OH</sub>
Manufacturer ID	4	V <sub>IH</sub>	V <sub>IL</sub>	V <sub>IL</sub>	V <sub>IL</sub>	V <sub>IH</sub>	V <sub>IL</sub>	0089H	V <sub>OH</sub>
Device ID	4	V <sub>IH</sub>	V <sub>IL</sub>	V <sub>IL</sub>	V <sub>IL</sub>	V <sub>IH</sub>	V <sub>IH</sub>	66A0H	V <sub>OH</sub>
Write	1,5,6	V <sub>IH</sub>	V <sub>IL</sub>	V <sub>IL</sub>	V <sub>IH</sub>	V <sub>IL</sub>	X	D <sub>IN</sub>	X

### 4.2 Bus Operations for Byte-Wide Mode (BYTE# = V<sub>IL</sub>)

Mode	Notes	RP#	CE <sub>1</sub> #	CE <sub>0</sub> #	OE#	WE#	A <sub>0</sub>	DQ <sub>0-7</sub>	RY/BY#
Read	1,2,7	V <sub>IH</sub>	V <sub>IL</sub>	V <sub>IL</sub>	V <sub>IL</sub>	V <sub>IH</sub>	X	D <sub>OUT</sub>	X
Output Disable	1,6,7	V <sub>IH</sub>	V <sub>IL</sub>	V <sub>IL</sub>	V <sub>IH</sub>	V <sub>IH</sub>	X	High Z	X
Standby	1,6,7	V <sub>IH</sub>	V <sub>IL</sub> V <sub>IH</sub> V <sub>IH</sub>	V <sub>IH</sub> V <sub>IL</sub> V <sub>IH</sub>	X	X	X	High Z	X
Deep Power-Down	1,3	V <sub>IL</sub>	X	X	X	X	X	High Z	V <sub>OH</sub>
Manufacturer ID	4	V <sub>IH</sub>	V <sub>IL</sub>	V <sub>IL</sub>	V <sub>IL</sub>	V <sub>IH</sub>	V <sub>IL</sub>	89H	V <sub>OH</sub>
Device ID	4	V <sub>IH</sub>	V <sub>IL</sub>	V <sub>IL</sub>	V <sub>IL</sub>	V <sub>IH</sub>	V <sub>IH</sub>	A0H	V <sub>OH</sub>
Write	1,5,6	V <sub>IH</sub>	V <sub>IL</sub>	V <sub>IL</sub>	V <sub>IH</sub>	V <sub>IL</sub>	X	D <sub>IN</sub>	X

#### NOTES:

- X can be V<sub>IH</sub> or V<sub>IL</sub> for address or control pins except for RY/BY#, which is either V<sub>OL</sub> or V<sub>OH</sub>.
- RY/BY# output is open drain. When the WSM is ready, block erase is suspended or the device is in deep power-down mode. RY/BY# will be at V<sub>OH</sub> if it is tied to V<sub>CC</sub> through a resistor. RY/BY# at V<sub>OH</sub> is independent of OE# while a WSM operation is in progress.
- RP# at GND ± 0.2V ensures the lowest deep power-down current.
- A<sub>0</sub> and A<sub>1</sub> at V<sub>IL</sub> provide manufacturer ID codes in x8 and x16 modes, respectively. A<sub>0</sub> and A<sub>1</sub> at V<sub>IH</sub> provide device ID codes in x8 and x16 modes, respectively. All other addresses are set to zero.
- Commands for different block erase operations, data program operations or lock-block operations can only be successfully completed when V<sub>PP</sub> = V<sub>PPH</sub>.
- While the WSM is running, RY/BY# in level-mode (default) stays at V<sub>OL</sub> until all operations are complete. RY/BY# goes to V<sub>OH</sub> when the WSM is not busy or in erase suspend mode.
- RY/BY# may be at V<sub>OL</sub> while the WSM is busy performing various operations; for example, a Status Register read during a data program operation.

### 4.3 28F008SA–Compatible Mode Command Bus Definitions

Command	Notes	First Bus Cycle			Second Bus Cycle		
		Oper	Addr	Data(4)	Oper	Addr	Data
Read Array		Write	X	xxFFH	Read	AA	AD
Intelligent Identifier	1	Write	X	xx90H	Read	IA	ID
Read Compatible Status Register	2	Write	X	xx70H	Read	X	CSRD
Clear Status Register	3	Write	X	xx50H			
Word/Byte Program		Write	X	xx40H	Write	PA	PD
Alternate Word/Byte Program		Write	X	xx10H	Write	PA	PD
Block Erase/Confirm		Write	X	xx20H	Write	BA	xxD0H
Erase Suspend/Resume		Write	X	xxB0H	Write	X	xxD0H

**ADDRESS**

A = Array Address  
 BA = Block Address  
 IA = Identifier Address  
 PA = Program Address  
 X = Don't Care

**DATA**

AD = Array Data  
 CSRD = CSR Data  
 ID = Identifier Data  
 PD = Program Data

**NOTES:**

- Following the Intelligent Identifier command, two read operations access the manufacturer and device signature codes.
- The CSR is automatically available after device enters data program, block erase, or suspend operations.
- Clears CSR.3, CSR.4 and CSR.5. Also clears GSR.5 and all BSR.5 and BSR.2 bits.
- The upper byte of the data bus (DQ<sub>8-15</sub>) during command writes is a "Don't Care" in x16 operation of the device.

See Status Register definitions.

## 4.4 28F016SA–Performance Enhancement Command Bus Definitions

Command	Mode	Notes	First Bus Cycle			Second Bus Cycle			Third Bus Cycle		
			Oper	Addr	Data <sup>(12)</sup>	Oper	Addr	Data <sup>(12)</sup>	Oper	Addr	Data
Read Extended Status Register		1	Write	X	xx71H	Read	RA	GSRD BSRD			
Page Buffer Swap		7	Write	X	xx72H						
Read Page Buffer			Write	X	xx75H	Read	PBA	PD			
Single Load to Page Buffer			Write	X	xx74H	Write	PBA	PD			
Sequential Load to Page Buffer	x8	4,6,10	Write	X	xxE0H	Write	X	BCL	Write	X	BCH
	x16	4,5,6,10	Write	X	xxE0H	Write	X	WCL	Write	X	WCH
Page Buffer Write to Flash	x8	3,4,9,10	Write	X	xx0CH	Write	A <sub>0</sub>	BC(L,H)	Write	PA	BC(H,L)
	x16	4,5,10	Write	X	xx0CH	Write	X	WCL	Write	PA	WCH
Two-Byte Program	x8	3	Write	X	xxFBH	Write	A <sub>0</sub>	WD(L,H)	Write	PA	WD(H,L)
Lock Block/Confirm			Write	X	xx77H	Write	BA	xxD0H			
Upload Status Bits/Confirm		2	Write	X	xx97H	Write	X	xxD0H			
Upload Device Information			Write	X	xx99H	Write	X	xxD0H			
Erase All Unlocked Blocks/Confirm			Write	X	xxA7H	Write	X	xxD0H			
RY/BY# Enable to Level-Mode		8	Write	X	xx96H	Write	X	xx01H			
RY/BY# Pulse-On-Write		8	Write	X	xx96H	Write	X	xx02H			
RY/BY# Pulse-On-Erase		8	Write	X	xx96H	Write	X	xx03H			
RY/BY# Disable		8	Write	X	xx96H	Write	X	xx04H			
Sleep		11	Write	X	xxF0H						
Abort			Write	X	xx80H						

**ADDRESS**

BA = Block Address  
PBA = Page Buffer Address  
RA = Extended Register Address  
PA = Program Address  
X = Don't Care

**DATA**

AD = Array Data  
PD = Page Buffer Data  
BSRD = BSR Data  
GSRD = GSR Data

WC (L,H) = Word Count (Low, High)  
BC (L,H) = Byte Count (Low, High)  
WD (L,H) = Write Data (Low, High)



## NOTES:

1. RA can be the GSR address or any BSR address. See Figures 5 and 6 for Extended Status Register Memory Maps.
2. Upon device power-up, all BSR lock-bits come up locked. The Upload Status Bits command must be written to reflect the actual lock-bit status.
3.  $A_0$  is automatically complemented to load the second byte of data. BYTE# must be at  $V_L$ .  
The  $A_0$  value determines which WD/BC is supplied first:  $A_0 = 0$  looks at the WDL/BCL,  $A_0 = 1$  looks at the WDH/BCH.
4. BCH/WCH must be at 00H for this product because of the 256-byte (128-word) Page Buffer size and to avoid writing the Page Buffer contents into more than one 256-byte segment within an array block. They are simply shown for future Page Buffer expandability.
5. In x16 mode, only the lower byte  $DQ_{0-7}$  is used for WCL and WCH. The upper byte  $DQ_{8-15}$  is a don't care.
6. PBA and PD (whose count is given in cycles 2 and 3) are supplied starting in the fourth cycle, which is not shown.
7. This command allows the user to swap between available Page Buffers (0 or 1).
8. These commands reconfigure the RY/BY# output to one of two pulse-modes or enable and disable the RY/BY# function.
9. Program address, PA, is the destination address in the flash array which must match the source address in the Page Buffer. Refer to the *16-Mbit Flash Product Family User's Manual*.
10. BCL = 00H corresponds to a byte count of 1. Similarly, WCL = 00H corresponds to a word count of 1.
11. To ensure that the 28F016SA's power consumption during sleep mode reaches the deep power-down current level, the system also needs to de-select the chip by taking either or both  $CE_0\#$  or  $CE_1\#$  high.
12. The upper byte of the data bus ( $DQ_{8-15}$ ) during command writes is a "Don't Care" in x16 operation of the device.

#### 4.5 Compatible Status Register

WSMS	ESS	ES	DWS	VPPS	R	R	R
7	6	5	4	3	2	1	0

##### NOTES:

CSR.7 = WRITE STATE MACHINE STATUS  
 1 = Ready  
 0 = Busy

RY/BY# output or WSMS bit must be checked to determine completion of an operation (erase suspend, block erase or data program) before the appropriate Status bit (ESS, ES or DWS) is checked for success.

CSR.6 = ERASE-SUSPEND STATUS  
 1 = Erase Suspended  
 0 = Erase In Progress/Completed

CSR.5 = ERASE STATUS  
 1 = Error In Block Erasure  
 0 = Successful Block Erase

If DWS and ES are set to "1" during a block erase attempt, an improper command sequence was entered. Clear the CSR and attempt the operation again.

CSR.4 = DATA WRITE STATUS  
 1 = Error in Data Program  
 0 = Data Program Successful

CSR.3 = V<sub>PP</sub> STATUS  
 1 = V<sub>PP</sub> Low Detect, Operation Abort  
 0 = V<sub>PP</sub> OK

The VPPS bit, unlike an A/D converter, does not provide continuous indication of V<sub>PP</sub> level. The WSM interrogates V<sub>PP</sub>'s level only after the Data Program or Block Erase command sequences have been entered, and informs the system if V<sub>PP</sub> has not been switched on. VPPS is not guaranteed to report accurate feedback between V<sub>PPL</sub> and V<sub>PPH</sub>.

CSR.2-0 = RESERVED FOR FUTURE ENHANCEMENTS  
 These bits are reserved for future use; mask them out when polling the CSR.

#### 4.6 Global Status Register

WSMS	OSS	DOS	DSS	QS	PBAS	PBS	PBSS
7	6	5	4	3	2	1	0

<b>NOTES:</b>	
<p>GSR.7 = WRITE STATE MACHINE STATUS 1 = Ready 0 = Busy</p> <p>GSR.6 = OPERATION SUSPEND STATUS 1 = Operation Suspended 0 = Operation in Progress/Completed</p> <p>GSR.5 = DEVICE OPERATION STATUS 1 = Operation Unsuccessful 0 = Operation Successful or Currently Running</p> <p>GSR.4 = DEVICE SLEEP STATUS 1 = Device in Sleep 0 = Device Not in Sleep</p> <p>MATRIX <u>5/4</u> 0 0 = Operation Successful or Currently Running 0 1 = Device in Sleep Mode or Pending Sleep 1 0 = Operation Unsuccessful 1 1 = Operation Unsuccessful or Aborted</p> <p>GSR.3 = QUEUE STATUS 1 = Queue Full 0 = Queue Available</p> <p>GSR.2 = PAGE BUFFER AVAILABLE STATUS 1 = One or Two Page Buffers Available 0 = No Page Buffer Available</p> <p>GSR.1 = PAGE BUFFER STATUS 1 = Selected Page Buffer Ready 0 = Selected Page Buffer Busy</p> <p>GSR.0 = PAGE BUFFER SELECT STATUS 1 = Page Buffer 1 Selected 0 = Page Buffer 0 Selected</p>	<p>[1] RY/BY# output or WSMS bit must be checked to determine completion of an operation (block lock, erase suspend, any RY/BY# reconfiguration, Upload Status Bits, block erase or data program) before the appropriate Status bit (OSS or DOS) is checked for success.</p> <p>If operation currently running, then GSR.7 = 0.</p> <p>If device pending sleep, then GSR.7 = 0.</p> <p>Operation aborted: Unsuccessful due to Abort command.</p> <p>The device contains two Page Buffers.</p> <p>Selected Page Buffer is currently busy with WSM operation.</p>

**NOTE:**

- When multiple operations are queued, checking BSR.7 only provides indication of completion for that particular block. GSR.7 provides indication when all queued operations are completed.

#### 4.7 Block Status Register

BS	BLS	BOS	BOAS	QS	VPPS	R	R
7	6	5	4	3	2	1	0

NOTES:	
BSR.7 = BLOCK STATUS 1 = Ready 0 = Busy	[1] RY/BY# output or BS bit must be checked to determine completion of an operation (block lock, erase suspend, any RY/BY# reconfiguration, Upload Status Bits, block erase or data program) before the appropriate Status bits (BOS, BLS) is checked for success.
BSR.6 = BLOCK-LOCK STATUS 1 = Block Unlocked for Program/Erase 0 = Block Locked for Program/Erase	
BSR.5 = BLOCK OPERATION STATUS 1 = Operation Unsuccessful 0 = Operation Successful or Currently Running	The BOAS bit will not be set until BSR.7 = 1.
BSR.4 = BLOCK OPERATION ABORT STATUS 1 = Operation Aborted 0 = Operation Not Aborted	
MATRIX <u>5/4</u> 0 0 = Operation Successful or Currently Running 0 1 = Not a Valid Combination 1 0 = Operation Unsuccessful 1 1 = Operation Aborted	Operation halted via Abort command.
BSR.3 = QUEUE STATUS 1 = Queue Full 0 = Queue Available	
BSR.2 = V <sub>PP</sub> STATUS 1 = V <sub>PP</sub> Low Detect, Operation Abort 0 = V <sub>PP</sub> OK	
BSR.1–0 = RESERVED FOR FUTURE ENHANCEMENTS These bits are reserved for future use; mask them out when polling the BSRs.	

**NOTE:**

- When multiple operations are queued, checking BSR.7 only provides indication of completion for that particular block. BSR.7 provides indication when all queued operations are completed.

## 5.0 ELECTRICAL SPECIFICATIONS

### 5.1 Absolute Maximum Ratings\*

Temperature under Bias .....0°C to +80°C  
 Storage Temperature.....-65°C to +125°C

NOTICE: This is a production datasheet. The specifications are subject to change without notice. Verify with your local Intel Sales office that you have the latest datasheet before finalizing a design.

\* **WARNING:** *Stressing the device beyond the "Absolute Maximum Ratings" may cause permanent damage. These are stress ratings only. Operation beyond the "Operating Conditions" is not recommended and extended exposure beyond the "Operating Conditions" may effect device reliability.*

#### V<sub>CC</sub> = 3.3V ± 10% Systems

Sym	Parameter	Notes	Min	Max	Units	Test Conditions
T <sub>A</sub>	Operating Temperature, Commercial	1	0	70	°C	Ambient Temperature
V <sub>CC</sub>	V <sub>CC</sub> with Respect to GND	2	-0.2	7.0	V	
V <sub>PP</sub>	V <sub>PP</sub> Supply Voltage with Respect to GND	2,3	-0.2	14.0	V	
V	Voltage on Any Pin (Except V <sub>CC</sub> , V <sub>PP</sub> ) with Respect to GND	2	-0.5	V <sub>CC</sub> +0.5	V	
I	Current into Any Non-Supply Pin	5		± 30	mA	
I <sub>OUT</sub>	Output Short Circuit Current	4		100	mA	

#### V<sub>CC</sub> = 5.0V ± 10% , V<sub>CC</sub> = 5.0V ± 5% Systems<sup>(6)</sup>

Sym	Parameter	Notes	Min	Max	Units	Test Conditions
T <sub>A</sub>	Operating Temperature, Commercial	1	0	70	°C	Ambient Temperature
V <sub>CC</sub>	V <sub>CC</sub> with Respect to GND	2	-0.2	7.0	V	
V <sub>PP</sub>	V <sub>PP</sub> Supply Voltage with Respect to GND	2,3	-0.2	14.0	V	
V	Voltage on Any Pin (Except V <sub>CC</sub> , V <sub>PP</sub> ) with Respect to GND	2	-2.0	7.0	V	
I	Current into Any Non-Supply Pin	5		± 30	mA	
I <sub>OUT</sub>	Output Short Circuit Current	4		100	mA	

**NOTES:**

1. Operating temperature is for commercial product defined by this specification.
2. Minimum DC voltage is -10% on input/output pins. During transitions, this level may undershoot to -2.0V for periods <20 ns. Maximum DC voltage on input/output pins is V<sub>CC</sub> + 10% which, during transitions, may overshoot to V<sub>CC</sub> + 2.0V for periods <20 ns.
3. Maximum DC voltage on V<sub>PP</sub> may overshoot to +14.0V for periods <20 ns.
4. Output shorted for no more than one second. No more than one output shorted at a time.
5. This specification also applies to pins marked "NC."
6. 5% V<sub>CC</sub> specifications refer to the 28F016SA-070 in its High Speed Test configuration.



## 5.2 Capacitance

For a 3.3V System:

Symbol	Parameter	Notes	Typ	Max	Units	Test Conditions
C <sub>IN</sub>	Capacitance Looking into an Address/Control Pin	1	6	8	pF	T <sub>A</sub> = +25°C, f = 1.0 MHz
C <sub>OUT</sub>	Capacitance Looking into an Output Pin	1	8	12	pF	T <sub>A</sub> = +25°C, f = 1.0 MHz
C <sub>LOAD</sub>	Load Capacitance Driven by Outputs for Timing Specifications	1		50	pF	For V <sub>CC</sub> = 3.3V ± 10%
	Equivalent Testing Load Circuit			2.5	ns	50Ω Transmission Line Delay

For a 5.0V System:

Symbol	Parameter	Notes	Typ	Max	Units	Test Conditions
C <sub>IN</sub>	Capacitance Looking into an Address/Control Pin	1	6	8	pF	T <sub>A</sub> = +25°C, f = 1.0 MHz
C <sub>OUT</sub>	Capacitance Looking into an Output Pin	1	8	12	pF	T <sub>A</sub> = +25°C, f = 1.0 MHz
C <sub>LOAD</sub>	Load Capacitance Driven by Outputs for Timing Specifications	1		100	pF	For V <sub>CC</sub> = 5.0V ± 10%
				30	pF	For V <sub>CC</sub> = 5.0V ± 5%
	Equivalent Testing Load Circuit for V <sub>CC</sub> ± 10%			2.5	ns	25Ω Transmission Line Delay
	Equivalent Testing Load Circuit for V <sub>CC</sub> ± 5%			2.5	ns	83Ω Transmission Line Delay

**NOTE:**

1. Sampled, not 100% tested.

### 5.3 Timing Nomenclature

All 3.3V system timings are measured from where signals cross 1.5V.

For 5.0V systems use the standard JEDEC cross point definitions.

Each timing parameter consists of five characters. Some common examples are defined below:

- t<sub>CE</sub> t<sub>ELQV</sub> time(t) from CE# (E) going low (L) to the outputs (Q) becoming valid (V)
- t<sub>OE</sub> t<sub>GLQV</sub> time(t) from OE# (G) going low (L) to the outputs (Q) becoming valid (V)
- t<sub>ACC</sub> t<sub>AVQV</sub> time(t) from address (A) valid (V) to the outputs (Q) becoming valid (V)
- t<sub>AS</sub> t<sub>AVWH</sub> time(t) from address (A) valid (V) to WE# (W) going high (H)
- t<sub>DH</sub> t<sub>WHDx</sub> time(t) from WE# (W) going high (H) to when the data (D) can become undefined (X)

	Pin Characters		Pin States
A	Address Inputs	H	High
D	Data Inputs	L	Low
Q	Data Outputs	V	Valid
E	CE# (Chip Enable)	X	Driven, but not necessarily valid
F	BYTE# (Byte Enable)	Z	High Impedance
G	OE# (Output Enable)		
W	WE# (Write Enable)		
P	RP# (Deep Power-Down Pin)		
R	RY/BY# (Ready Busy)		
V	Any Voltage Level		
Y	3/5# Pin		
5V	V <sub>CC</sub> at 4.5V Minimum		
3V	V <sub>CC</sub> at 3.0V Minimum		

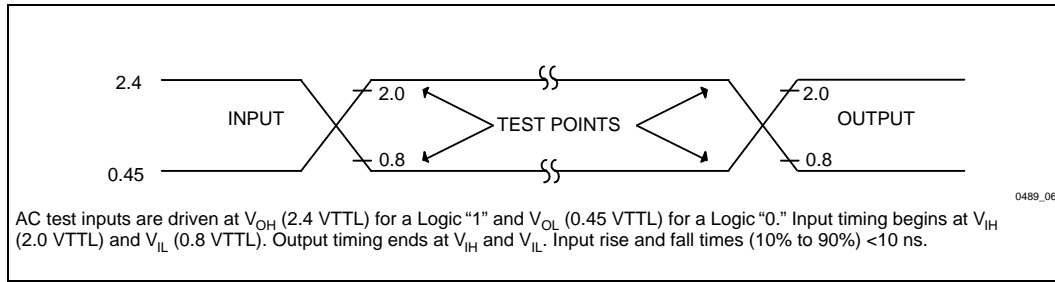

**Figure 7. Transient Input/Output Reference Waveform ( $V_{CC} = 5.0V \pm 10\%$ ) for Standard Test Configuration(1)**

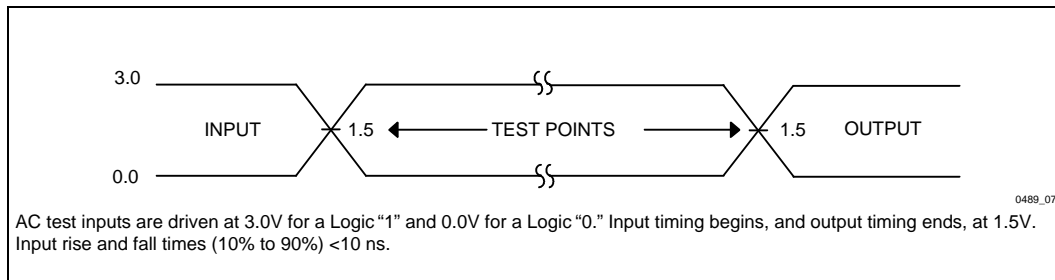

**Figure 8. Transient Input/Output Reference Waveform ( $V_{CC} = 3.3V \pm 10\%$ ) High Speed Reference Waveform(2) ( $V_{CC} = 5.0V \pm 5\%$ )**

**NOTES:**

1. Testing characteristics for 28F016SA-080/28F016SA-100.
2. Testing characteristics for 28F016SA-070/28F016SA-120/28F016SA-150.





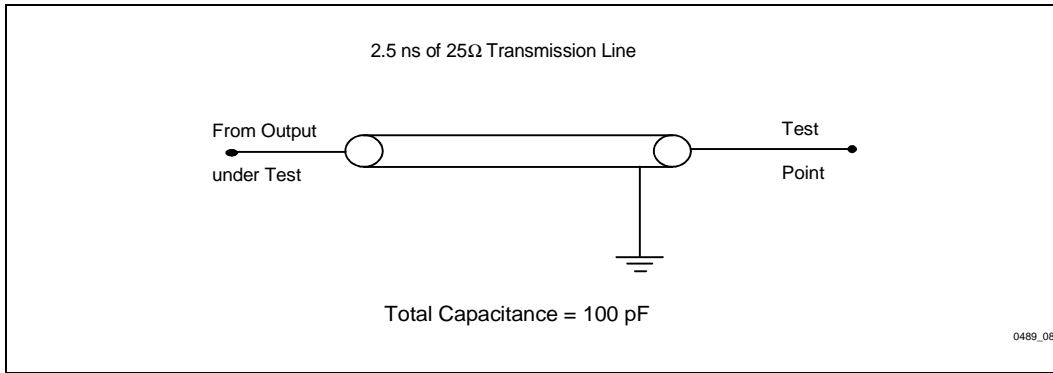

Figure 9. Transient Equivalent Testing Load Circuit ( $V_{CC} = 5.0V \pm 10\%$ )

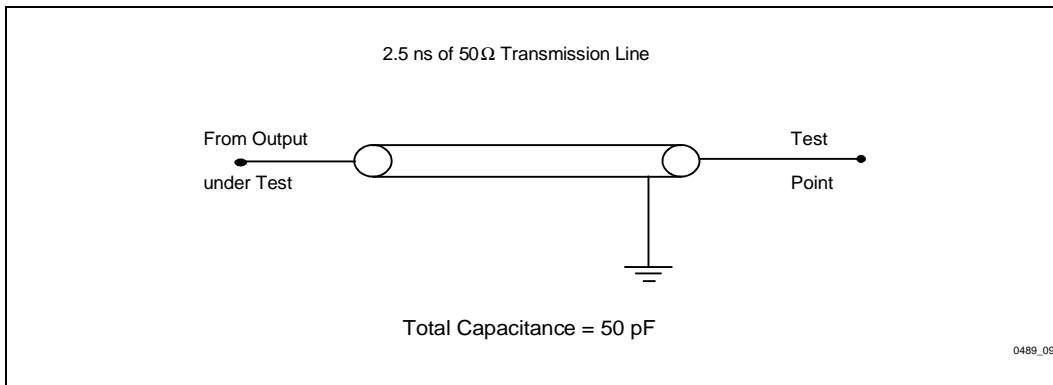

Figure 10. Transient Equivalent Testing Load Circuit ( $V_{CC} = 3.3V \pm 10\%$ )

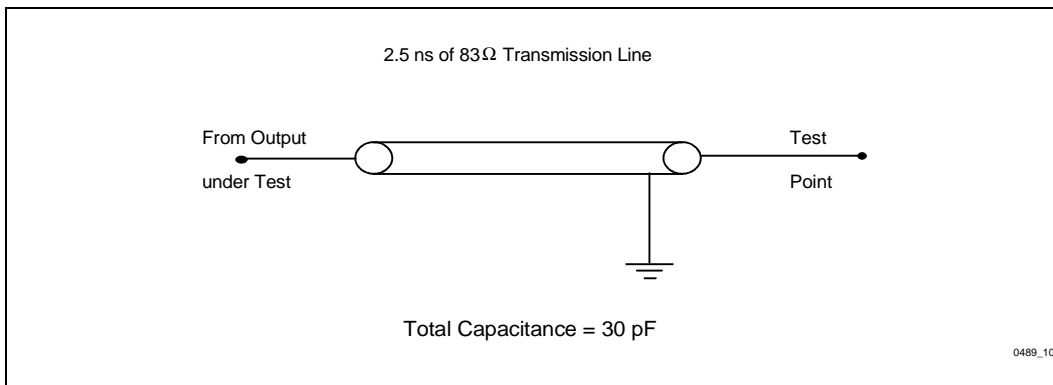

Figure 11. High Speed Transient Equivalent Testing Load Circuit ( $V_{CC} = 5.0V \pm 5\%$ )



## 5.4 DC Characteristics: COMMERCIAL AND EXTENDED TEMPERATURE

$V_{CC} = 3.3V \pm 10\%$ ,  $T_A = 0^\circ C$  to  $+70^\circ C$ ,  $-40^\circ C$  to  $+85^\circ C$   
 3/5# = Pin Set High for 3.3V Operations

Sym	Parameter	Temp	Comm		Extended		Units	Test Conditions
		Notes	Typ	Max	Typ	Max		
$I_{IL}$	Input Load Current	1		$\pm 1$		$\pm 1$	$\mu A$	$V_{CC} = V_{CC} \text{ Max}$ $V_{IN} = V_{CC} \text{ or GND}$
$I_{LO}$	Output Leakage Current	1		$\pm 10$		$\pm 10$	$\mu A$	$V_{CC} = V_{CC} \text{ Max}$ $V_{IN} = V_{CC} \text{ or GND}$
$I_{CCS}$	$V_{CC}$ Standby Current	1,5,6	50	100	70	250	$\mu A$	$V_{CC} = V_{CC} \text{ Max}$ $CE_0\#, CE_1\#, RP\#, = V_{CC} \pm 0.2V$ $BYTE\#, WP\#, 3/5\# = V_{CC} \pm 0.2V \text{ or GND} \pm 0.2V$
			1	4	1	10	mA	$V_{CC} = V_{CC} \text{ Max}$ $CE_0\#, CE_1\#, RP\# = V_{IH}$ $BYTE\#, WP\#, 3/5\# = V_{IH} \text{ or } V_{IL}$
$I_{CCD}$	$V_{CC}$ Deep Power-Down Current	1	1	5	3	35	$\mu A$	$RP\# = GND \pm 0.2V$ $BYTE\# = GND \pm 0.2V \text{ or } V_{CC} \pm 0.2V$
$I_{CCR1}$	$V_{CC}$ Read Current	1,4,5	30	35	30	40	mA	$V_{CC} = V_{CC} \text{ Max}$ CMOS: $CE_0\#, CE_1\# = GND \pm 0.2V$ , $BYTE\# = GND \pm 0.2V \text{ or } V_{CC} \pm 0.2V$ , Inputs = $GND \pm 0.2V \text{ or } V_{CC} \pm 0.2V$ TTL: $CE_0\#, CE_1\# = V_{IL}$ , $BYTE\# = V_{IL} \text{ or } V_{IH}$ , Inputs = $V_{IL} \text{ or } V_{IH}$ $f = 8 \text{ MHz}$ , $I_{OUT} = 0 \text{ mA}$
$I_{CCR2}$	$V_{CC}$ Read Current	1,4,5	15	20	15	25	mA	$V_{CC} = V_{CC} \text{ Max}$ CMOS: $CE_0\#, CE_1\# = GND \pm 0.2V$ , $BYTE\# = GND \pm 0.2V \text{ or } V_{CC} \pm 0.2V$ , Inputs = $GND \pm 0.2V \text{ or } V_{CC} \pm 0.2V$ TTL: $CE_0\#, CE_1\# = V_{IL}$ , $BYTE\# = V_{IL} \text{ or } V_{IH}$ , Inputs = $V_{IL} \text{ or } V_{IH}$ $f = 4 \text{ MHz}$ , $I_{OUT} = 0 \text{ mA}$
$I_{CCW}$	$V_{CC}$ Program Current for Word or Byte	1	8	12	8	12	mA	Program in Progress
$I_{CCE}$	$V_{CC}$ Block Erase Current	1	6	12	6	12	mA	Block Erase in Progress
$I_{CCES}$	$V_{CC}$ Erase Suspend Current	1,2	3	6	3	6	mA	$CE_0\#, CE_1\# = V_{IH}$ Block Erase Suspended

#### 5.4 DC Characteristics: COMMERCIAL AND EXTENDED TEMPERATURE

(Continued)

$V_{CC} = 3.3V \pm 10\%$ ,  $T_A = 0^\circ C$  to  $+70^\circ C$ ,  $-40^\circ C$  to  $+85^\circ C$   
 3/5# = Pin Set High for 3.3V Operations

Sym	Parameter	Temp	Comm		Extended		Units	Test Conditions
		Notes	Typ	Max	Typ	Max		
$I_{PPS}$	$V_{PP}$ Standby/	1	$\pm 1$	$\pm 10$	$\pm 1$	$\pm 10$	$\mu A$	$V_{PP} \leq V_{CC}$
$I_{PPR}$	Read Current		65	200	65	200	$\mu A$	$V_{PP} > V_{CC}$
$I_{PPD}$	$V_{PP}$ Deep Power-Down Current	1	0.2	5	0.2	5	$\mu A$	RP# = GND $\pm 0.2V$

## 5.4 DC Characteristics: COMMERCIAL AND EXTENDED TEMPERATURE

(Continued)

 $V_{CC} = 3.3V \pm 10\%$ ,  $T_A = 0^\circ C$  to  $+70^\circ C$ ,  $-40^\circ C$  to  $+85^\circ C$ 

3/5# = Pin Set High for 3.3V Operations

Sym	Parameter	Temp	Comm/Extended			Units	Test Conditions
		Notes	Min	Typ	Max		
I <sub>PPW</sub>	V <sub>PP</sub> Program Current for Word or Byte	1		10	15	mA	V <sub>PP</sub> = V <sub>PPH</sub> Program in Progress
I <sub>PPE</sub>	V <sub>PP</sub> Block Erase Current	1		4	10	mA	V <sub>PP</sub> = V <sub>PPH</sub> Block Erase in Progress
I <sub>PPES</sub>	V <sub>PP</sub> Erase Suspend Current	1		65	200	μA	V <sub>PP</sub> = V <sub>PPH</sub> Block Erase Suspended
V <sub>IL</sub>	Input Low Voltage		-0.3		0.8	V	
V <sub>IH</sub>	Input High Voltage		2.0		V <sub>CC</sub> + 0.3	V	
V <sub>OL</sub>	Output Low Voltage				0.4	V	V <sub>CC</sub> = V <sub>CC</sub> Min I <sub>OL</sub> = 4 mA
V <sub>OH1</sub>	Output High Voltage		2.4			V	V <sub>CC</sub> = V <sub>CC</sub> Min I <sub>OH</sub> = -2.0 mA
V <sub>OH2</sub>			V <sub>CC</sub> - 0.2			V	V <sub>CC</sub> = V <sub>CC</sub> Min I <sub>OH</sub> = -100 μA
V <sub>PPL</sub>	V <sub>PP</sub> during Normal Operations	3	0.0		6.5	V	
V <sub>PPH</sub>	V <sub>PP</sub> during Program/Erase Operations	3	11.4	12.0	12.6	V	
V <sub>LKO</sub>	V <sub>CC</sub> Program/Erase Lock Voltage		2.0			V	

**NOTES:**

- All currents are in RMS unless otherwise noted. Typical values at  $V_{CC} = 3.3V$ ,  $V_{PP} = 12.0V$ ,  $T = 25^\circ C$ . These currents are valid for all product versions (package and speeds).
- I<sub>CCES</sub> is specified with the device deselected. If the device is read while in erasesuspend mode, current draw is the sum of I<sub>CCES</sub> and I<sub>CCR</sub>.
- Block erases, word/byte programs and lock block operations are inhibited when  $V_{PP} = V_{PPL}$  and not guaranteed in the range between V<sub>PPH</sub> and V<sub>PPL</sub>.
- Automatic Power Savings (APS) reduces I<sub>CCR</sub> to less than 1 mA in static operation.
- CMOS Inputs are either  $V_{CC} \pm 0.2V$  or  $GND \pm 0.2V$ . TTL Inputs are either V<sub>IL</sub> or V<sub>IH</sub>.
- Standby current levels are not reached when putting the chip in standby mode immediately after reading the page buffer. Default the device into read array or read Status Register mode before entering standby to ensure standby current levels.

**5.5 DC Characteristics: COMMERCIAL AND EXTENDED TEMPERATURE**

$V_{CC} = 5.0V \pm 10\%$ ,  $5.0V \pm 5\%$ ,  $T_A = 0^\circ C$  to  $+70^\circ C$ ,  $-40^\circ C$  to  $+85^\circ C$   
 3/5# Pin Set Low for 5V Operations

Sym	Parameter	Temp	Comm		Extended		Units	Test Conditions
		Notes	Typ	Max	Typ	Max		
I <sub>IL</sub>	Input Load Current	1		± 1		± 1	μA	V <sub>CC</sub> = V <sub>CC</sub> Max V <sub>IN</sub> = V <sub>CC</sub> or GND
I <sub>LO</sub>	Output Leakage Current	1		± 10		± 10	μA	V <sub>CC</sub> = V <sub>CC</sub> Max V <sub>IN</sub> = V <sub>CC</sub> or GND
I <sub>CCS</sub>	V <sub>CC</sub> Standby Current	1,5,6	50	100	70	250	μA	V <sub>CC</sub> = V <sub>CC</sub> Max CE <sub>0</sub> #, CE <sub>1</sub> #, RP# = V <sub>CC</sub> ± 0.2V BYTE#, WP#, 3/5# = V <sub>CC</sub> ± 0.2V or GND ± 0.2V
			2	4	2	10	mA	V <sub>CC</sub> = V <sub>CC</sub> Max CE <sub>0</sub> #, CE <sub>1</sub> #, RP# = V <sub>IH</sub> BYTE#, WP#, 3/5# = V <sub>IH</sub> or V <sub>IL</sub>
I <sub>CCD</sub>	V <sub>CC</sub> Deep Power-Down Current	1	1	5	10	60	μA	RP# = GND ± 0.2V BYTE# = GND ± 0.2V or V <sub>CC</sub> ± 0.2V
I <sub>CCR1</sub>	V <sub>CC</sub> Read Current	1,4,5	50	60	55	70	mA	V <sub>CC</sub> = V <sub>CC</sub> Max CMOS: CE <sub>0</sub> #, CE <sub>1</sub> # = GND ± 0.2V, BYTE# = GND ± 0.2V or V <sub>CC</sub> ± 0.2V, Inputs = GND ± 0.2V or V <sub>CC</sub> ± 0.2V TTL: CE <sub>0</sub> #, CE <sub>1</sub> # = V <sub>IL</sub> , BYTE# = V <sub>IL</sub> or V <sub>IH</sub> , Inputs = V <sub>IL</sub> or V <sub>IH</sub> f = 10 MHz, I <sub>OUT</sub> = 0 mA
I <sub>CCR2</sub>	V <sub>CC</sub> Read Current	1,4,5	30	35	30	35	mA	V <sub>CC</sub> = V <sub>CC</sub> Max CMOS: CE <sub>0</sub> #, CE <sub>1</sub> # = GND ± 0.2V, BYTE# = GND ± 0.2V or V <sub>CC</sub> ± 0.2V, Inputs = GND ± 0.2V or V <sub>CC</sub> ± 0.2V TTL: CE <sub>0</sub> #, CE <sub>1</sub> # = V <sub>IL</sub> , BYTE# = V <sub>IL</sub> or V <sub>IH</sub> , Inputs = V <sub>IL</sub> or V <sub>IH</sub> f = 5 MHz, I <sub>OUT</sub> = 0 mA
I <sub>CCW</sub>	V <sub>CC</sub> Program Current for Word or Byte	1	25	35	25	35	mA	Program in Progress
I <sub>CCB</sub>	V <sub>CC</sub> Block Erase Current	1	18	25	18	25	mA	Block Erase in Progress
I <sub>CCES</sub>	V <sub>CC</sub> Erase Suspend Current	1,2	5	10	5	10	mA	CE <sub>0</sub> #, CE <sub>1</sub> # = V <sub>IH</sub> Block Erase Suspended

## 5.5 DC Characteristics: COMMERCIAL AND EXTENDED TEMPERATURE

(Continued)

$V_{CC} = 5.0V \pm 10\%$ ,  $5.0V \pm 5\%$ ,  $T_A = 0^\circ C$  to  $+70^\circ C$ ,  $-40^\circ C$  to  $+85^\circ C$   
 3/5# Pin Set Low for 5V Operations

Sym	Parameter	Temp	Comm		Extended		Units	Test Conditions
		Notes	Typ	Max	Typ	Max		
$I_{PPS}$	$V_{PP}$ Standby/Read Current	1	$\pm 1$	$\pm 10$	$\pm 1$	$\pm 10$	$\mu A$	$V_{PP} \leq V_{CC}$
$I_{PPR}$			65	200	65	200	$\mu A$	$V_{PP} > V_{CC}$
$I_{PPD}$	$V_{PP}$ Deep Power-Down Current	1	0.2	5	0.2	5	$\mu A$	$RP\# = GND \pm 0.2V$

## 5.5 DC Characteristics: COMMERCIAL AND EXTENDED TEMPERATURE

(Continued)

$V_{CC} = 5.0V \pm 10\%$ ,  $5.0V \pm 5\%$ ,  $T_A = 0^\circ\text{C}$  to  $+70^\circ\text{C}$ ,  $-40^\circ\text{C}$  to  $+85^\circ\text{C}$   
 3/5# Pin Set Low for 5V Operations

Sym	Parameter	Temp	Comm/Extended			Units	Test Conditions
		Notes	Min	Typ	Max		
I <sub>PPW</sub>	V <sub>PP</sub> Program Current for Word or Byte	1		7	12	mA	V <sub>PP</sub> = V <sub>PPH</sub> Program in Progress
I <sub>PPE</sub>	V <sub>PP</sub> Block Erase Current	1		5	10	mA	V <sub>PP</sub> = V <sub>PPH</sub> Block Erase in Progress
I <sub>PPES</sub>	V <sub>PP</sub> Erase Suspend Current	1		65	200	μA	V <sub>PP</sub> = V <sub>PPH</sub> Block Erase Suspended
V <sub>IL</sub>	Input Low Voltage		-0.5		0.8	V	
V <sub>IH</sub>	Input High Voltage		2.0		V <sub>CC</sub> +0.5	V	
V <sub>OL</sub>	Output Low Voltage				0.45	V	V <sub>CC</sub> = V <sub>CC</sub> Min I <sub>OL</sub> = 5.8 mA
V <sub>OH1</sub>	Output High Voltage		0.85 V <sub>CC</sub>			V	V <sub>CC</sub> = V <sub>CC</sub> Min I <sub>OH</sub> = -2.5 mA
V <sub>OH2</sub>			V <sub>CC</sub> -0.4			V	V <sub>CC</sub> = V <sub>CC</sub> Min I <sub>OH</sub> = -100 μA
V <sub>PPL</sub>	V <sub>PP</sub> during Normal Operations	3	0.0		6.5	V	
V <sub>PPH</sub>	V <sub>PP</sub> during Program/Erase Operations		11.4	12.0	12.6	V	
V <sub>LKO</sub>	V <sub>CC</sub> Program/Erase Lock Voltage		2.0			V	

### NOTES:

- All currents are in RMS unless otherwise noted. Typical values at V<sub>CC</sub> = 5.0V, V<sub>PP</sub> = 12.0V, T = 25°C. These currents are valid for all product versions (package and speeds).
- I<sub>CCES</sub> is specified with the device deselected. If the device is read while in erasesuspend mode, current draw is the sum of I<sub>CCES</sub> and I<sub>CCR</sub>.
- Block erases, word/byte programs and lock block operations are inhibited when V<sub>PP</sub> = V<sub>PPL</sub> and not guaranteed in the range between V<sub>PPH</sub> and V<sub>PPL</sub>.
- Automatic Power Saving (APS) reduces I<sub>CCR</sub> to less than 2 mA in static operation.
- CMOS Inputs are either V<sub>CC</sub> ± 0.2V or GND ± 0.2V. TTL Inputs are either V<sub>IL</sub> or V<sub>IH</sub>.
- Standby current levels are not reached when putting the chip in standby mode immediately after reading the page buffer. Default the device into read array or read Status Register mode before entering standby to ensure standby current levels.

## 5.6 AC Characteristics—Read Only Operations: COMMERCIAL AND EXTENDED TEMPERATURE(1)

$V_{CC} = 3.3V \pm 10\%$ ,  $T_A = 0^\circ C$  to  $+70^\circ C$ ,  $-40^\circ C$  to  $+85^\circ C$

Sym	Parameter	Temp	Commercial				Extended		Units
		Speed	-120		-150		-150		
		V <sub>CC</sub>	3.3V ± 10%						
		Load	50 pF						
		Notes	Min	Max	Min	Max	Min	Max	
t <sub>AVAV</sub>	Read Cycle Time		120		150		150		ns
t <sub>AVQV</sub>	Address to Output Delay			120		150		150	ns
t <sub>ELQV</sub>	CE# to Output Delay	2		120		150		150	ns
t <sub>PHQV</sub>	RP# High to Output Delay			620		750		750	ns
t <sub>GLQV</sub>	OE# to Output Delay	2		45		50		50	ns
t <sub>ELQX</sub>	CE# to Output in Low Z	3	0		0		0		ns
t <sub>EHQZ</sub>	CE# to Output in High Z	3		30		35		35	ns
t <sub>GLQX</sub>	OE# to Output in Low Z	3	0		0		0		ns
t <sub>GHQZ</sub>	OE# to Output in High Z	3		15		20		20	ns
t <sub>OH</sub>	Output Hold from Address, CE# or OE# Change, Whichever Occurs First	3	0		0		0		ns
t <sub>FLQV</sub> t <sub>FHQV</sub>	BYTE# to Output Delay	3		120		150		150	ns
t <sub>FLQZ</sub>	BYTE# Low to Output in High Z	3		30		40		40	ns
t <sub>ELFL</sub> t <sub>ELFH</sub>	CE# Low to BYTE# High or Low	3		5		5		5	ns

### For Extended Status Register Reads

Symbol	Parameter	Temp	Commercial		Extended		Units
		Speed	-120		-150		
		V <sub>CC</sub>	3.3V ± 10%				
		Load	50 pF				
		Notes	Min	Max	Min	Max	
t <sub>AVEL</sub>	Address Setup to CE# Going Low	3,4	0		0		ns
t <sub>AVGL</sub>	Address Setup to OE# Going Low	3,4	0		0		ns



### 5.6 AC Characteristics—Read Only Operations: COMMERCIAL AND EXTENDED TEMPERATURE(1) (Continued)

$V_{CC} = 5.0V \pm 10\%$ ,  $5.0V \pm 5\%$ ,  $T_A = 0^\circ C$  to  $+70^\circ C$ .  $-40^\circ C$  to  $+85^\circ C$

Sym	Parameter	Temp	Commercial				Comm/Ext		Units
		Speed	-70		-80		-100		
		V <sub>CC</sub>	5.0V ± 5%V		5.0V ± 10%V		5.0V ± 10%V		
		Load	30 pF		50 pF		50%		
		Notes	Min	Max	Min	Max	Min	Max	
t <sub>AVAV</sub>	Read Cycle Time		70		80		100		ns
t <sub>AVQV</sub>	Address to Output Delay			70		80		100	ns
t <sub>ELQV</sub>	CE# to Output Delay	2		70		80		100	ns
t <sub>PHQV</sub>	RP# to Output Delay			400		480		550	ns
t <sub>GLQV</sub>	OE# to Output Delay	2		30		35		40	ns
t <sub>ELQX</sub>	CE# to Output in Low Z	3	0		0		0		ns
t <sub>EHQZ</sub>	CE# to Output in High Z	3		25		30		30	ns
t <sub>GLQX</sub>	OE# to Output in Low Z	3	0		0		0		ns
t <sub>GHQZ</sub>	OE# to Output in High Z	3		15		15		15	ns
t <sub>OH</sub>	Output Hold from Address, CE# or OE# Change, Whichever Occurs First	3	0		0		0		ns
t <sub>FLQV</sub> t <sub>FHQV</sub>	BYTE# to Output Delay	3		70		80		100	ns
t <sub>FLQZ</sub>	BYTE# Low to Output in High Z	3		25		30		30	ns
t <sub>ELFL</sub> t <sub>ELFH</sub>	CE# Low to BYTE# High or Low	3		5		5		5	ns

## For Extended Status Register Reads

Versions <sup>(5)</sup>		Temp	Commercial		Commercial		Comm/Ext		Units
		Load	30 pF		50 pF		50 pF		
		V <sub>CC</sub> ± 5%	28F016SA-070 <sup>(6)</sup>						
		V <sub>CC</sub> ± 10%			28F016SA-080 <sup>(7)</sup>		28F016SA-100 <sup>(7)</sup>		
Sym	Parameter	Notes	Min	Max	Min	Max	Min	Max	
t <sub>AVEL</sub>	Address Setup to CE# Going Low	3,4	0		0		0		ns
t <sub>AVGL</sub>	Address Setup to OE# Going Low	3,4	0		0		0		ns

## NOTES:

1. See AC Input/Output Reference Waveforms for timing measurements, Figures 7 and 8.
2. OE# may be delayed up to t<sub>ELQV</sub>–t<sub>GLQV</sub> after the falling edge of CE# without impact on t<sub>ELQV</sub>.
3. Sampled, not 100% tested.
4. This timing parameter is used to latch the correct BSR data onto the outputs.
5. Device speeds are defined as:
  - 70/80 ns at V<sub>CC</sub> = 5.0V equivalent to
  - 120 ns at V<sub>CC</sub> = 3.3V
  - 100 ns at V<sub>CC</sub> = 5.0V equivalent to
  - 150 ns at V<sub>CC</sub> = 3.3V
6. See AC Input/Output Reference Waveforms and AC Testing Load Circuits for High Speed Test Configuration.
7. See Standard AC Input/Output Reference Waveforms and AC Testing Load Circuit.

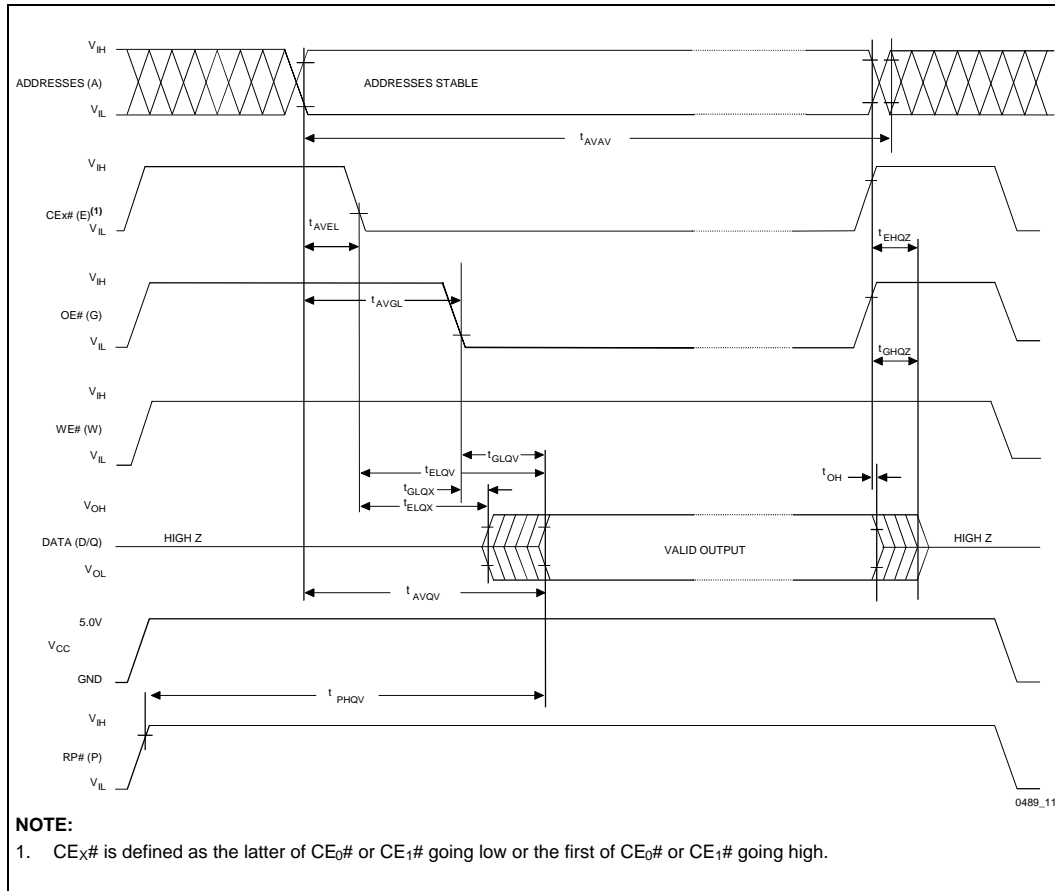

Figure 12. Read Timing Waveforms



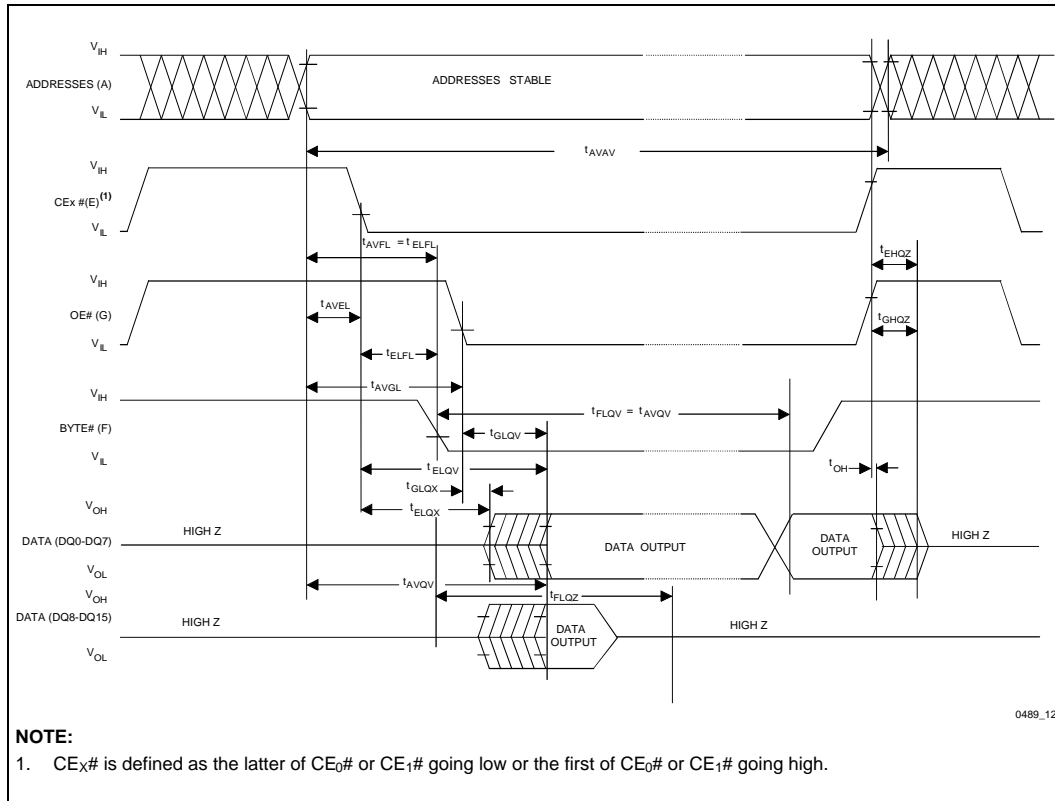
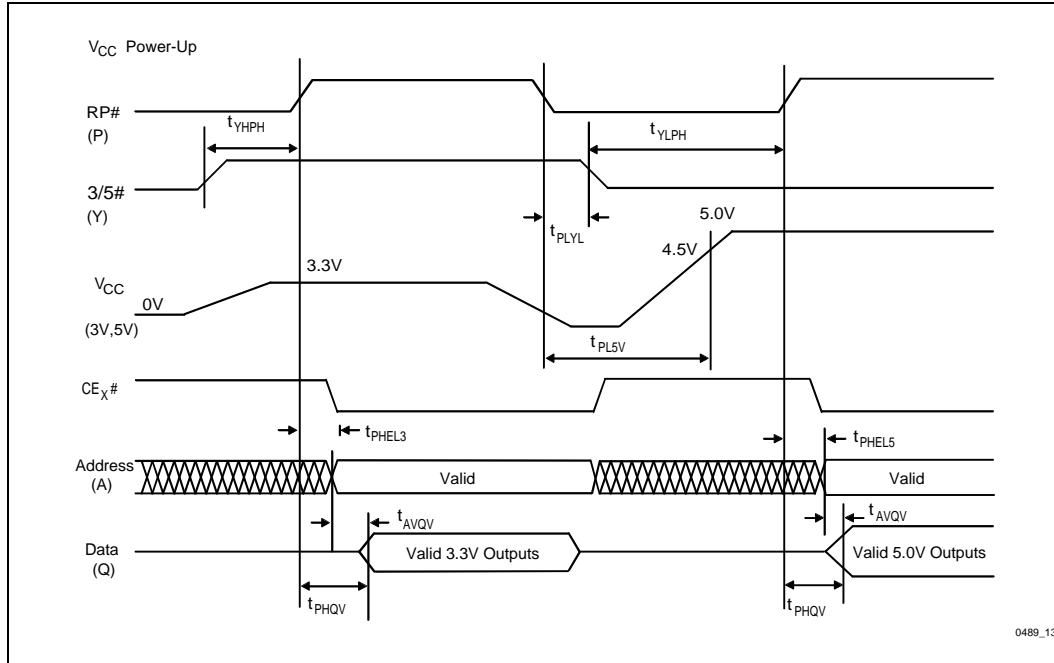

Figure 13. BYTE# Timing Waveforms



**5.7 Power-Up and Reset Timings: COMMERCIAL/EXTENDED TEMPERATURE**

**Figure 14. V<sub>CC</sub> Power-Up and RP# Reset Waveforms**

Symbol	Parameter	Notes	Min	Max	Unit
t <sub>PLYL</sub> t <sub>PLYH</sub>	RP# Low to 3/5# Low (High)		0		μs
t <sub>YLPH</sub> t <sub>YHPH</sub>	3/5# Low (High) to RP# High	1	2		μs
t <sub>PL5V</sub> t <sub>PL3V</sub>	RP# Low to V <sub>CC</sub> at 4.5V minimum (to V <sub>CC</sub> at 3.0V min or 3.6V max)	2	0		μs
t <sub>PHL3</sub>	RP# High to CE# Low (3.3V V <sub>CC</sub> )	1	500		ns
t <sub>PHL5</sub>	RP# High to CE# Low (5V V <sub>CC</sub> )	1	330		ns
t <sub>AVQV</sub>	Address Valid to Data Valid for V <sub>CC</sub> = 5V ± 10%	3		80	ns
t <sub>PHQV</sub>	RP# High to Data Valid for V <sub>CC</sub> = 5V ± 10%	3		480	ns

**NOTES:**

CE<sub>0</sub>#, CE<sub>1</sub># and OE# are switched low after Power-Up.

1. The t<sub>YLPH</sub>/t<sub>YHPH</sub> and t<sub>PHL3</sub>/t<sub>PHL5</sub> times must be strictly followed to guarantee all other read and program specifications.
2. The power supply may start to switch concurrently with RP# going low.
3. The address access time and RP# high to data valid time are shown for 5V V<sub>CC</sub> operation of the 28F016SA-080. Refer to the AC Characteristics Read Only Operations for 3.3V V<sub>CC</sub> and all other speed options.

### 5.8 AC Characteristics for WE#-Controlled Command Write Operations: COMMERCIAL AND EXTENDED TEMPERATURE(1)

$V_{CC} = 3.3V \pm 10\%$ ,  $T_A = 0^\circ C$  to  $+70^\circ C$ ,  $-40^\circ C$  to  $+85^\circ C$

Sym	Parameter	Temp	Commercial			Comm/Extended			Units
		Notes	Min	Typ	Max	Min	Typ	Max	
t <sub>AVAV</sub>	Write Cycle Time		120			150			ns
t <sub>VPWH</sub>	V <sub>PP</sub> Setup to WE# Going High	3	100			100			ns
t <sub>PHEL</sub>	RP# Setup to CE# Going Low		480			480			ns
t <sub>ELWL</sub>	CE# Setup to WE# Going Low		10			10			ns
t <sub>AVWH</sub>	Address Setup to WE# Going High	2,6	75			75			ns
t <sub>DVWH</sub>	Data Setup to WE# Going High	2,6	75			75			ns
t <sub>WLWH</sub>	WE# Pulse Width		75			75			ns
t <sub>WHDX</sub>	Data Hold from WE# High	2	10			10			ns
t <sub>WHAX</sub>	Address Hold from WE# High	2	10			10			ns
t <sub>WHEH</sub>	CE# Hold from WE# High		10			10			ns
t <sub>WHWL</sub>	WE# Pulse Width High		45			75			ns
t <sub>GHWL</sub>	Read Recovery before Write		0			0			ns
t <sub>WHRL</sub>	WE# High to RY/BY# Going Low				100			100	ns
t <sub>RHPL</sub>	RP# Hold from Valid Status Register (CSR, GSR, BSR) Data and RY/BY# High	3	0			0			ns
t <sub>PHWL</sub>	RP# High Recovery to WE# Going Low		1			1			μs
t <sub>WHGL</sub>	Write Recovery before Read		95			120			ns
t <sub>QVVL</sub>	V <sub>PP</sub> Hold from Valid Status Register (CSR, GSR, BSR) Data and RY/BY# High		0			0			μs
t <sub>WHQV1</sub>	Duration of Word/Byte Program Operation	4,5	5	9	Note 7	5	9	Note 7	μs
t <sub>WHQV2</sub>	Duration of Block Erase Operation	4	0.3		10	0.3		10	sec

**5.8 AC Characteristics for WE#-Controlled Command Write Operations:  
COMMERCIAL AND EXTENDED TEMPERATURE<sup>(1)</sup>** (Continued)

 $V_{CC} = 5.0V \pm 10\%$ ,  $5.0V \pm 5\%$ ,  $T_A = 0^\circ C$  to  $+70^\circ C$ ,  $-40^\circ C$  to  $+85^\circ C$ 

Versions		Temp	Commercial			Commercial			Comm/Ext			Unit
		$V_{CC} \pm 5\%$	28F016SA-070									
		$V_{CC} \pm 10\%$				28F016SA-080			28F016SA-100			
Sym	Parameter	Notes	Min	Typ	Max	Min	Typ	Max	Min	Typ	Max	
$t_{AVAV}$	Write Cycle Time		70			80			100			ns
$t_{VPWH}$	$V_{PP}$ Setup to WE# Going High	3	100			100			100			ns
$t_{PHEL}$	RP# Setup to CE# Going Low		480			480			480			ns
$t_{ELWL}$	CE# Setup to WE# Going Low		0			0			0			ns
$t_{AVWH}$	Address Setup to WE# Going High	2,6	50			50			50			ns
$t_{DVWH}$	Data Setup to WE# Going High	2,6	50			50			50			ns
$t_{WLWH}$	WE# Pulse Width		40			50			50			ns
$t_{WHDX}$	Data Hold from WE# High	2	0			0			0			ns
$t_{WHAX}$	Address Hold from WE# High	2	10			10			10			ns
$t_{WHEH}$	CE# Hold from WE# High		10			10			10			ns
$t_{WHWL}$	WE# Pulse Width High		30			30			50			ns
$t_{GHWL}$	Read Recovery before Write		0			0			0			ns

### 5.8 AC Characteristics for WE#-Controlled Command Write Operations: COMMERCIAL AND EXTENDED TEMPERATURE<sup>(1)</sup> (Continued)

V<sub>CC</sub> = 5.0V ±10%, 5.0V ± 5%, T<sub>A</sub> = 0°C to +70°C, -40°C to +85°C

Versions		Temp	Commercial			Commercial			Comm/Ext			Unit
		V <sub>CC</sub> ± 5%	28F016SA-070									
		V <sub>CC</sub> ± 10%				28F016SA-080			28F016SA-100			
Sym	Parameter	Notes	Min	Typ	Max	Min	Typ	Max	Min	Typ	Max	
t <sub>WHRL</sub>	WE# High to RY/BY# Going Low				100			100			100	ns
t <sub>RHPL</sub>	RP# Hold from Valid Status Register (CSR, GSR, BSR) Data and RY/BY# High	3	0			0			0			ns
t <sub>PHWL</sub>	RP# High Recovery to WE# Going Low		1			1			1			μs
t <sub>WHGL</sub>	Write Recovery before Read		60			65			80			ns
t <sub>QVVL</sub>	V <sub>PP</sub> Hold from Valid Status Register (CSR, GSR, BSR) Data and RY/BY# High		0			0			0			μs
t <sub>WHQV1</sub>	Duration of Word/Byte Program Operation	4,5	4.5	6	Note 7	4.5	6	Note 7	4.5	6	Note 7	μs
t <sub>WHQV2</sub>	Duration of Block Erase Operation	4	0.3		10	0.3		10	0.3		10	sec



**NOTES:**

CE# is defined as the latter of CE<sub>0</sub># or CE<sub>1</sub># going low or the first of CE<sub>0</sub># or CE<sub>1</sub># going high.

1. Read timings during data program and block erase are the same as for normal read.
2. Refer to command definition tables for valid address and data values.
3. Sampled, but not 100% tested.
4. Data program/block erase durations are measured to valid Status Register data.
5. Word/byte program operations are typically performed with 1 programming pulse.
6. Address and data are latched on the rising edge of WE# for all command write operations.
7. This information will be available in a technical paper. Please call Intel's Application Hotline or your local Intel sales office for more information.

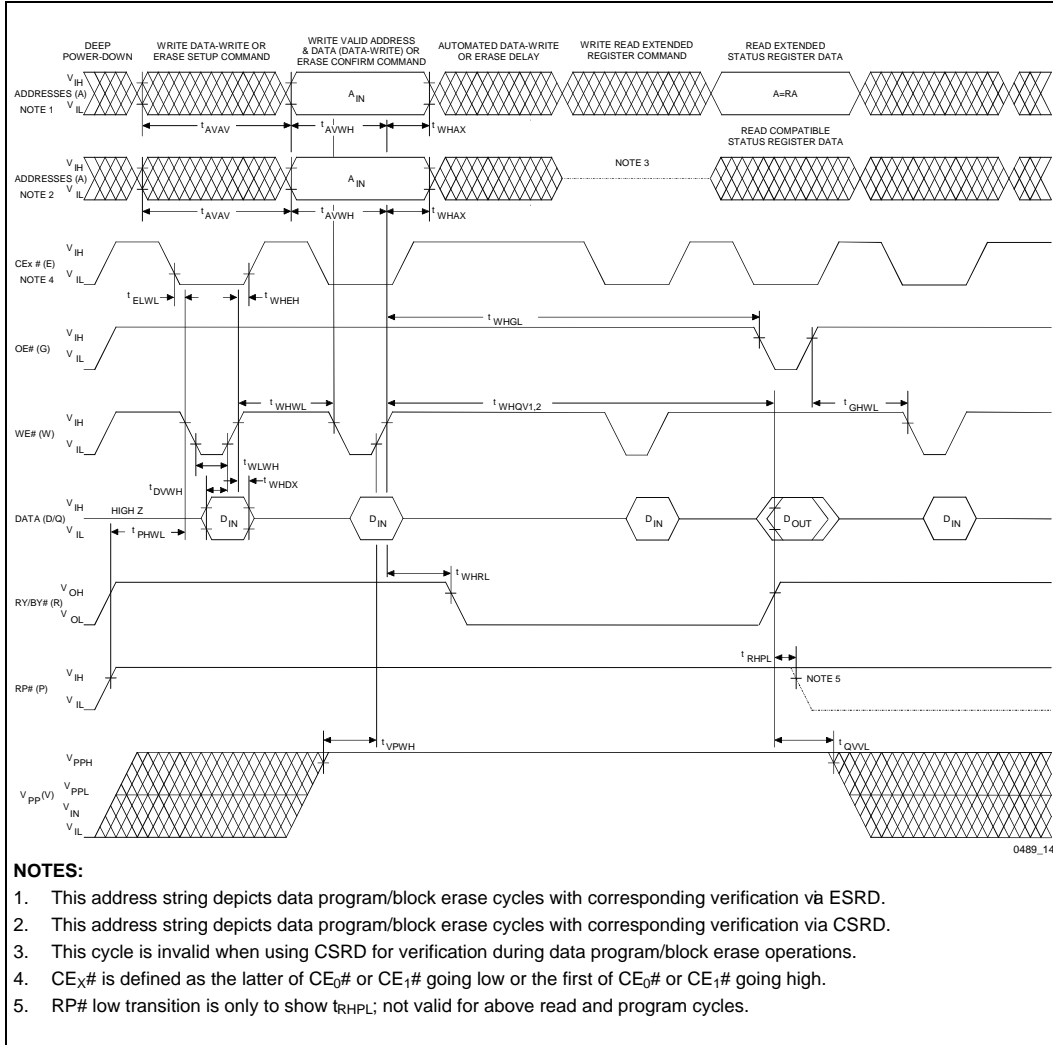

**NOTES:**

1. This address string depicts data program/block erase cycles with corresponding verification via ESRD.
2. This address string depicts data program/block erase cycles with corresponding verification via CSRD.
3. This cycle is invalid when using CSRD for verification during data program/block erase operations.
4. CE<sub>x</sub># is defined as the latter of CE<sub>0</sub># or CE<sub>1</sub># going low or the first of CE<sub>0</sub># or CE<sub>1</sub># going high.
5. RP# low transition is only to show t<sub>RHPL</sub>; not valid for above read and program cycles.

**Figure 15. AC Waveforms for Command Write Operations**

### 5.9 AC Characteristics for CE#–Controlled Command Write Operations: COMMERCIAL AND EXTENDED TEMPERATURE(1)

V<sub>CC</sub> = 3.3V ±10%, T<sub>A</sub> = 0°C to +70°C, -40°C to +85°C

Sym	Parameter	Temp	Commercial			Comm/Ext			Unit
		Speed	-120			-150			
		Notes	Min	Typ	Max	Min	Typ	Max	
t <sub>AVAV</sub>	Write Cycle Time		120			150			ns
t <sub>VPEH</sub>	V <sub>PP</sub> Setup to CE# Going High	3	100			100			ns
t <sub>PHWL</sub>	RP# Setup to WE# Going Low		480			480			ns
t <sub>WLEL</sub>	WE# Setup to CE# Going Low		0			0			ns
t <sub>AVEH</sub>	Address Setup to CE# Going High	2,6	75			75			ns
t <sub>DVEH</sub>	Data Setup to CE# Going High	2,6	75			75			ns
t <sub>ELEH</sub>	CE# Pulse Width		75			75			ns
t <sub>EHDX</sub>	Data Hold from CE# High	2	10			10			ns
t <sub>EHAX</sub>	Address Hold from CE# High	2	10			10			ns
t <sub>EHWH</sub>	WE Hold from CE# High		10			10			ns
t <sub>EHEL</sub>	CE# Pulse Width High		45			75			ns
t <sub>GHEL</sub>	Read Recovery before Write		0			0			ns
t <sub>EHRL</sub>	CE# High to RY/BY# Going Low				100			100	ns
t <sub>RHPL</sub>	RP# Hold from Valid Status Register (CSR, GSR, BSR) Data and RY/BY# High	3	0			0			ns
t <sub>PHEL</sub>	RP# High Recovery to CE# Going Low		1			1			µs
t <sub>EHGL</sub>	Write Recovery before Read		95			120			ns
t <sub>QVVL</sub>	V <sub>PP</sub> Hold from Valid Status Register (CSR, GSR, BSR) Data and RY/BY# High		0			0			µs
t <sub>EHQV1</sub>	Duration of Word/Byte Program Operation	4,5	5	9	Note 7	5	9	Note 7	µs
t <sub>EHQV2</sub>	Duration of Block Erase Operation	4	0.3		10	0.3		10	sec

**5.9 AC Characteristics for CE#–Controlled Command Write Operations:  
COMMERCIAL AND EXTENDED TEMPERATURE<sup>(1)</sup>** (Continued)

 $V_{CC} = 5.0 \text{ to } 10\%$ ,  $5.0 \pm 5\%$ ,  $T_A = 0^\circ\text{C to } +70^\circ\text{C}$ ,  $-40^\circ\text{C to } +85^\circ\text{C}$ 

Versions		Temp	Commercial			Commercial			Comm/Ext			Unit
		$V_{CC} \pm 5\%$	28F016SA-070									
		$V_{CC} \pm 10\%$				28F016SA-080			28F016SA-100			
Sym	Parameter	Notes	Min	Typ	Max	Min	Typ	Max	Min	Typ	Max	
t <sub>AVAV</sub>	Write Cycle Time		70			80			100			ns
t <sub>VPEH</sub>	V <sub>PP</sub> Setup to CE# Going High	3	100			100			100			ns
t <sub>PHWL</sub>	RP# Setup to WE# Going Low	3	480			480			480			ns
t <sub>WLEL</sub>	WE# Setup to CE# Going Low		0			0			0			ns
t <sub>AVEH</sub>	Address Setup to CE# Going High	2,6	50			50			50			ns
t <sub>DVEH</sub>	Data Setup to CE# Going High	2,6	50			50			50			ns
t <sub>ELEH</sub>	CE# Pulse Width		40			50			50			ns
t <sub>EHDX</sub>	Data Hold from CE# High	2	0			0			0			ns
t <sub>EHAX</sub>	Address Hold from CE# High	2	10			10			10			ns
t <sub>EHWH</sub>	WE# Hold from CE# High		10			10			10			ns
t <sub>EHEL</sub>	CE# Pulse Width High		30			30			50			ns
t <sub>GHEL</sub>	Read Recovery before Write		0			0			0			ns
t <sub>EHRL</sub>	CE# High to RY/BY# Going Low				100			100			100	ns

### 5.9 AC Characteristics for CE#–Controlled Command Write Operations: COMMERCIAL AND EXTENDED TEMPERATURE<sup>(1)</sup> (Continued)

V<sub>CC</sub> = 5.0 to 10%, 5.0V ± 5%, T<sub>A</sub> = 0°C to +70°C, –40°C to +85°C

Versions		Temp	Commercial			Commercial			Comm/Ext			Unit
		V <sub>CC</sub> ± 5%	28F016SA-070									
		V <sub>CC</sub> ± 10%				28F016SA-080			28F016SA-100			
Sym	Parameter	Notes	Min	Typ	Max	Min	Typ	Max	Min	Typ	Max	
t <sub>RHPL</sub>	RP# Hold from Valid Status Register (CSR, GSR, BSR) Data and RY/BY# High	3	0			0			0			ns
t <sub>PHL</sub>	RP# High Recovery to CE# Going Low		1			1			1			μs
t <sub>EHGL</sub>	Write Recovery before Read		60			65			80			μs
t <sub>QVVL</sub>	V <sub>PP</sub> Hold from Valid Status Register (CSR, GSR, BSR) Data and RY/BY# High		0			0			0			μs
t <sub>EHQV1</sub>	Duration of Word/Byte Program Operation	4,5	4.5	6	Note 7	4.5	6	Note 7	4.5	6	Note 7	μs
t <sub>EHQV2</sub>	Duration of Block Erase Operation	4	0.3		10	0.3		10	0.3		10	sec

#### NOTES:

CE# is defined as the latter of CE<sub>0</sub># or CE<sub>1</sub># going low or the first of CE<sub>0</sub># or CE<sub>1</sub># going high.

1. Read timings during data program and block erase are the same as for normal read.
2. Refer to command definition tables for valid address and data values.
3. Sampled, but not 100% tested.
4. Data program/block erase durations are measured to valid Status Register data.
5. Word/byte program operations are typically performed with 1 programming pulse.
6. Address and data are latched on the rising edge of CE# for all command write operations.
7. This information will be available in a technical paper. Please call Intel's Application Hotline or your local Intel sales office for more information.



### 5.10 AC Characteristics for Page Buffer Write Operations: COMMERCIAL AND EXTENDED TEMPERATURE(1)

$V_{CC} = 3.3V \pm 10\%$ ,  $T_A = 0^\circ C$  to  $+70^\circ C$ ,  $-40^\circ C$  to  $+85^\circ C$

Sym	Parameter	Temp	Commercial			Comm/Ext			Unit
		Speed	-120			-150			
		Notes	Min	Typ	Max	Min	Typ	Max	
t <sub>AVAV</sub>	Write Cycle Time		120			150			ns
t <sub>ELWL</sub>	CE# Setup to WE# Going Low		10			10			ns
t <sub>AVWL</sub>	Address Setup to WE# Going Low	3	0			0			ns
t <sub>DVWH</sub>	Data Setup to WE# Going High	2	75			75			ns
t <sub>WLWH</sub>	WE# Pulse Width		75			75			ns
t <sub>WHDX</sub>	Data Hold from WE# High	2	10			10			ns
t <sub>WHAX</sub>	Address Hold from WE# High	2	10			10			ns
t <sub>WHEH</sub>	CE# Hold from WE# High		10			10			ns
t <sub>WHWL</sub>	WE# Pulse Width High		45			75			ns
t <sub>GHWL</sub>	Read Recovery before Write		0			0			ns
t <sub>WHGL</sub>	Write Recovery before Read		95			120			ns

### 5.10 AC Characteristics for Page Buffer Write Operations: COMMERCIAL AND EXTENDED TEMPERATURE<sup>(1)</sup> (Continued)

$V_{CC} = 5.0V \pm 10\%$ ,  $5.0V \pm 5\%$ ,  $T_A = 0^\circ C$  to  $+70^\circ C$ ,  $-40^\circ C$  to  $+85^\circ C$

Sym	Parameter	Temp	Commercial			Commercial			Comm/Ext			Unit
		Speed	-70			-80			-100			
		V <sub>CC</sub>	5.0V ± 5%			5.0V ± 10%			5.0V ± 10%			
		Notes	Min	Typ	Max	Min	Typ	Max	Min	Typ	Max	
t <sub>AVAV</sub>	Write Cycle Time		70			80			100			ns
t <sub>ELWL</sub>	CE# Setup to WE# Going Low		0			0			0			ns
t <sub>AVWL</sub>	Address Setup to WE# Going Low	3	0			0			0			ns
t <sub>DVWH</sub>	Data Setup to WE# Going High	2	50			50			50			ns
t <sub>WLWH</sub>	WE# Pulse Width		40			50			50			ns
t <sub>WHDX</sub>	Data Hold from WE# High	2	0			0			0			ns
t <sub>WHAX</sub>	Address Hold from WE# High	2	10			10			10			ns
t <sub>WHEH</sub>	CE# Hold from WE# High		10			10			10			ns
t <sub>WHWL</sub>	WE# Pulse Width High		30			30			50			ns
t <sub>GHWL</sub>	Read Recovery before Write		0			0			0			ns
t <sub>WHGL</sub>	Write Recovery before Read		60			65			80			ns

**NOTES:**

CE# is defined as the latter of CE<sub>0</sub># or CE<sub>1</sub># going low or the first of CE<sub>0</sub># or CE<sub>1</sub># going high.

1. These are WE#-controlled write timings, equivalent CE#-controlled write timings apply.
2. Sampled, but not 100% tested.
3. Address must be valid during the entire WE# low pulse or the entire CE# low pulse for CE#-controlled writes.

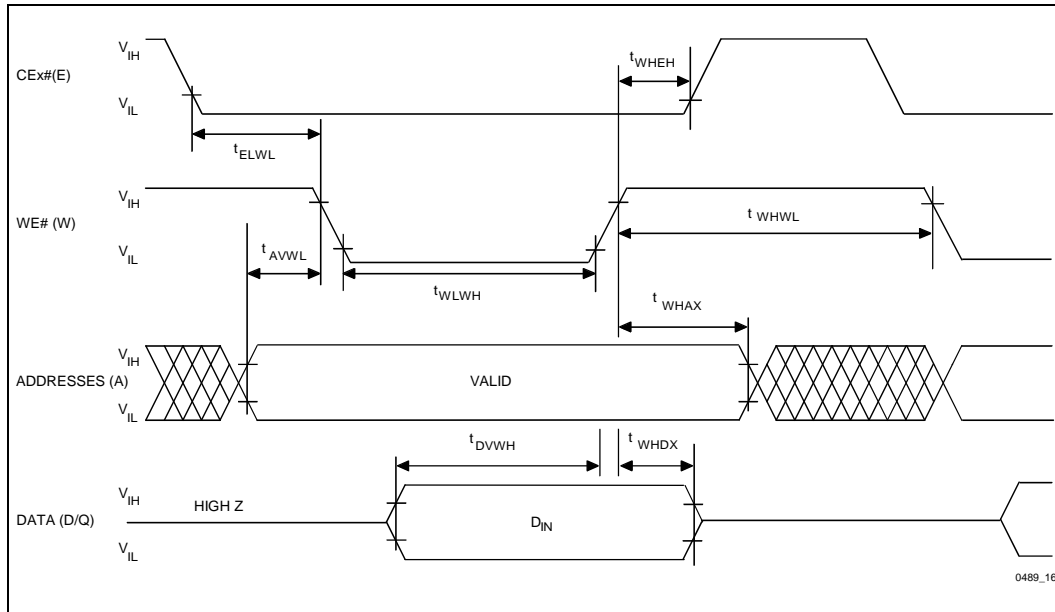

**Figure 17. Page Buffer Write Timing Waveforms  
(Loading Data to the Page Buffer)**





### 5.11 Erase and Word/Byte Write Performance, Cycling Performance and Suspend Latency<sup>(3)</sup>

$V_{CC} = 3.3V \pm 10\%$ ,  $V_{PP} = 12.0V \pm 0.6V$ ,  $T_A = 0^\circ C$  to  $+70^\circ C$

Sym	Parameter	Notes	Min	Typ <sup>(1)</sup>	Max	Units	Test Conditions
	Page Buffer Byte Write Time	2,4		3.26	Note 6	$\mu s$	
	Page Buffer Word Write Time	2,4		6.53	Note 6	$\mu s$	
t <sub>WHRH1</sub>	Word/Byte Program Time	2		9	Note 6	$\mu s$	
t <sub>WHRH2</sub>	Block Program Time	2		0.6	2.1	sec	Byte Prog. Mode
t <sub>WHRH3</sub>	Block Program Time	2		0.3	1.0	sec	Word Prog. Mode
	Block Erase Time	2		0.8	10	sec	
	Full Chip Erase Time	2		25.6		sec	
	Erase Suspend Latency Time to Read			7.0		$\mu s$	
	Auto Erase Suspend Latency Time to Write			10.0		$\mu s$	
	Erase Cycles	5	100,000	1,000,000		Cycles	

$V_{CC} = 5.0V \pm 10\%$ ,  $V_{PP} = 12.0V \pm 0.6V$ ,  $T_A = 0^\circ C$  to  $+70^\circ C$

Sym	Parameter	Notes	Min	Typ <sup>(1)</sup>	Max	Units	Test Conditions
	Page Buffer Byte Write Time	2,4		2.76	Note 6	$\mu s$	
	Page Buffer Word Write Time	2,4		5.51	Note 6	$\mu s$	
t <sub>WHRH1</sub>	Word/Byte Program Time	2		6	Note 6	$\mu s$	
t <sub>WHRH2</sub>	Block Program Time	2		0.4	2.1	sec	Byte Prog. Mode
t <sub>WHRH3</sub>	Block Program Time	2		0.2	1.0	sec	Word Prog. Mode
	Block Erase Time	2		0.6	10	sec	
	Full Chip Erase Time	2		19.2		sec	
	Erase Suspend Latency Time to Read			5.0		$\mu s$	
	Auto Erase Suspend Latency Time to Write			8.0		$\mu s$	
	Erase Cycles	5	100,000	1,000,000		Cycles	

#### NOTES:

- +25°C,  $V_{CC} = 3.3V$  or  $5.0V$  nominal,  $V_{PP} = 12.0V$  nominal, 10K cycles.
- Excludes system-level overhead.
- These performance numbers are valid for all speed versions.
- This assumes using the full Page Buffer to data program to the flash memory (256 bytes or 128 words).
- Typical 1,000,000 cycle performance assumes the application uses block retirement techniques.
- This information will be available in a technical paper. Please call Intel's Application Hotline or your local Intel Sales office for more information.

6.0 DERATING CURVES

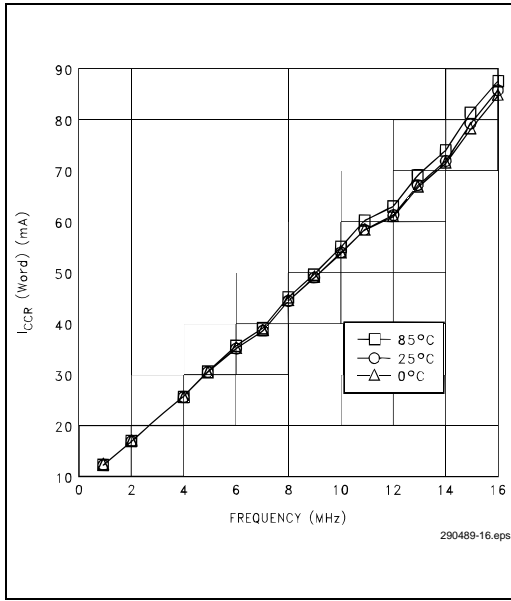

Figure 18. I<sub>CC</sub> vs. Frequency (V<sub>CC</sub> = 5.5V) for x8 or x16 Operation

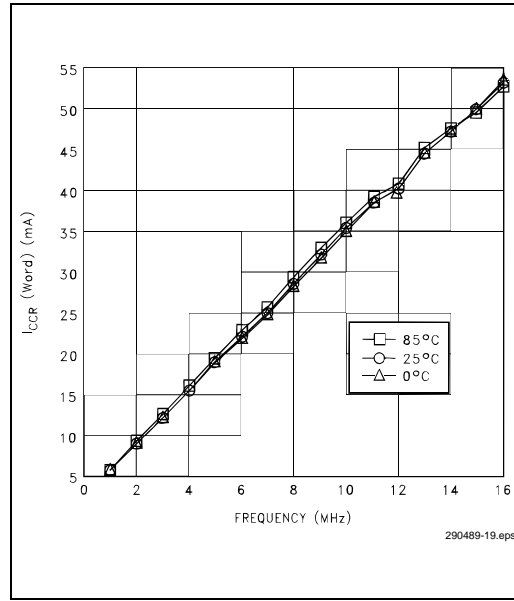

Figure 20. I<sub>CC</sub> vs. Frequency (V<sub>CC</sub> = 3.6V) for x8 or x16 Operation

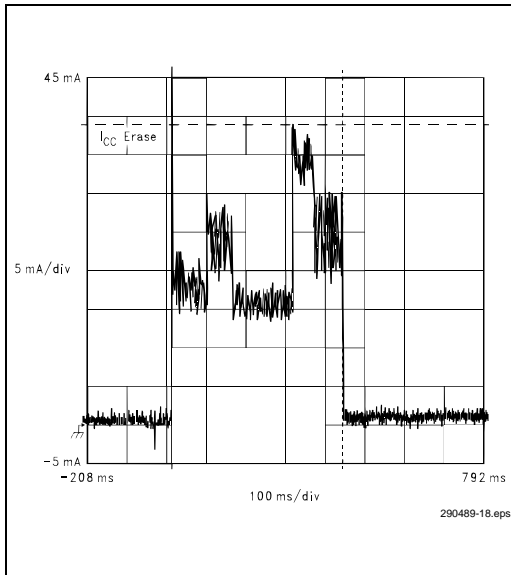

Figure 19. I<sub>CC</sub> during Block Erase

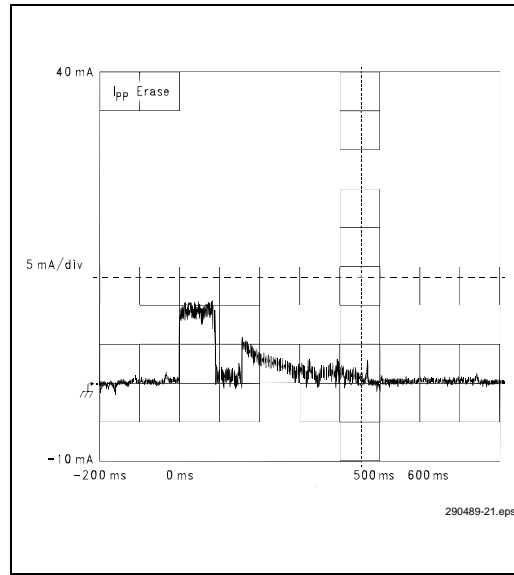

Figure 21. I<sub>PP</sub> during Block Erase

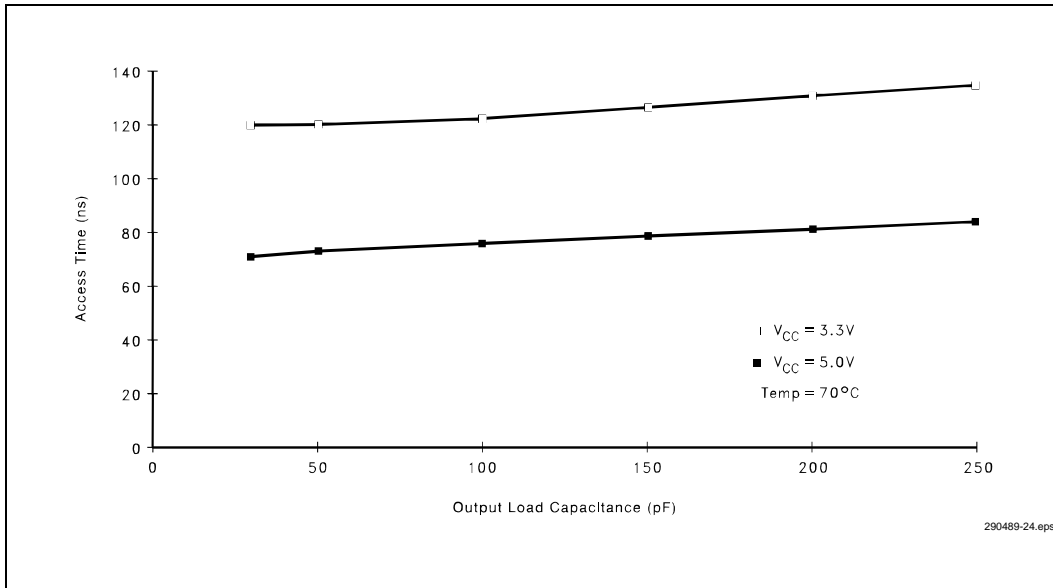

Figure 22. Access Time (t<sub>ACC</sub>) vs. Output Loading

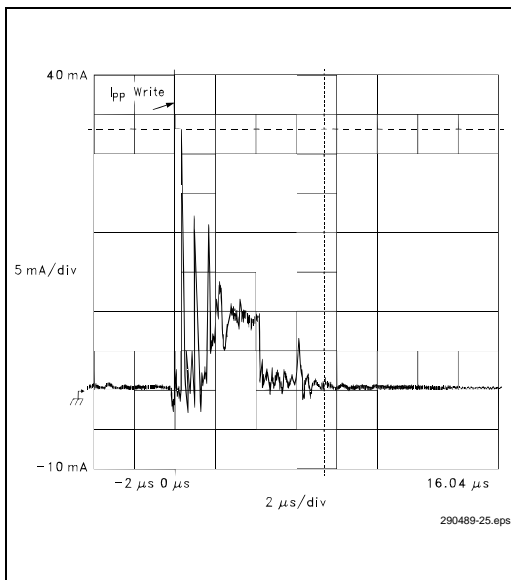

Figure 23. I<sub>PP</sub> during Word Write Operation

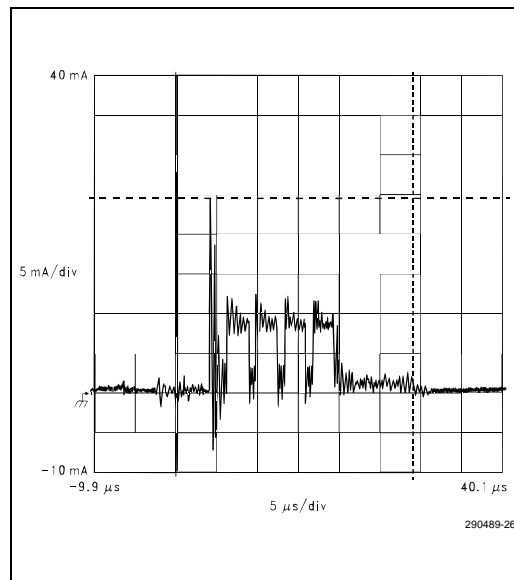

Figure 24. I<sub>PP</sub> during Page Buffer Write Operation



7.0 MECHANICAL SPECIFICATIONS FOR TSOP

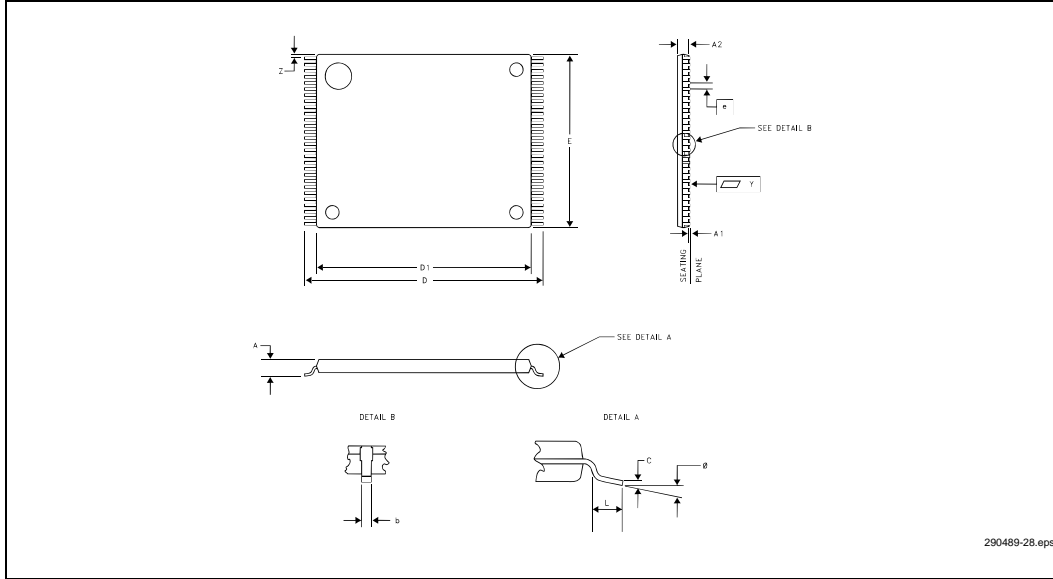

Figure 25. Mechanical Specifications of the 28F016SA 56-Lead TSOP Type 1 Package

Family: Thin Small Outline Package				
Symbol	Millimeters			Notes
	Minimum	Nominal	Maximum	
A			1.20	
A <sub>1</sub>	0.05			
A <sub>2</sub>	0.965	0.995	1.025	
b	0.100	0.150	0.200	
c	0.115	0.125	0.135	
D <sub>1</sub>	18.20	18.40	18.60	
E	13.80	14.00	14.20	
e		0.50		
D	19.80	20.00	20.20	
L	0.500	0.600	0.700	
N		56		
∅	0°	3°	5°	
Y			0.100	
Z	0.150	0.250	0.350	

8.0 MECHANICAL SPECIFICATIONS FOR SSOP

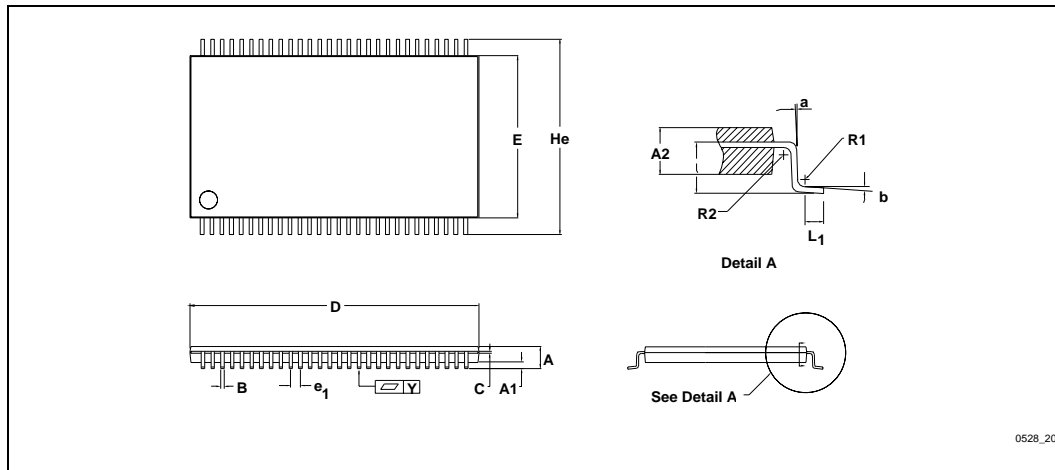

Figure 26. Mechanical Specifications of the 56-Lead SSOP Package

Family: Shrink Small Outline Package				
Symbol	Millimeters			Notes
	Minimum	Nominal	Maximum	
A		1.80	1.90	
A1	0.47	0.52	0.57	
A2	1.18	1.28	1.38	
B	0.25	0.30	0.40	
C	0.13	0.15	0.20	
D	23.40	23.70	24.00	
E	13.10	13.30	13.50	
e <sub>1</sub>		0.80		
He	15.70	16.00	16.30	
N		56		
L <sub>1</sub>	0.45	0.50	0.55	
Y			0.10	
a	2°	3°	4°	
b	3°	3°	5°	
R1	0.15	0.20	0.25	
R2	0.15	0.20	0.25	

## APPENDIX A DEVICE NOMENCLATURE AND ORDERING INFORMATION

<div style="display: flex; justify-content: space-around; font-family: monospace; font-size: 1.2em; border: 1px solid black; padding: 5px;"> <span>D</span><span>A</span><span>2</span><span>8</span><span>F</span><span>0</span><span>1</span><span>6</span><span>S</span><span>A</span><span>-</span><span>0</span><span>7</span><span>0</span> </div>
<div style="display: flex; justify-content: space-between; margin-bottom: 10px;"> <div style="text-align: center;"> <p>┌───┐</p> <p>└───┘</p> </div> <div style="text-align: center;"> <p>┌───┐</p> <p>└───┘</p> </div> </div> <div style="display: flex; justify-content: space-between;"> <div style="width: 60%;"> <p>DA = Commercial Temperature 56-Lead SSOP</p> <p>E = Commercial Temperature 56-Lead TSOP</p> <p>T = Extended Temperature 56-Lead SSOP</p> </div> <div style="width: 35%; text-align: center;"> <p>ACCESS SPEED</p> <p>70 ns</p> <p>100 ns</p> <p>100 ns</p> </div> </div>
0489_16

Option	Order Code	Valid Combinations		
		V <sub>CC</sub> = 3.3V ± 10%, 50 pF Load	V <sub>CC</sub> = 5.0V ± 10%, 100 pF Load	V <sub>CC</sub> = 5.0V ± 5%, 30 pF Load
1	E28F016SA-070	E28F016SA-120	E28F016SA-080	E28F016SA-070
2	E28F016SA-100	E28F016SA-150	E28F016SA-100	
3	DA28F016SA-070	DA28F016SA-120	DA28F016SA-080	DA28F016SA-070
4	DA28F016SA-100	DA28F016SA-150	DA28F016SA-100	
5	DT28F016SA-100	DT28F016SA-150	DT28F016SA-150	DT28F016SA-150

## APPENDIX B ADDITIONAL INFORMATION(1,2)

Order Number	Document/Tool
297372	<i>16-Mbit Flash Product Family User's Manual</i>
290490	<i>DD28F032SA 32-Mbit FlashFile™ Memory Datasheet</i>
290528	<i>28F016SV FlashFile™ Memory Datasheet</i>
290429	<i>28F008SA 8-Mbit FlashFile™ Memory Datasheet</i>
292092	<i>AP-357 Power Supply Solutions for Flash Memory</i>
292123	<i>AP-374 Flash Memory Write Protection Techniques</i>
292126	<i>AP-377 16-Mbit Flash Product Family Software Drivers 28F016SA, 28F016SV, 28F016XS, 28F016XD</i>
292144	<i>AP-393 28F016SV Compatibility with 28F016SA</i>
292159	<i>AP-607 Multi-Site Layout Planning with Intel's Flash File™ Components</i>
294016	<i>ER-33 ETOX™ Flash Memory Technology - Insight to Intel's Fourth Generation Process Innovation</i>
297534	<i>Small and Low-Cost Power Supply solution for Intel's Flash Memory Products (Technical Paper)</i>
297508	FLASHBuilder Design Resource Tool

**NOTES:**

1. Please call the Intel Literature Center at (800) 548-4725 to request Intel documentation. International customers should contact their local Intel or distribution sales office.
2. Visit Intel's World Wide Web home page at <http://www.Intel.com> for technical documentation and tools.