

## Technische Information / Technical Information

eupec

Netz-Dioden-Modul  
Rectifier Diode Module

DD B6U 85 N 12...18 (ISOPACK)

N  B6

## Elektrische Eigenschaften / Electrical properties

Höchstzulässige Werte / Maximum rated values

Periodische Spitzensperrspannung repetitive peak reverse voltage	$T_{vj} = -40^{\circ}\text{C} \dots T_{vj\text{max}}$	$V_{RRM}$	1200, 1400 1600, 1800	V V
Stoßspitzensperrspannung non-repetitive peak reverse voltage	$T_{vj} = +25^{\circ}\text{C} \dots T_{vj\text{max}}$	$V_{RSM}$	1300, 1500 1700, 1900	V V
Durchlaßstrom-Grenzeffektivwert (pro Element) RMS forward current (per chip)		$I_{FRMSM}$	60	A
Ausgangsstrom output current	$T_C = 100^{\circ}\text{C}$ $T_C = 84^{\circ}\text{C}$ $T_A = 45^{\circ}\text{C}$ , KM 11 $T_A = 45^{\circ}\text{C}$ , KM 33 $T_A = 35^{\circ}\text{C}$ , KM 14 ( $V_L = 45\text{l/s}$ ) $T_A = 35^{\circ}\text{C}$ , KM 33 ( $V_L = 90\text{l/s}$ )	$I_d$	85 104 58 75 104 104	A A A A A A
Stoßstrom-Grenzwert surge forward current	$T_{vj} = 25^{\circ}\text{C}$ , $t_p = 10\text{ms}$ $T_{vj} = T_{vj\text{max}}$ , $t_p = 10\text{ms}$	$I_{FSM}$	650 550	A A
Grenzlastintegral $I^2t$ -value	$T_{vj} = 25^{\circ}\text{C}$ , $t_p = 10\text{ms}$ $T_{vj} = T_{vj\text{max}}$ , $t_p = 10\text{ms}$	$I^2t$	2100 1500	$\text{A}^2\text{s}$ $\text{A}^2\text{s}$

Charakteristische Werte / Characteristic values

Durchlaßspannung forward voltage	$T_{vj} = T_{vj\text{max}}$ , $i_F = 100\text{A}$	$V_F$	max. 1,44	V
Schleusenspannung threshold voltage	$T_{vj} = T_{vj\text{max}}$	$V_{(TO)}$	0,75	V
Ersatzwiderstand forward slope resistance	$T_{vj} = T_{vj\text{max}}$	$r_T$	5,5	$\text{m}\Omega$
Sperrstrom reverse current	$T_{vj} = T_{vj\text{max}}$ , $V_R = V_{RRM}$	$i_R$	max. 5	mA
Isolations-Prüfspannung insulation test voltage	RMS, $f = 50\text{Hz}$ , $t = 1\text{min}$ RMS, $f = 50\text{Hz}$ , $t = 1\text{sec}$	$V_{ISOL}$	3,0 3,6	kV kV

## Thermische Eigenschaften / Thermal properties

Innerer Wärmewiderstand thermal resistance, junction to case	pro Modul / per module, $\Theta = 120^{\circ}\text{rect}$ pro Element / per chip, $\Theta = 120^{\circ}\text{rect}$ pro Modul / per module, DC pro Element / per chip, DC	$R_{thJC}$	max. 0,241 max. 1,450 max. 0,183 max. 1,100	$^{\circ}\text{C/W}$ $^{\circ}\text{C/W}$ $^{\circ}\text{C/W}$ $^{\circ}\text{C/W}$
Übergangs-Wärmewiderstand thermal resistance, case to heatsink	pro Modul / per module pro Element / per chip	$R_{thCK}$	max. 0,033 max. 0,200	$^{\circ}\text{C/W}$ $^{\circ}\text{C/W}$
Höchstzulässige Sperrschichttemperatur max. junction temperature		$T_{vj\text{max}}$	150	$^{\circ}\text{C}$
Betriebstemperatur operating temperature		$T_{c\text{op}}$	-40...+150	$^{\circ}\text{C}$
Lagertemperatur storage temperature		$T_{stg}$	-40...+150	$^{\circ}\text{C}$

## Technische Information / Technical Information

eupec

Netz-Dioden-Modul  
Rectifier Diode Module

DD B6U 85 N 12...18 (ISOPACK)

N



B6

## Mechanische Eigenschaften / Mechanical properties

Gehäuse, siehe Anlage case, see appendix			Seite 3 page 3	
Si-Elemente mit Lötkontakt, glaspassiviert Si-pellets with soldered contact, glass-passivated				
Innere Isolation internal insulation			Al <sub>2</sub> O <sub>3</sub>	
Anzugsdrehmoment für mechanische Befestigung mounting torque	Toleranz / tolerance ±15%	M1	6	Nm
Anzugsdrehmoment für elektrische Anschlüsse terminal connection torque	Toleranz / tolerance +5% / -10%	M2	4	Nm
Gewicht weight		G	typ. 220	g
Kriechstrecke creepage distance			12,5	mm
Schwingfestigkeit vibration resistance	f = 50Hz		50	m/s <sup>2</sup>

Kühlkörper / heatsinks : KM 11; KM 14; KM 17; KM 33

www.DataSheet4U.com

Mit dieser technischen Information werden Halbleiterbauelemente spezifiziert, jedoch keine Eigenschaften zugesichert. Sie gilt in Verbindung mit den zugehörigen Technischen Erläuterungen. / This technical information specifies semiconductor devices but promises no characteristics. It is valid in combination with the belonging technical notes.

## Technische Information / Technical Information

eupec

Netz-Dioden-Modul  
Rectifier Diode Module

DD B6U 85 N 12...18 (ISOPACK)

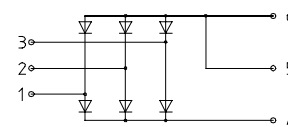
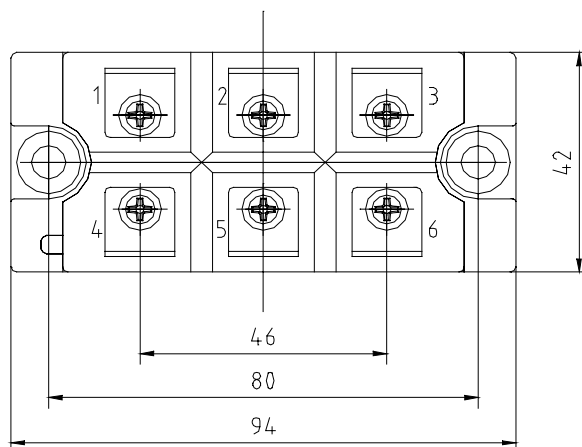
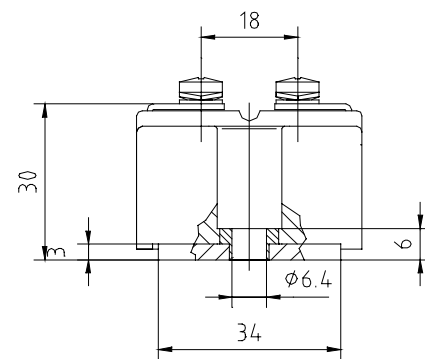
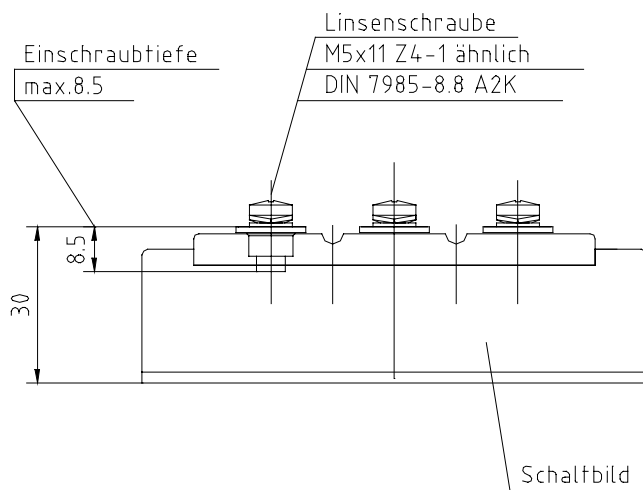
N  B6

## Technische Information / Technical Information

eupec

Netz-Dioden-Modul  
Rectifier Diode Module

DD B6U 85 N 12...18 (ISOPACK)

N  B6Analytische Elemente des transienten Wärmewiderstandes  $Z_{thJC}$  für DCAnalytical elements of transient thermal impedance  $Z_{thJC}$  for DC

Pos. n	1	2	3	4	5	6	7
$R_{thn} [^{\circ}C / W]$	0,60300	0,35000	0,06700	0,08400			
$\tau_n [s]$	0,30200	0,03780	0,00400	0,00109			

Analytische Funktion: 
$$Z_{thJC} = \sum_{n=1}^{n_{max}} R_{thn} \left( 1 - e^{-\frac{t}{\tau_n}} \right)$$

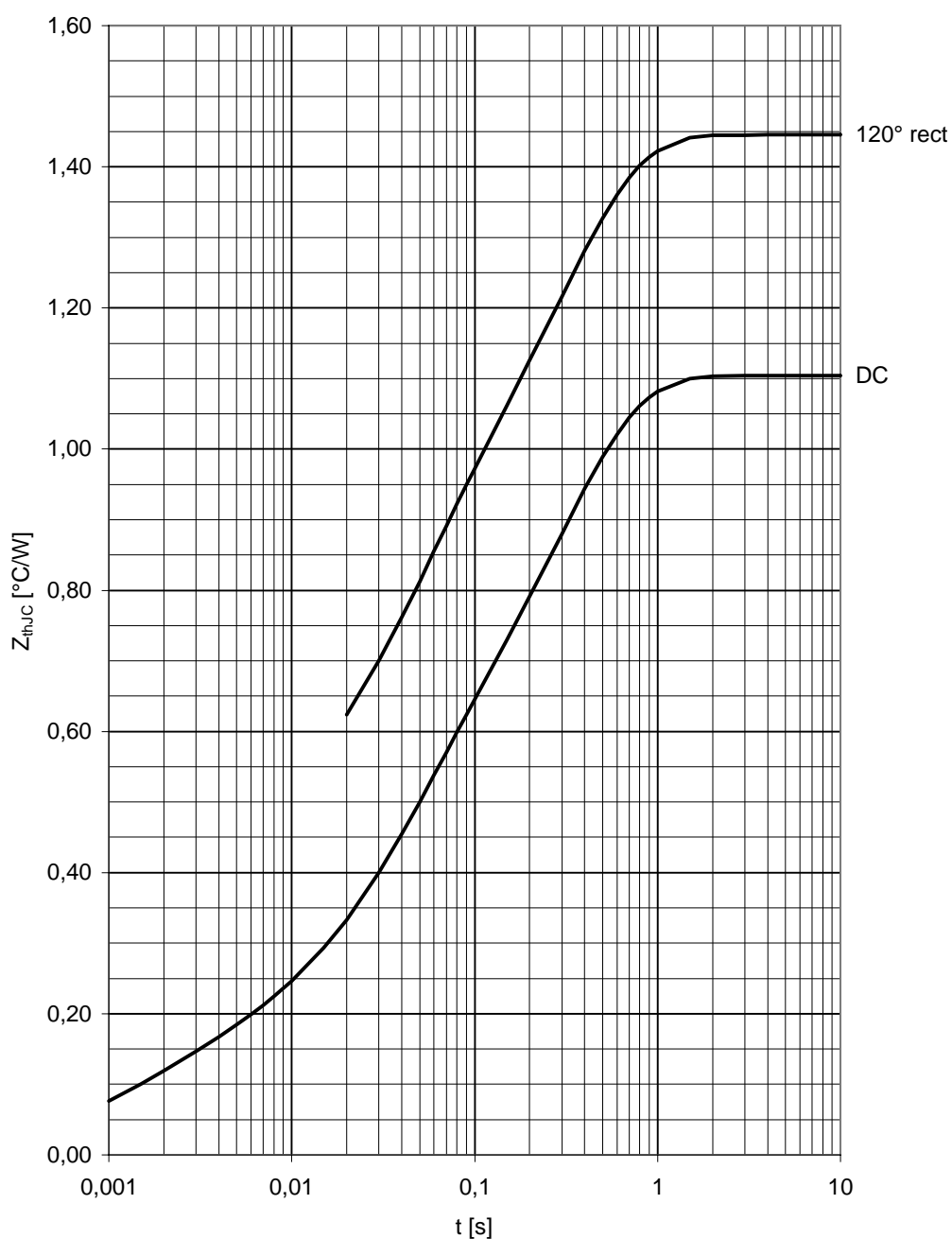

Transienter innerer Wärmewiderstand je Zweig / Transient thermal impedance per arm,  $Z_{thJC} = f(t)$   
 Parameter: Stromflußwinkel / Current conduction angle  $\theta$

Netz-Dioden-Modul  
Rectifier Diode Module

DD B6U 85 N 12...18 (ISOPACK)

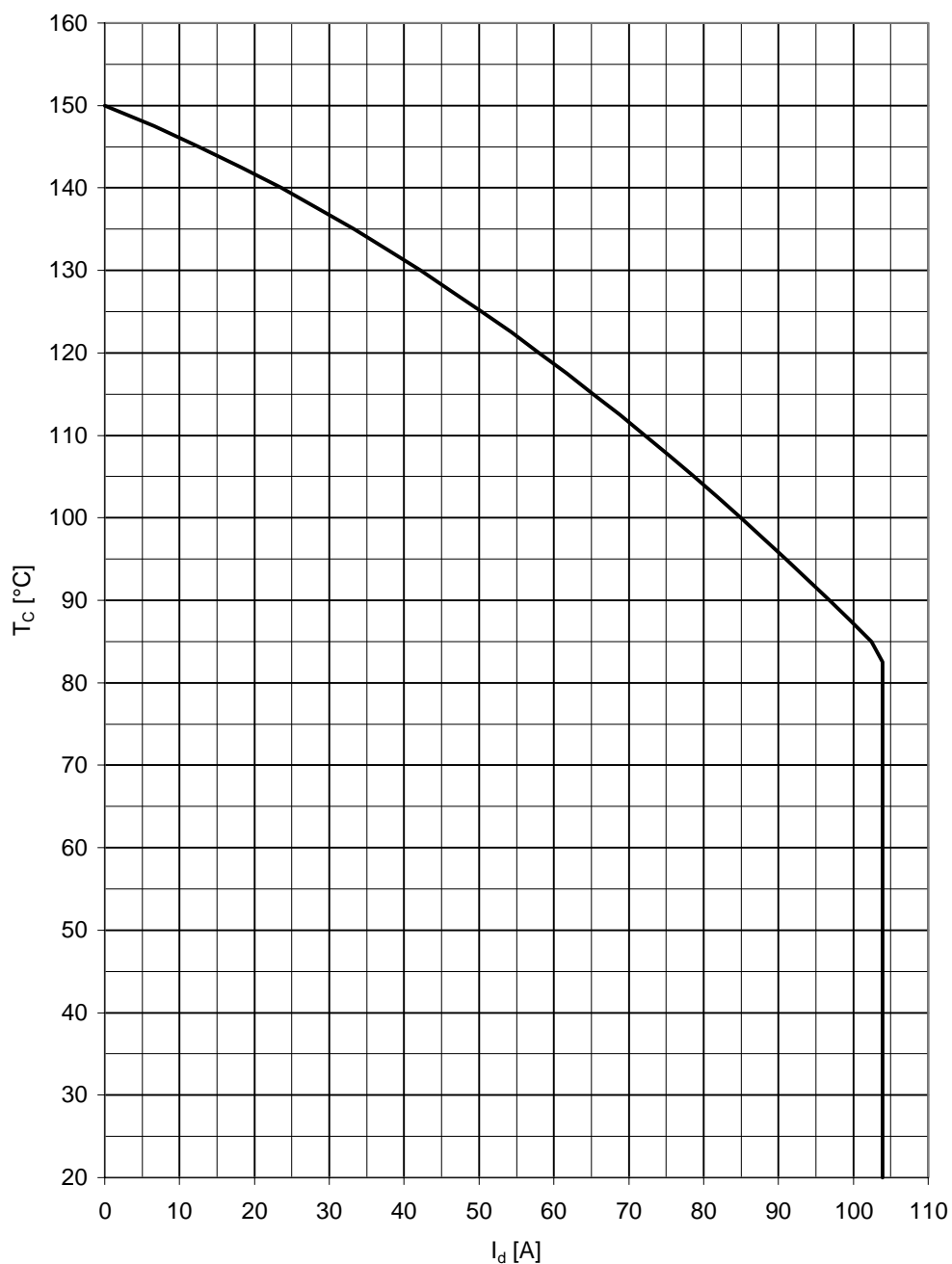
N  B6Höchstzulässige Gehäusetemperatur / Maximum allowable case temperature  $T_c = f(I_d)$